

# PERKO

We Make It Right. Right Here.

## CATALOG NO. 275

## 1995 - 1996

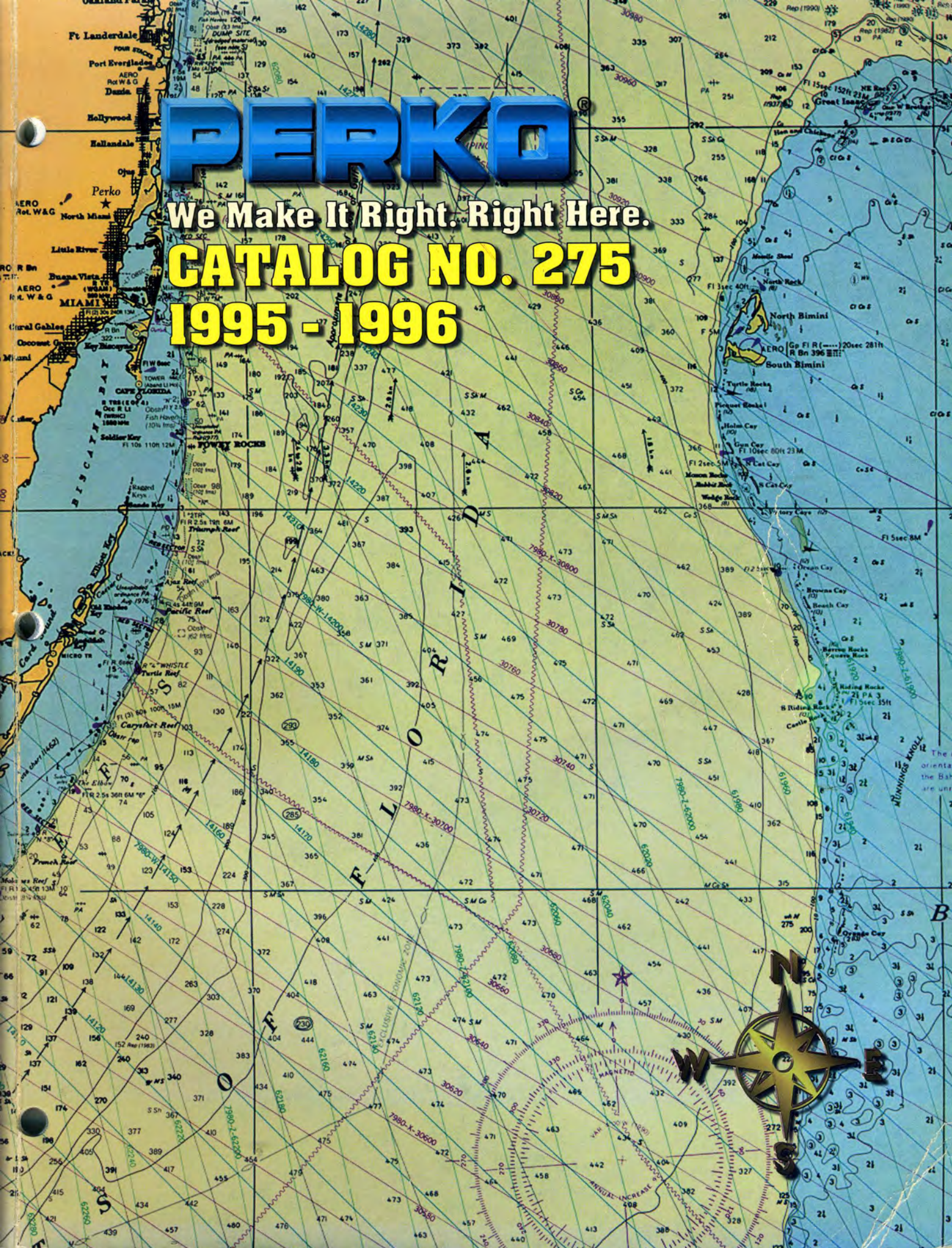



*Started by Frederick Perkins in the late 1880's and later moved into a small plant in New York City, four generations later PERKO, Inc. is still a private family owned and operated corporation. Housed in a modern facility of over 350,000 square feet in Miami, Florida, this close control continues to allow us to respond quickly to the needs of our customers and changing market demands.*

*Our philosophy has always emphasized a long term commitment to quality leadership in the marine industry. Our employees are an integral part of our business family, dedicated to manufacturing the highest quality marine products.*

*PERKO is a truly vertically integrated manufacturer, producing most components from raw materials. This has enabled us to meet our objective of providing our customers with the highest quality marine lights, hardware and accessories at competitive market prices.*



# PERKO



# PERKO®

WE MAKE IT RIGHT, RIGHT HERE. . .

## CATALOG NO. 275 1995 - 1996

### STREET ADDRESS

16490 NORTHWEST 13TH AVENUE  
MIAMI, FLORIDA 33169-5707

### MAILING ADDRESS

P.O. Box 64000D  
MIAMI, FLORIDA 33164-0510

### TELEPHONE NUMBER

(305) 621-7525

### FAX NUMBER

(305) 620-9978

© Perko, Inc. 1994  
All Rights Reserved

Portions of this Catalog  
Previously Copyrighted in  
1936 - 1992 Inclusive



**THE DIFFERENCE IS DISTINCTIVE®**

MANUFACTURER OF  
SHIP AND BOAT EQUIPMENT

NAVIGATION LIGHTS FOR  
VESSELS UNDER 20 METERS  
1 - 35

NAVIGATION LIGHTS FOR  
VESSELS OVER 20 METERS  
36 - 44

SEARCHLIGHTS  
45 - 60

ELECTRICAL SWITCHES,  
LIGHTING FIXTURES,  
BULBS  
61 - 79

COMPARTMENT VENTILATORS,  
FUEL VENTS & BELLS  
80 - 87

PIPE & HOSE DECK PLATES,  
UNDERWATER FITTINGS,  
STRAINERS & FILTERS  
88 - 108

DECK HARDWARE, CLEATS,  
CHOCKS, BITTS, BOW EYES,  
ROWLOCKS, WINDSHIELD &  
HATCH ADJUSTERS  
109 - 143

CABINET & DOOR  
HARDWARE,  
LOCKS & LATCHES,  
HINGES, HOOKS ETC.  
144 - 176

FISHING EQUIPMENT  
177 - 186



# GENERAL INFORMATION

## SALES POLICY

PERKO Products are sold through our established Distributors. We do not sell direct to the public or organizations. Therefore, possession of this catalog does not infer an offer to sell. Please contact your local marine supplier.

## PRICES AND TERMS

Our costs are subject to change due to causes beyond our control. Therefore, our price list is only intended for the guidance of our customers and does not necessarily establish current prices. *A Repackaging Service Charge of \$5.00 net will apply to all broken packages.* All prices are subject to change without notice. Terms are 2% 10 days, net 30 days.

Orders from firms having no satisfactory history or credit rating with us must be prepaid. C.O.D. shipments will be made if a 25% deposit is sent with order. Cash discounts do not apply to C.O.D. shipments.

## ONE YEAR LIMITED WARRANTY

PERKO, INC. (PERKO) warrants to the original consumer-purchaser that PERKO'S consumer products will be free from defective materials or workmanship, under normal use and service, for a period of one (1) year from the original purchase date.

All implied warranties, including merchantability, are also limited in duration to the one year period from the original purchase date. PERKO shall not be liable for loss of use of any of its consumer products, nor shall PERKO be liable for other incidental or consequential costs, expenses, or damages incurred by the original consumer-purchaser or by any other person, firm or corporation.

Some states do not allow limitations on how long an implied warranty lasts, so the above limitation may or may not apply to you. Some states do not allow the exclusion or limitation of incidental or consequential damages, so the above limitation or exclusion may not apply to you.

This Warranty is void if the consumer product warranted has been damaged by accident or unreasonable use, neglect, improper service or other cause not arising out of defects in material or workmanship. Excluded from this Warranty are electric light bulbs (lamps), sealed beam units and fuses.

During the warranty period, your PERKO product will either be repaired

or it will be replaced with a like product (at PERKO'S option) without charge to the original consumer-purchaser, when returned prepaid and insured, with proof-of-purchase date to PERKO at our factory in Miami, FL. In the event of replacement, the replacement product will continue the warranty of the original product, or ninety (90) days, whichever is longer. **Important: For this Warranty to be effective PERKO must be supplied with Proof-Of-Purchase date of the product.**

PERKO does not authorize any person or company to create for it any other obligation or liability in connection with any of its products.

This warranty gives you specific legal rights, and you may also have other rights which vary from state to state.

## PERKOPLATE/PERKO•KOTE LIMITED WARRANTY

PERKO, Inc. guarantees that all of its products finished with the PERKOPLATE chromium plating process will maintain their original luster and brightness, or those finished with the PERKO•KOTE powder coating process will remain corrosion-free for as long as the original consumer-purchaser owns them. During the Warranty period, PERKO, Inc. agrees to repair or replace, (at PERKO'S option) without cost to the original consumer-purchaser, any product upon which the PERKOPLATE chromium finish corrodes, becomes dull or otherwise does not maintain its original luster and brightness, or any product upon which the PERKO•KOTE finish corrodes. For this Warranty to be effective, the PERKO product must be returned prepaid and insured, with proof of purchase to PERKO, at our factory in Miami, Florida. **Important: For this Warranty to be effective PERKO must be supplied with Proof-Of-Purchase of the product.**

This Warranty is void if the PERKOPLATE or PERKO•KOTE finish has been damaged by accident, unreasonable use, neglect, improper service or other cause not arising out of defects in material or workmanship. **In no event shall PERKO, INC. be liable for loss of use of its consumer products nor for other incidental or consequential costs, expenses, or damages incurred by the individual.** Some states do not allow the exclusion or limitation of incidental or consequential damage, so the above limitation

may not apply to you. This Warranty gives you specific legal rights, and you may also have other rights which vary from state to state.

## DESIGNS

For the purpose of constant improvement in our products, the designs and specifications are subject to change without notice.

## RETURN GOODS

Products made to order are not returnable. Stock products in new, salable condition are only returnable when permission has been granted by us, and are subject to handling and repackaging charges. Return shipping charges must be prepaid. Purchase date and invoice number are required when requesting an R.G.A. (Return Goods Authorization) number. Permission must be requested within 30 days after receipt of goods.

## WEIGHTS

The weights given in this catalog are approximate, but should be sufficient for general purposes.

## SHIPPING INSTRUCTIONS

Customers should send specific shipping instructions; otherwise, we will use our own judgement in selecting route.

## SHIPMENTS

F.O.B. our plant, Miami, Florida, unless quoted otherwise. We are not responsible for damage, loss or delay after goods are delivered to carrier. When loss or delay occurs, we will gladly assist in tracing or expediting, but such assistance is no criterion of responsibility.

When there is loss or apparent visible damage to a shipment, when tendered for delivery, do not give the carrier a clear receipt. Note such damage on the carrier's delivery receipt and have the driver sign the receipt.

## CONCEALED DAMAGE OR LOSS

1. Advise the delivering carrier in writing as soon as discovered or at least no more than 15 days after delivery, and request carrier to make an inspection.
2. Retain for the carrier's inspection, the container and all packaging that the damaged or lost material was packaged in.
3. Shortages - Must be reported to us within 15 days after receipt of goods.



# OUR MODERN SELF-CONTAINED FACILITY



**HOME OF PERKO, INC**  
**MODERN 350,000 SQ.FT. FACILITY LOCATED ON 16 ACRES**  
**IN MIAMI, FLORIDA**



**Above:**  
**Computerized**  
**Tool and Die**  
**Department**

**Below:**  
**Quality Control Lab Utilizing**  
**Atomic Absorption**  
**Spectrophotometry**





# OUR MODERN SELF-CONTAINED FACILITY

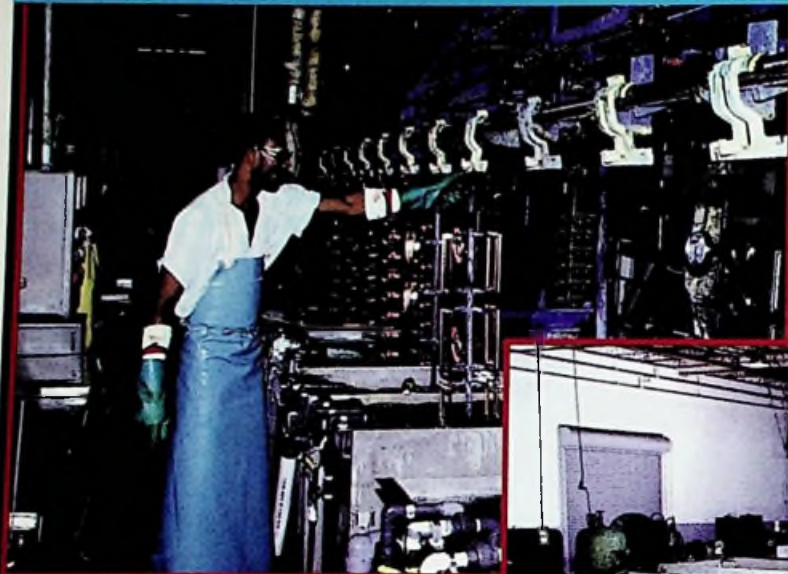

**Top Left:**  
**PERKOPLATE**  
**Plating Department**

**Below:**  
**Die Cast**  
**Department**

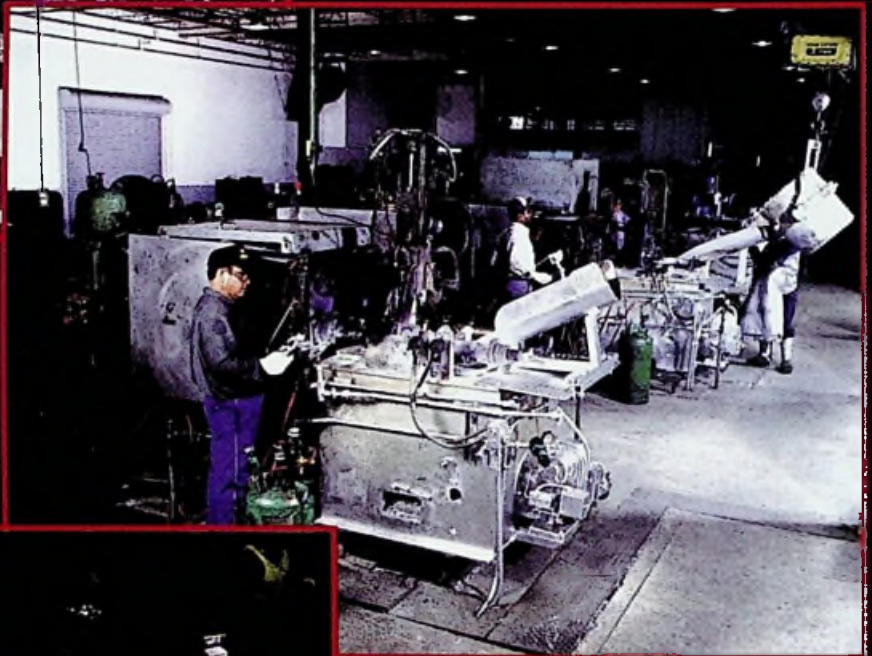

**Below:**  
**Searchlight**  
**Department**

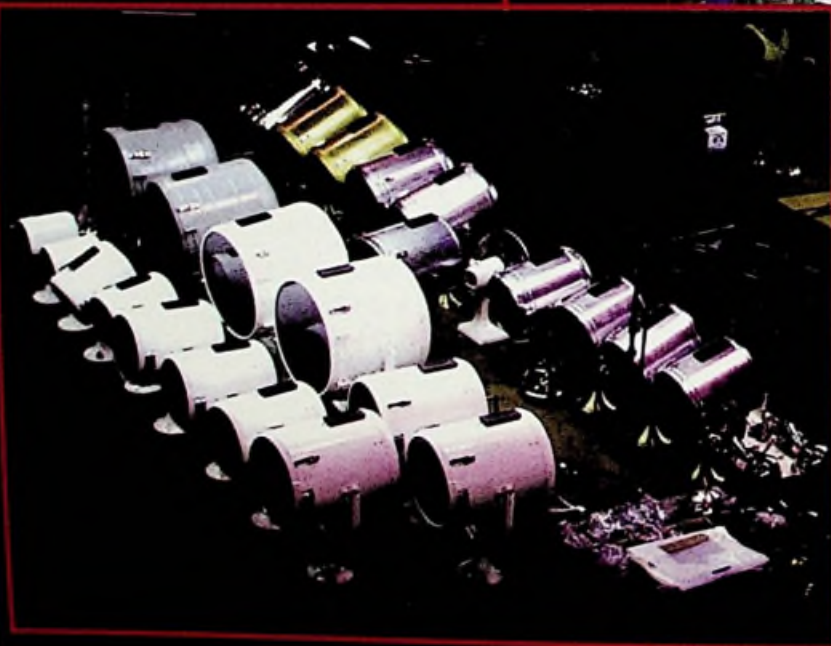

**Bottom Right:**  
**State-of-the-Art**  
**Sand Cast Foundry**





# OUR MODERN SELF-CONTAINED FACILITY



**Top Left:**  
**Plastic Injection Molding  
Department**

**Below:**  
**Battery Switch Assembly  
Department**



**Right:**  
**Computerized  
CNC Machining  
Center**

**Below:**  
**Automatic  
Drilling Centers**

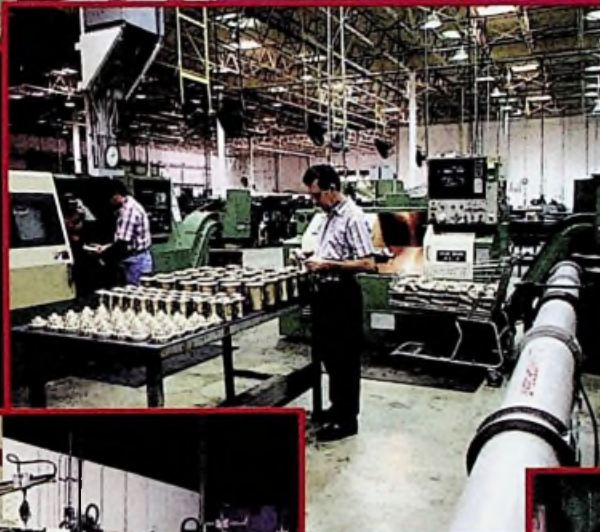

**Below:**  
**Mechanical Power Press  
Department**



**Left:**  
**Ultrasonic Bonding of  
Navigation Light Lenses**



# REGIONAL SALES REPRESENTATIVES

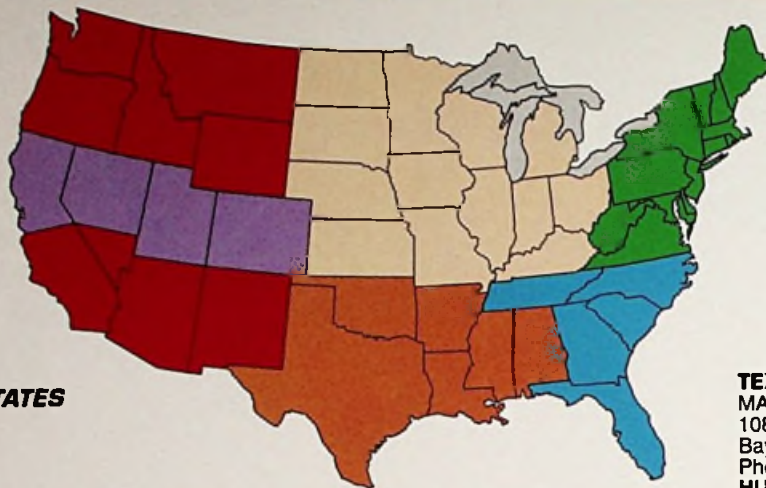

**UNITED STATES**



**EUROPE**

## NORTHEAST

**NEW HAMPSHIRE, VERMONT, CONNECTICUT, MAINE, NO. MASS.**  
Carswell, Gallagher, Williams Associates  
354 Country Way/P.O. Box 414  
Scituate, MA 02066  
Phone 617-545-3790/Fax 617-545-0359  
**CHARLES W. O'CONNOR**

**SO. MASS. RHODE ISLAND, LONG ISLAND**  
Carswell, Gallagher, Williams Associates  
137 Brandt Island Road  
Mattapoisett, MA 02739  
Phone 508-758-2980/Fax 508-758-9705  
**WAYNE OLIVIERA**

**NEW JERSEY, DELAWARE, MARYLAND, E. PENNSYLVANIA**  
Carswell, Gallagher, Williams Associates  
3 Leavitt Lane, Princeton, NJ 08540  
Phone 609-924-5352/Fax 609-269-8125  
**JAMES GALLAGHER**

**MARYLAND, VIRGINIA**  
Carswell, Gallagher, Williams Associates  
1070 Ulmstead Circle, Arnold, MD 21012  
Phone 410-757-9630/Fax 410-757-4365  
**KEVIN WILLIAMS**

**N.Y. STATE, W. PENN., CENTRAL & E. CANADA**  
Ed Sheldon & Associates, Inc.  
12 Cranswick Lane, Rochester, NY 14618  
Phone 716-381-6845/Fax 716-385-6928  
**CHARLES KUIMJIAN**

## SOUTHEAST

**NORTH & SOUTH CAROLINA**  
Henry S. Gartner & Associates, Inc.  
2419 Tram Road, New Bern, NC 28560  
Phone 919-633-1210/Fax 919-633-1692  
**KEN WILLIAMS**

**GEORGIA, TENNESSEE**  
Henry S. Gartner & Associates, Inc.  
Mac-Hugh & Associates  
9411 Raven Hollow Rd, Brentwood, TN 37027  
Phone 615-370-4132/Fax 615-373-3867  
**ROBERT TAYLOR**

**EASTERN & CENTRAL FLORIDA**  
Henry S. Gartner & Associates, Inc.  
4305 Steed Terrace, Winter Park, FL 32792  
Phone 407-677-6414/Fax 407-677-7185  
**TRIPP HAMMACK**

**SOUTHERN FLORIDA**  
Henry S. Gartner & Associates, Inc.  
2470 N.E. 22 Street/ P.O. Box 50227  
Lighthouse Point, FL 33064  
Phone 305-781-4303/Fax 305-781-4412  
**JACK BARNES & JAY BARNES**

**WESTERN & CENTRAL FLORIDA**  
Henry S. Gartner & Associates, Inc.  
8300 Ulmerton Road/Suite A18F  
Largo, FL 34641  
Phone 813-535-2833/Fax 813-531-8219  
**BRUCE WEBER**

## MIDWEST

**MISSOURI, IOWA, NO. & SO. DAKOTA, NEBRASKA, KANSAS**  
Midwestern Sales Co., Inc.  
9849 Briar Drive, Overland Park, KS 66207  
Phone 913-649-1270/Fax 913-649-2707  
**DENNIS WILLS & BILL LANNING**

**NO. ILLINOIS, NO. INDIANA, W. MICHIGAN**  
Inland Marketing Associates, Inc.  
601 Franklin Square/P.O. Box 680  
Michigan City, IN 46360  
Phone 219-879-2707/Fax 219-879-5224  
**EARL HENDERSON**

**NO. ILLINOIS, NO. INDIANA, MINNESOTA, WISCONSIN**  
Inland Marketing Associates, Inc.  
730 N. Waukegan Road/P.O. Box 325  
Deerfield, IL 60015  
Phone 708-945-0545/Fax 708-945-0567  
**WM. D. GREENE**

**SO. ILLINOIS, SO. INDIANA, KENTUCKY, W. MICHIGAN**  
Inland Marketing Associates, Inc.  
1071 Highland Ct./P.O. Box 414  
Plymouth, IN 46563  
Phone 219-936-6972/Fax 219-936-8248  
**ED KUYKENDALL**

**E. MICHIGAN, OHIO**  
Inland Marketing Associates, Inc.  
500 S. Washington/Suite 11  
Royal Oak, MI 48067  
Phone 313-541-4404/Fax 313-541-4405  
**R. WILLIAM BURT**

## SOUTH CENTRAL

**LOUISIANA, ALABAMA, MISSISSIPPI, SO. EAST ARKANSAS,**  
MAC-HUGH & Associates, Inc.  
5540 Pepsi Street, Harahan, LA 70123  
Phone 504-734-9411/Fax 504-734-5144  
**KYLE McHUGH, BUZZ HUMPHREY, DAVID HILDRETH,**

**TEXAS, OKLAHOMA, ARKANSAS**  
MAC-HUGH & Associates, Inc.  
10830 Tri-Cities Beach Road  
Bay Town, TX 77520  
Phone 713-383-2235  
**HUGH W. MULHOLLAND**

## WEST CENTRAL

**NO. CALIFORNIA, NO. NEVADA, UTAH, COLORADO, HAWAII**  
Dugan & Associates, Inc.  
3368 McGraw Road, Lafayette, CA 94549  
Phone 510-284-4855/Fax 510-284-4856  
**WAYNE R. MOOERS**

## WEST

**SO. CALIFORNIA, SO. NEVADA, ARIZONA, NEW MEXICO**  
Merifield Co., Inc.  
P.O. Box 3160, Tustin, CA 92666  
Phone 714-639-9462/Fax 714-639-9382  
**DAN A. NABER**

**W. WASHINGTON, ALBERTA, BRITISH COLUMBIA, S.E. ALASKA**  
Merifield Co., Inc.  
927 N.W. 50th Street/P.O. Box 70626  
Seattle, WA 98107  
Phone 206-789-1800/Fax 206-783-7669  
**TOM HARGER, IVAN CROSS, JON EDWARDS**

**OREGON, W. IDAHO**  
Merifield Co., Inc.  
10325 S.W. 57th Place, Portland, OR 97219  
Phone 503-244-6451/Fax 503-245-7224  
**JERRY LANAHAN**

**E. IDAHO, MONTANA, WYOMING E. WASHINGTON**  
Merifield Co., Inc.  
E. 3202 Diane Court, Spokane, WA 99223  
Phone 509-448-0848/Fax 509-448-2939  
**TERRY HECKEL**

**CENTRAL & NO. ALASKA**  
Merifield Co., Inc.  
750 W. Diamond/Suite 201  
Anchorage, AK 99515  
Phone 907-344-3825/Fax 907-349-7612  
**BRUCE FRIEND**

## EUROPE

**KEITH W. HEWITT**  
Penvic Marine Limited  
32 Copperfields - Totton  
Southampton Hampshire SO42FL  
England  
Phone (44) 703 870341/Fax (44) 703 663156

For information on other Foreign Regions  
Contact: Jose Martinez at Perko, Inc.



# DISPLAY PACKAGING PROGRAM

SINCE THE PUBLICATION OF OUR LAST CATALOG, WE ARE CONTINUING TO INCREASE THE NUMBER OF PRODUCTS AVAILABLE IN "DISPLAY PACK" FORM. THESE ATTRACTIVE PACKAGES CONTINUE TO MAKE PERKO PRODUCTS EASIER TO SELL . . . AND EASIER FOR THE CUSTOMER TO BUY.

OUR COMMITMENT TO BETTER DEALER/DISTRIBUTOR SALES AND PROFITS IS BACKED BY OUR CONTINUING PROGRAM OF SERVICE AND SUPPORT. IT'S A PERKO PLUS!

AS YOU LOOK THROUGH THIS CATALOG YOU WILL FIND SYMBOLS, SIMILAR TO THE ONE BELOW, THAT REPRESENT THE "DISPLAY PACKED" ITEMS. THE FOUR "DISPLAY PACK" STYLES ARE ILLUSTRATED BELOW.



**BAG**



**BLISTER PACK**



**BUBBLE PACK**



**SKIN PACK**



## NAVIGATION LIGHT APPROVALS

### U.S.A. AND INTERNATIONAL APPROVALS OF NAVIGATION LIGHTS FOR VESSELS UNDER 20 METERS (65.6 FT.) IN LENGTH.

The U.S.C.G. regulates and enforces the configuration and carriage of lights on recreational boats, but industry standards regulate the design, manufacture, and certification of the lights. The only means of certification recognized in the United States is through the NMMA certification procedure. Our Navigation lights are certified under the NMMA Certification Procedure. The marking "A-16" on the light fixture indicates this certification. Therefore, the proper installation of a current model of PERKO navigation lights will assure the meeting of the U.S. regulation in effect at the time.

Certain models and configurations of PERKO navigation lights have been approved for use in over 50 countries by their respective governing authorities. Where required, appropriate approval markings are on these navigation lights. However, due to frequent changes and additions to the approval list, contact PERKO for the latest information concerning model selection for a particular purpose and/or use in a particular country.

All PERKO navigation lights are approved under the regulations developed by the International Maritime Organization ('72 COLREGS) and are approved for use in international waters. The countries accepting the '72 COLREG regulations for navigation lights used in their territorial waters include the countries of South America, Africa, the Middle East and Far East (except Japan where only lights made in Japan are accepted), Australia, New Zealand, Canada, Spain and Greece (pending government stability). Several European countries have additional regulations and require separate approvals for navigation lights used in their territorial waters in accordance with those regulations. The European countries where specific PERKO navigation lights are approved or have approval pending for use in their territorial waters and those specific lights are shown below.

The following chart summarizes approvals at time of publication.

P = Approved for Power Driven Vessels and Sailing Vessels Operating Under Auxiliary Power.

S = Approved for Sailing Vessels Operating Under Sail Alone.

AP = Approval Pending.

#### Bi-Color Lights

#### Side Lights

#### Tri-Color

Country	Vessel Size In Meters	Bi-Color Lights										Side Lights					Tri-Color	
		120	170	200B	200T	252	970	1161,	1605	1603	120	170	200B	253	955	963	1601	200TB
Denmark	Under 7 (23.0 ft.)	P&S		P&S	P&S							P&S						S
	Under 12 (39.4 ft.)	P&S		P&S	P&S							P&S						S
Finland	Under 7 (23.0 ft.)	P&S		P&S	P&S				P&S			P&S				P&S	P&S	
	Under 12 (39.4 ft.)	P&S		P&S	P&S							P&S						
France	Under 12 (39.4 ft.)†	P&S		P&S								P&S						P&S
	Under 20 (65.3 ft.)*			P&S		AP			AP			P&S	AP					P&S
Italy♥	Under 12 (39.4 ft.)	P&S	AP	P&S	P&S	AP	P	P	AP			P&S	P&S	P&S	AP	P&S	P	S
	Under 20 (65.3 ft.)		P&S	P&S	P&S	AP			P&S			P&S	AP					S
Norway	Under 7 (23.0 ft.)	P&S	P&S	P&S	P&S	AP						P&S						
	Under 12 (39.4 ft.)			P&S	P&S													
Sweden	Under 7 (23.0 ft.)	AP		AP	AP						AP							
	Under 12 (39.4 ft.)			AP	AP													
United Kingdom	Under 12 (39.4 ft.)	P&S		P&S	P&S	AP		P	AP	P		P&S		AP			P	S
	Under 20 (65.3 ft.)			P&S	P&S	AP			AP					AP				S

#### Masthead Lights

#### Combination Masthead & White All Round Lights

Country	Vessel Size In Meters	Masthead Lights										Combination Masthead & White All Round Lights						
		120	120	170	200B	200T	964	1178	1331	200	1123	1123	1125	1181	1183	1184	1196	1197
Denmark	Under 7 (23.0 ft.)	P																
	Under 12 (39.4 ft.)	P																
Finland	Under 7 (23.0 ft.)	P	P		P				P									
	Under 12 (39.4 ft.)	P	P		P				P									
France	Under 12 (39.4 ft.)†	P			P													
	Under 20 (65.3 ft.)				P													
Italy♥	Under 12 (39.4 ft.)	P	P	P	P	P	P	P	P	P&S	P&S	P&S	P&S	P&S	P&S	P&S	P&S	P&S
	Under 20 (65.3 ft.)			P	P		P	P	P	P&S	P&S	P&S	P&S	P&S	P&S	P&S	P&S	P&S
Norway	Under 7 (23.0 ft.)	P			P													
	Under 12 (39.4 ft.)				P													
Sweden	Under 7 (23.0 ft.)	AP			AP													
	Under 12 (39.4 ft.)	AP			AP													
United Kingdom	Under 12 (39.4 ft.)	P	P		P				P									
	Under 20 (65.3 ft.)				P				P									

#### Stern Lights

#### White All Round Lights

Country	Vessel Size In Meters	Stern Lights										White All Round Lights						
		120	170	200B	200T	939	945	946	965	120	200B	200H	1301	1411	1134	1430	1630	1631
Denmark	Under 7 (23.0 ft.)	P&S		P&S														
	Under 12 (39.4 ft.)	P&S		P&S						P&S☆	P&S☆							
Finland	Under 7 (23.0 ft.)	P&S		P&S						P&S☆	P&S☆							
	Under 12 (39.4 ft.)	P&S		P&S						P&S	P&S							
France	Under 12 (39.4 ft.)†	P&S		P&S						P&S	P&S☆	P&S☆	P&S	P&S	P&S	P&S	P&S	P&S
	Under 20 (65.3 ft.)			P&S						P&S	P&S☆	P&S☆	P&S	P&S	P&S	P&S	P&S	P&S
Italy♥	Under 12 (39.4 ft.)	P&S	P&S	P&S	P&S	P&S	P&S	P		P&S☆	P&S☆	P&S☆	P&S	P&S	P&S	P&S	P&S	P&S
	Under 20 (65.3 ft.)		P&S	P&S	P&S	P&S	P&S			P&S☆	P&S☆	P&S☆	P&S	P&S	P&S	P&S	P&S	P&S
Norway	Under 7 (23.0 ft.)	P&S		P&S						P&S☆	P&S☆							
	Under 12 (39.4 ft.)			P&S						P&S☆	P&S☆							
Sweden	Under 7 (23.0 ft.)	AP		AP														
	Under 12 (39.4 ft.)			AP														
United Kingdom	Under 12 (39.4 ft.)	P&S		P&S						P&S	P&S☆	P&S☆	P&S	P&S	P&S	P&S	P&S	P&S
	Under 20 (65.3 ft.)			P&S						P&S	P&S☆	P&S☆	P&S	P&S	P&S	P&S	P&S	P&S

♦ Approved for use on Pleasure and Commercial Craft.

♥ Approved for Use on Pleasure Craft Only.

♦ Approved for Use on All Vessels Under 50 Meters (164.0 ft.) In Length.

♦ Approved as White All-Round Light Only for Vessels Operating Under Sail Alone.

☆ Approval Includes Red & Green All-Round Lights.

† France Allows the Use of All Lights on Vessels under 7 Meters (23.0 ft.) Regardless of Approval Status.



## BI-COLOR LIGHTS

FOR USE ON VESSELS UNDER 12 METERS (39.4 FT.) IN LENGTH AS SPECIFIED BELOW.

**1 MILE VISIBILITY**

**RED AND GREEN LENSES, COMPLETE WITH 12 VOLT BULB.**

PATENT No. 4,500,947

**FIG. 1310 - CHROME PLATED ZINC WITH BLACK PLASTIC BASE**

**FIG. 1161 - CHROME PLATED BRONZE WITH BLACK PLASTIC BASE**

**FIG. 1410 - CHROME PLATED ZINC WITH BLACK PLASTIC BASE AND INSERT**

For Use on Power Driven Vessels Under 12 Meters (39.4 ft.) in Length.



**chromalex®**

### ORDERING INFORMATION



**FIG. 1310 & 1161**



**FIG. 1410**

Dimensions Base Inches	Vertical Height Inches	Display Pkg. - 5 Cards 1 Pc. per Card	OEM Bulk Pkg. 50 Pcs.	Screw Size	Weight Ounces
4 x 3-1/8	1	1310 DP CHR	1310 000 CHR	8	5-1/2
4 x 3-1/8	1	1161 DP CHR	1161 000 CHR	8	5-1/2
4 x 3-1/8	1	1410 DP CHR	1410 000 CHR	8	5-1/2

Spare Bulbs (2 per card), Cat. No. 71 DP CLR.

Spare Lens Set (1-Red & 1-Green), Cat. No. 283 DPA LNS.

Spare Base with Socket Assembly, Cat. No. 136.

**FIG. 1218 - CHROME PLATED ZINC WITH FLAG STAFF SOCKET**

For Use on Power Driven Vessels Under 12 Meters (39.4 ft.) in Length.



### ORDERING INFORMATION

Dimensions Base Inches	Vertical Height Inches	I.D. Socket Inches	Display Pkg. - 5 Cards 1 Pc. per Card	Screw Size	Weight Ounces
6-3/4 x 3-7/8	1-5/8	3/4	1218 DP CHR	8	12

Spare Bulbs (2 per card), Cat. No. 71 DP CLR.  
Spare Socket Assembly, Cat. No. 1218 DP 99A.

Spare Lens Set (1-Red & 1-Green), Cat. No. 259 DPA LNS.



**FIG. 1218**

**FIG. 904 - CHROME PLATED BRASS TOP WITH BLACK PLASTIC BASE**

For Use on Sail or Power Driven Vessels Under

12 Meters (39.4 ft.) in Length.



**chromalex®**

### ORDERING INFORMATION

Length Inches	Width Inches	Vertical Height Inches	Display Pkg. - 5 Cards 1 Pc. per Card	OEM Bulk Pkg. 10 Pcs.	Screw Size	Weight Ounces
4-1/4	2-1/8	7/8	904 DP CHR	904 000 CHR	4	3-1/2

Spare Bulbs (2 per card), Cat. No. 71 DP CLR.  
Spare Base with Socket Assembly, Cat. No. 107.

Spare Lens Set (1-Red & 1-Green), Cat. No. 296 DP LNS.



**FIG. 904**

**NOTE: TO USE THE LIGHTS ON THIS PAGE IN A 24 VOLT SYSTEM, ORDER REPLACEMENT BULBS (2 PER CARD) CAT. NO. 72 DP1 CLR.**



## BI-COLOR LIGHTS

FOR USE ON SAIL OR POWER DRIVEN VESSELS UNDER 12 METERS (39.4 FT.) IN LENGTH.  
PATENT NO. 4,500,947

**1 MILE VISIBILITY**  
**RED AND GREEN LENSES, COMPLETE WITH 12 VOLT BULB.**



### FIG. 972 - CHROME PLATED BRASS TOP WITH BLACK PLASTIC BASE HORIZONTAL MOUNT



Fig. 972

**chromalex®**

#### ORDERING INFORMATION

O.D. Length Inches	Vertical Height Inches	Display Pkg. - 5 Cards 1 Pc. per Card	OEM Bulk Pkg. 25 Pcs.	Screw Size	Weight Ounces
2-3/8	7/8	972 DP CHR	972 000 CHR	4	3

Spare Bulbs (2 per card), Cat. No. 71 DP CLR.  
Spare Base with Socket Assembly, Cat. No. 135.

Spare Lens Set (1 - Red & 1-Green), Cat. No. 296 DP LNS.



### FIGS. 120 & 170 - CHROME PLATED BRASS TOPS WITH BLACK PLASTIC BASES BLACK OR WHITE PLASTIC TOPS WITH BLACK PLASTIC BASES VERTICAL MOUNT



#### ORDERING INFORMATION



Fig. 120 & 170 MB

Finish	Height Overall Inches	Projection Overall Inches	Width Inches	Display Pkg. 5 Cards 1 Pc. per Card	Std Pkg. - 1 Pc. OEM Bulk Pkg.-10 Pcs.	Screw Size	Weight Ounces
Chrome	3-5/8	2-1/2	4-1/8	120 MB DP1	120 MB 12V	10	5
Black	3-5/8	2-1/2	4-1/8	120 BB DP1	120 BB 12V	10	5
White	3-5/8	2-1/2	4-1/8	120 WB DP1	120 WB 12V	10	5
Chrome*	3-5/8	2-1/2	4-1/8	170 MB DP1	170 MB 12V	10	5
Black*	3-5/8	2-1/2	4-1/8	170 BB DP1	170 BB 12V	10	5
White*	3-5/8	2-1/2	4-1/8	170 WB DP1	170 WB 12V	10	5

Note: See Pages 22 through 24 for Complete Series, 24 Volt Options & Spare Parts Ordering Information.

\* New Items



### FIG. 1605 - CHROME PLATED ZINC OR BLACK PLASTIC TOPS WITH BLACK PLASTIC BASES

### FIG. 1606 - CHROME PLATED ZINC OR BLACK PLASTIC TOPS WITH WHITE PLASTIC BASES HORIZONTAL MOUNT



Fig. 1605

**chromalex®**

#### ORDERING INFORMATION



Fig. 1606

Finish	Vertical Height Inches	Height Overall Inches	Dimensions Base Inches	Display Pkg. - 5 Cards 1 Pc. per Card	OEM Bulk Pkg. 50 Pcs.	Screw Size	Weight Ounces
Chrome	5/8	1-1/2	2-1/2 x 2	1605 DP CHR	1605 000 CHR	8	3
Black	5/8	1-1/2	2-1/2 x 2	1605 DP BLK	1605 000 BLK	8	3
Chrome	5/8	1-1/2	2-1/2 x 2	1606 DP CHR	1606 000 CHR	8	3
White	5/8	1-1/2	2-1/2 x 2	1606 DP WHT	1606 000 WHT	8	3

Spare Bulbs (2 per card), Cat. No. 71 DP CLR.

Spare Base with Socket Assembly, Cat. No. 157 000 BLK.

Spare Lens (Red & Green), Cat. No. 289 DP LNS.

Spare Base with Socket Assembly, Cat. No. 157 000 WHT.

NOTE: TO USE THE LIGHTS ON THIS PAGE (EXCEPT FIGS. 120 & 170) IN A 24 VOLT SYSTEM, ORDER REPLACEMENT BULBS (2 PER CARD) CAT. NO. 72 DP1 CLR.



## BI-COLOR LIGHTS

FOR USE ON SAIL OR POWER DRIVEN VESSELS AS SPECIFIED BELOW.

PATENT No. 4,500,947

**RED AND GREEN LENSES, COMPLETE WITH BULBS AS SPECIFIED BELOW.**

### FIG. 252 - BI-COLOR LIGHT

For Use on Power Driven Vessels only under 20 Meters (65.6 ft.) in Length (12 or 24 Volt.)



**2 MILE VISIBILITY.**

**WHITE OR BLACK PLASTIC WITH ULTRASONICALLY WELDED LENSES GASKETED TO THE BASE.**



#### ORDERING INFORMATION

Finish	Length Inches	Width Inches	Height Inches	Display Pkg. 5 Cards 1 Pc. per Card	OEM Bulk Pkg. 25 Pcs.	Screw Size	Weight Ounces
Black-12V	3-1/2	2-1/4	1-5/8	252 BB DP1	252 BB 12V	8	3
Black-24V	3-1/2	2-1/4	1-5/8	252 BB DP2	252 BB 24V	8	3
White-12V	3-1/2	2-1/4	1-5/8	252 WB DP1	252 WB 12V	8	3
White-24V	3-1/2	2-1/4	1-5/8	252 WB DP2	252 WB 24V	8	3



**BLACK FIG. 252**



**WHITE**

Spare Bulbs (2 per card), Cat. No. 71 DP CLR.

Spare Lens (1-Red/Green), Cat. No. 247 DP LNS.

Spare Black Base with Socket Assembly, Cat. No. 114 000 BLK.

Spare White Base with Socket Assembly, Cat. No. 114 000 WHT.

### FIG. 1603 - BLACK PLASTIC

**1 MILE VISIBILITY**

For Use on Sail or Power Driven Vessels under 12 Meters (39.4 ft.) in Length. Complete with 12 Volt Bulb.



#### ORDERING INFORMATION

Finish	Vertical Height Inches	Height Overall Inches	Dimensions		Display Pkg. - 5 Cards 1 Pc. per Card	OEM Bulk Pkg. 50 Pcs.	Screw Size	Weight Ounces
			Base Inches	Display Pkg. - 5 Cards 1 Pc. per Card				
Black	1-1/8	1-7/8	1-1/8 x 3	1603 DP BLK	1603 000 BLK	8	2-1/4	



**FIG. 1603**

Spare Bulbs (2 per card), Cat. No. 71 DP CLR.

Spare Lens Set (1-Red & 1-Green), Cat. No. 283 DPA LNS.

Spare Base with Socket Assembly, Cat. No. 139 000 BLK.

### FIG. 1201 - TRI-COLOR

\*For Use on Vessels Under Sail Alone Under 12 Meters (39.4 ft.) in Length.

**BLACK PLASTIC AND CHROME PLATED ZINC TOP WITH CHROME PLATED ZINC BASE**

**RED AND GREEN BI-COLOR - 1 MILE VISIBILITY**

**WHITE (STERN) - 2 MILE VISIBILITY**

Complete with 12 Volt Bulb.

**chromalex®**

#### ORDERING INFORMATION

Vertical Height Inches	Dimensions		Display Pkg. - 5 Cards 1 Pc. per Card	OEM Bulk Pkg. 50 Pcs.	Screw Size	Weight Ounces
	Base Inches	Display Pkg. - 5 Cards 1 Pc. per Card				
3-1/4	1 x 2-5/8	1201 DP BLK	1201 000 BLK	8	7	



**FIG. 1201**

Spare Bulbs (2 per card), Cat. No. 71 DP CLR.

Spare Bi-Color Lens Set (1-Red & 1-Green), Cat. No. 268 DP LNS.

Spare White Lenses (2 per card), Cat. No. 278 DP WHT.

Spare Top Cap with Screw, Cat. No. 1158 DP BLK.

**NOTE: TO USE THE LIGHTS ON THIS PAGE IN A 24 VOLT SYSTEM, ORDER REPLACEMENT BULBS (2 PER CARD) CAT. No. 72 DP1 CLR.**



## REMOVABLE BI-COLOR LIGHTS

FOR USE ON SAIL OR POWER DRIVEN VESSELS UNDER 12 METERS (39.4 FT.) IN LENGTH.

PATENT No. 4,500,947

**1 MILE VISIBILITY - RED & GREEN LENSES, COMPLETE WITH 12 VOLT BULB.  
3/4 INCH DIAMETER ANODIZED ALUMINUM TUBE - WATERPROOF COVER FOR BASES.**



**FIG. 1211 - BLACK PLASTIC AND CHROME PLATED ZINC TOP WITH UTILITY LIGHT, CHROME PLATED BRASS AND BLACK PLASTIC BASE**

**FIG. 1212 - BLACK PLASTIC AND CHROME PLATED ZINC TOP WITH UTILITY LIGHT, CHROME PLATED ZINC BASE**

**FIG. 1296 - BLACK PLASTIC AND CHROME PLATED ZINC TOP WITH UTILITY LIGHT, CHROME PLATED BRASS AND BLACK PLASTIC BASE WITH WATER RESISTANT SLIDE COVER**



Fig. 1211



Fig. 1212



Fig. 1296



Deck Illuminating Utility Light in the Rear Section of the Top, Controlled by a Switch Located on the Top Cover.

**chromalex®**

### ORDERING INFORMATION

Vertical Height Inches	Dimensions Base Inches	Display Pkg. - 5 Cards 1 Pc. per Card	OEM Bulk Pkg. 50 Pcs.	Screw Size	Weight Ounces
10	2-1/4 O.D.	1211 DP CHR	1211 000 CHR	8	8
10-1/4	3-3/4 x 1-3/4	1212 DP CHR	1212 000 CHR	8	8
10	3-12 x 1-1/2	1296 DP CHR	1296 000 CHR	8	8

Spare Bulbs for Bi-Color Section (2 per card), Cat. No. 71 DP CLR.  
Spare Bulb for Utility Light, Cat. No. 64 000 CLR.  
Spare Lens Set (1-Red & 1-Green), Cat. No. 268 DP LNS.  
Spare Mounting Base for Fig. No. 1211, Cat. No. 1045 300 DP.  
Spare Mounting Base for Fig. No. 1212, Cat. No. 1060 380 DP.  
Spare Mounting Base for Fig. No. 1296, Cat. No. 1047 380 DP.



**FIG. 1612 - BLACK PLASTIC TOP WITH CHROME PLATED BRASS AND BLACK PLASTIC BASE**

**FIG. 970 - CHROME PLATED BRASS TOP WITH CHROME PLATED BRASS AND BLACK PLASTIC BASE**

**chromalex®**

### ORDERING INFORMATION

Vertical Height Inches	O.D. Base Inches	Display Pkg. - 5 Cards 1 Pc. per Card	OEM Bulk Pkg. 50 Pcs.	Screw Size	Weight Ounces
9-3/4	2-1/4	1612 DP BLK	1612 000 BLK	8	7
9-3/4	2-1/4	970 DP CHR	970 000 CHR	8	8

Spare Bulbs (2 per card), Cat. No. 71 DP CLR.  
Spare Lens Set For Fig. 1612 (1-Red & 1-Green), Cat. No. 283 DP LNS.  
Spare Mounting Base, Cat. No. 1045 P00 DP.  
Spare Lens Set for Fig. 970 (1-Red & 1-Green), Cat. No. 296 DP LNS.



Fig. 1612



Fig. 970



**NOTE: To Use Figs. 970 or 1612 ABOVE IN A 24 VOLT SYSTEM, ORDER REPLACEMENT BULBS (2 PER CARD) CAT. No. 72 DP1 CLR.**



## SIDE LIGHTS

FOR USE ON SAIL OR POWER DRIVEN VESSELS UNDER 12 METERS (39.4 FT.) IN LENGTH.

1 MILE VISIBILITY - RED AND GREEN LENSES, COMPLETE WITH 12 VOLT BULBS.

### FIG. 915 - CHROME PLATED BRASS TOPS WITH BLACK PLASTIC BASES



#### HORIZONTAL SURFACE MOUNT

**chromalex**

#### ORDERING INFORMATION

Length Inches	Vertical Width Inches	Height Inches	Display Pkg. - 5 Cards 1 Pair per Card	OEM Bulk Pkg. 10 Pair	Screw Size	Weight Per Pair Ounces
4-1/4	2-3/8	7/8	915 DP CHR	915 000 CHR	4	7

Green Side Light Only, Cat. No. 915 G00 CHR.  
Red Side Light Only, Cat. No. 915 R00 CHR.  
Spare Bulbs (2 per card), Cat. No. 71 DP CLR.

Spare Lens Set (1-Red & 1-Green), Cat. No. 281 DPA LNS.  
Spare Base with Socket Assembly, Cat. No. 107.



**Fig. 915**

### FIG. 955 - CHROME PLATED BRASS TOPS WITH BLACK PLASTIC BASES



#### VERTICAL SURFACE MOUNT

**chromalex**

#### ORDERING INFORMATION

Length Inches	Vertical Width Inches	Height Inches	Display Pkg. - 5 Cards 1 Pair per Card	OEM Bulk Pkg. 10 Pair	Screw Size	Weight Per Pair Ounces
4-1/4	2-3/8	1-5/8	955 DP CHR	955 000 CHR	4	7

Green Side Light Only, Cat. No. 955 G00 CHR.  
Red Side Light Only, Cat. No. 955 R00 CHR.  
Spare Bulbs (2 per card), Cat. No. 71 DP CLR.

Spare Lens Set (1-Red & 1-Green), Cat. No. 260 DP LNS.  
Spare Base with Socket Assembly, Cat. No. 955 000 99A.



**Fig. 955**

### FIG. 963 - CHROME PLATED BRASS TOPS WITH BLACK PLASTIC BASES



#### HORIZONTAL SURFACE MOUNT

**chromalex**

#### ORDERING INFORMATION

O.D. Base Inches	Vertical Height Inches	Display Pkg. - 5 Cards 1 Pair per Card	OEM Bulk Pkg. 10 Pair	Screw Size	Weight Per Pair Ounces
2-3/8	7/8	963 DP CHR	963 000 CHR	4	6

Green Side Light Only, Cat. No. 963 G00 CHR.  
Red Side Light Only, Cat. No. 963 R00 CHR.  
Spare Bulbs (2 per card), Cat. No. 71 DP CLR.

Spare Lens Set (1-Red & 1-Green), Cat. No. 281 DPA LNS.  
Spare Base with Socket Assembly, Cat. No. 135.



**Fig. 963**



**NOTE: TO USE LIGHTS ON THIS PAGE IN A 24 VOLT SYSTEM, ORDER REPLACEMENT BULBS (2 PER CARD) CAT. NO. 72 DP1 CLR.**



## SIDE LIGHTS

FOR USE ON SAIL OR POWER DRIVEN VESSELS AS SPECIFIED BELOW.  
RED AND GREEN LENSES, COMPLETE WITH 12 VOLT OR 24 VOLT BULBS.

**FIGS. 120 AND 170 - CHROME PLATED BRASS TOPS WITH BLACK PLASTIC BASES,  
BLACK OR WHITE PLASTIC TOPS WITH BLACK PLASTIC BASES.**

### VERTICAL MOUNT



Height Overall Inches	Projection Overall Inches	Width Inches	Screw Size	Weight Ounces
3-5/8	2-1/2	4-1/8	10	5



**FIGS. 120 MSD &  
170 MSD**

**FIG. 120 - FOR USE ON  
SAIL OR POWER DRIVEN VESSELS UNDER  
12 METERS (39.4 FT.) IN LENGTH (12 VOLTS).  
1 MILE VISIBILITY**



**FIGS. 120 MP &  
170 MP**

### ORDERING INFORMATION - 12 VOLT



**FIGS. 120 BSD &  
170 BSD**

Description	Display Pkg. 5 - Cards 1 Pc. per Card	Std Pkg.- 1 Pc. OEM Pkg. - 10 Pcs.
<b>Chrome</b>		
Red Side Light	120 MP DP1	120 MP 12V
Green Side Light	120 MSD DP1	120 MSD 12V
<b>Black Plastic</b>		
Red Side Light	120 BP DP1	120 BP 12V
Green Side Light	120 BSD DP1	120 BSD 12V
<b>White Plastic</b>		
Red Side Light	120 WP DP1	120 WP 12V
Green Side Light	120 WSD DP1	120 WSD 12V



**FIGS. 120 BP &  
170 BP**



**FIGS. 120 WSD &  
170 WSD**



**FIGS. 120 WP &  
170 WP**

**FIG. 170 - FOR USE ON SAIL OR POWER DRIVEN VESSELS UNDER  
20 METERS (65.6 FT.) IN LENGTH (12 OR 24 VOLTS).  
2 MILE VISIBILITY**

### ORDERING INFORMATION - 12 VOLT

Description	Display Pkg. 5 - Cards 1 Pc. per Card	Std Pkg.- 1 Pc. OEM Pkg. - 10 Pcs.
<b>Chrome</b>		
Red Side Light	170 MP DP1	170 MP 12V
Green Side Light	170 MSD DP1	170 MSD 12V
<b>Black Plastic</b>		
Red Side Light	170 BP DP1	170 BP 12V
Green Side Light	170 BSD DP1	170 BSD 12V
<b>White Plastic</b>		
Red Side Light	170 WP DP1	170 WP 12V
Green Side Light	170 WSD DP1	170 WSD 12V

### ORDERING INFORMATION - 24 VOLT

Description	Display Pkg. 5 - Cards 1 Pc. per Card	Std Pkg.- 1 Pc. OEM Pkg. - 10 Pcs.
<b>Chrome</b>		
Red Side Light	170 MP DP2	170 MP 24V
Green Side Light	170 MSD DP2	170 MSD 24V
<b>Black Plastic</b>		
Red Side Light	170 BP DP2	170 BP 24V
Green Side Light	170 BSD DP2	170 BSD 24V
<b>White Plastic</b>		
Red Side Light	170 WP DP2	170 WP 24V
Green Side Light	170 WSD DP2	170 WSD 24V

Note: See Pages 22 through 24 for Complete Series, 24 Volt Options & Spare Parts Ordering Information.



## SIDE LIGHTS

**FOR USE ON SAIL\* OR POWER DRIVEN VESSELS AS SPECIFIED BELOW.  
RED AND GREEN LENSES, COMPLETE WITH 12 VOLT BULBS.**

**FIG. 253 - HORIZONTAL MOUNT SIDE LIGHT  
FIG. 254 - VERTICAL MOUNT SIDE LIGHT**

For Use on Power Driven Vessels only under 20 Meters (65.6 ft.) in Length (12 or 24 Volt.)  
**2 MILE VISIBILITY.**

**WHITE OR BLACK PLASTIC WITH ULTRASONICALLY WELDED  
LENSES GASKETED TO THE BASE.**

**COMPLETE WITH 12 OR 24 VOLT BULBS**

### ORDERING INFORMATION

Fig. 253 Color	Length Inches	Width Inches	Height Inches	Display Pkg. 5 Cards	OEM Bulk Pkg.	Screw Size	Weight/Pair Ounces
				1 Pair per Card	10 Pair		
Black-12V	3-1/2	2-1/4	1-5/8	253 B DP1	253 B 12V	8	6
Black-24V	3-1/2	2-1/4	1-5/8	253 B DP2	253 B 24V	8	6
White-12V	3-1/2	2-1/4	1-5/8	253 W DP1	253 W 12V	8	6
White-24V	3-1/2	2-1/4	1-5/8	253 W DP2	253 W 24V	8	6

Fig. 254 Color	Length Inches	Width Inches	Height Inches	Display Pkg. 5 Cards	OEM Bulk Pkg.	Screw Size	Weight/Pair Ounces
				1 Pair per Card	10 Pair		
Black-12V	3-1/2	2-1/4	1-5/8	254 B DP1	254 B 12V	8	6
Black-24V	3-1/2	2-1/4	1-5/8	254 B DP2	254 B 24V	8	6
White-12V	3-1/2	2-1/4	1-5/8	254 W DP1	254 W 12V	8	6
White-24V	3-1/2	2-1/4	1-5/8	254 W DP2	254 W 24V	8	6

Fig. 253 Green Spare Lens Only, Cat. No. 273 DPG LNS.

Fig. 253 Red Spare Lens Only, Cat. No. 273 DPR LNS.

Fig. 253 Spare Base with Socket Assembly, Cat. No. 114 000 BLK/WHT.

Spare Bulbs for Fig. 253 (2 per card), Cat. No. 71 DP CLR.

Fig. 254 Green Spare Lens Only, Cat. No. 277 DPG LNS.

Fig. 254 Red Spare Lens Only, Cat. No. 277 DPR LNS.

Fig. 254 Spare Base with Socket Assembly, Cat. No. 254 BLK/WHT 99A.



**FIG. 253  
WHITE**



**FIG. 254  
BLACK**

**FIG. 1264 - CHROME PLATED ZINC WITH BLACK VINYL MOUNTING GASKET  
VERTICAL SURFACE MOUNT**

**\*For Use on Power Driven Vessels Only.  
Complete with 12 Volt Bulb.**

**1 MILE VISIBILITY**

### ORDERING INFORMATION

Length Inches	Width Inches	Projection	Display Pkg. - 5 Cards	Screw Size	Weight Per Pair Pounds
		Overall Inches			
5-1/2	3-1/8	1-3/4	1 Pair per Card	8	1

Green Side Light Only, Cat. No. 1264 G00 CHR.

Red Side Light Only, Cat. No. 1264 R00 CHR.

Spare Bulbs (2 per card), Cat. No. 71 DP CLR.

Spare Lens Set (1-Red & 1-Green), Cat. No. 1264 DPA LNS.

Spare Socket Assembly, Cat. No. 1264 DP 99A.

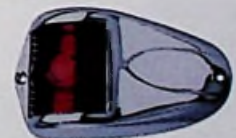

**FIG. 1264**

**FIG. 1601 - BLACK PLASTIC - NORMAL "BASE-DOWN" MOUNT**

**FIG. 1602 - BLACK PLASTIC - INVERTED "BASE-UP" MOUNT**

For Use on Sail or Power Driven Vessels under 12 Meters (39.4 ft.) In Length.  
Complete with 12 Volt Bulb.

**1 MILE VISIBILITY**

### ORDERING INFORMATION

Finish	Vertical Height	Height Overall	Dimensions Base	Display Pkg. - 5 Cards	OEM Bulk Pkg.	Screw Size	Weight Ounces
	Inches	Inches	Inches				
Black	1-1/8	1-7/8	1-1/8 x 3	1601 DP BLK	1601 000 BLK	8	2-1/4
Black	1-1/8	1-7/8	1-1/8 x 3	1602 DP BLK	1602 000 BLK	8	2-1/4

Spare Bulbs (2 per card), Cat. No. 71 DP CLR.

Spare Base with Socket Assembly, Cat. No. 139 000 BLK.

Red Spare Lens Only, Cat. No. 298 DPR LNS.

Green Spare Lens Only, Cat. No. 298 DPG LNS.



**FIG. 1601**



**FIG. 1602**



**NOTE: TO USE THE LIGHTS ON THIS PAGE IN A 24 VOLT SYSTEM, ORDER REPLACEMENT BULBS (2 PER CARD) CAT. NO. 72 DP1 CLR.**



## STERN LIGHTS

FOR USE ON SAIL OR POWER DRIVEN VESSELS UNDER 20 METERS (65.6 FT.) IN LENGTH.  
2 MILE VISIBILITY - CLEAR LENS, COMPLETE WITH 12 VOLT BULB.

### FIG. 945 - CHROME PLATED BRASS TOPS WITH BLACK PLASTIC BASE VERTICAL SURFACE MOUNT

### FIG. 965 - CHROME PLATED BRASS TOPS WITH BLACK PLASTIC BASE HORIZONTAL SURFACE MOUNT

**chromalex®**

#### ORDERING INFORMATION

Projection



**Fig. 965**

**Fig. 945**

Mount	O.D. Base Inches	Height Overall Inches	Display Pkg. - 5 Cards 1 Pc. per Card	OEM Bulk Pkg. 25 Pcs.	Screw Size	Weight Ounces
Vertical	2-3/8	1-5/8	945 DP CHR	945 000 CHR	4	3
Horizontal	2-3/8	1-5/8	965 DP CHR	965 000 CHR	4	3

Spare Bulbs For Both (2 per card), Cat. No. 71 DP CLR. Spare Lens For Fig. No. 945, Cat. No. 74 DP WHT.  
Spare Base and Socket Assembly For Fig. 945, Cat. No. 945 DP 99A. Spare Lens For Fig. No. 965, Cat. No. 281 DPA WHT.  
Spare Base and Socket Assembly For Fig. 965, Cat. No. 135.

### FIG. 940 - CHROME PLATED BRASS TOP WITH CHROME PLATED BRASS AND BLACK PLASTIC BASE HORIZONTAL SURFACE MOUNT

**chromalex®**

#### ORDERING INFORMATION



**Fig. 940**

Height Overall Inches	O.D. Overall Inches	Display Pkg. - 5 Cards 1 Pc. per Card	OEM Bulk Pkg. 50 Pcs.	Screw Size	Weight Ounces
16	2-1/4	940 DP CHR	940 000 CHR	8	8

Spare Bulbs (2 per card), Cat. No. 71 DP CLR. Spare Lens Cat. No. 281 DPA WHT.  
Spare Base Cat. No. 1045 P00 DP.

**NOTE: TO USE THE ABOVE LIGHTS IN A 24 VOLT SYSTEM, ORDER REPLACEMENT BULBS (2 PER CARD) CAT. NO. 72 DP1 CLR.**

### FIG. 939 - CHROME PLATED BRASS TOP WITH BLACK PLASTIC BASE VERTICAL FLUSH MOUNT

**chromalex®**

#### ORDERING INFORMATION



**Fig. 939**

Voltage	Dimensions Inches	Depth Inches	Display Pkg. - 5 Cards 1 Pc. per Card	OEM Bulk Pkg. 20 Pcs.	Screw Size	Weight Ounces
12 Volt	5-3/16 x 3-3/8	1-1/2	939 DP1 12V	939 001 12V	8	4
32 Volt	5-3/16 x 3-3/8	1-1/2	939 DP3 32V	-----	8	4

Spare 12 Volt Bulbs (2 per card), Cat. No. 70 DP0 CLR. Spare 12 Volt Socket Assembly, Cat. No. 939 DP1 99A.  
Spare 32 Volt Bulbs (2 per card), Cat. No. 70 DP2 CLR. Spare 32 Volt Socket Assembly, Cat. No. 939 003 99A.  
Spare Lens with Gasket, Cat. No. 284 DP CLR. Spare Mounting Flange, Cat. No. 939 000 99C.

### FIG. 946 - CHROME PLATED BRASS WITH BLACK PLASTIC BASE VERTICAL FLUSH MOUNT

**chromalex®**

#### ORDERING INFORMATION



**Fig. 946**

Voltage	O.D. Inches	Depth Inches	Display Pkg. - 5 Cards 1 Pc. per Card	OEM Bulk Pkg. 25 Pcs.	Screw Size	Weight Ounces
12 Volt	3	1	946 DP1 12V	946 001 12V	8	4
32 Volt	3	1	946 DP3 32V	-----	8	4

Spare 12 Volt Bulbs (2 per card), Cat. No. 70 DP0 CLR. Spare 12 Volt Socket Assembly, Cat. No. 946 DP1 99B.  
Spare 32 Volt Bulbs (2 per card), Cat. No. 70 DP2 CLR. Spare 32 Volt Socket Assembly, Cat. No. 946 003 99B.  
Spare Lens with Gasket, Cat. No. 946 DP 99A. Spare Mounting Flange, Cat. No. 946 000 99C.



## STERN LIGHTS

**FOR USE ON SAIL OR POWER DRIVEN VESSELS UNDER 20 METERS (65.6 FT.) IN LENGTH.  
2 MILE VISIBILITY - CLEAR LENS, COMPLETE WITH 12 VOLT OR 24 VOLT BULB.**

**FIG. 120 - CHROME PLATED BRASS TOPS WITH BLACK PLASTIC BASES,  
BLACK OR WHITE PLASTIC TOPS WITH BLACK PLASTIC BASES**



**FIG. 170 - CHROME PLATED BRASS TOPS WITH BLACK PLASTIC BASES,  
BLACK OR WHITE PLASTIC TOPS WITH BLACK PLASTIC BASES**

### VERTICAL SURFACE MOUNT 12 Volt or 24 Volt Bulbs

#### ORDERING INFORMATION - FOR 12 VOLT LIGHTS

Finish	Height Overall Inches	Projection Overall Inches	Width Inches	Display Pkg. - 5 Cards 1 Pc. per Card	Std. Pkg. - 1 Pc. OEM Pkg.-10 Pcs.	Screw Size	Weight Ounces
<b>Fig. 120</b>							
Chrome	3-5/8	2-1/2	4-1/8	120 MSN DP1	120 MSN 12V	10	5
Black	3-5/8	2-1/2	4-1/8	120 BSN DP1	120 BSN 12V	10	5
White	3-5/8	2-1/2	4-1/8	120 WSN DP1	120 WSN 12V	10	5
<b>Fig. 170</b>							
Chrome	3-5/8	2-1/2	4-1/8	170 MSN DP1	170 MSN 12V	10	5
Black	3-5/8	2-1/2	4-1/8	170 BSN DP1	170 BSN 12V	10	5
White	3-5/8	2-1/2	4-1/8	170 WSN DP1	170 WSN 12V	10	5



**Figs. 120 MSN & 170 MSN**



**Figs. 120 BSN & 170 BSN**

#### ORDERING INFORMATION - FOR 24 VOLT LIGHTS

Finish	Height Overall Inches	Projection Overall Inches	Width Inches	Display Pkg. - 5 Cards 1 Pc. per Card	Std. Pkg. - 1 Pc. OEM Pkg.-10 Pcs.	Screw Size	Weight Ounces
Chrome	3-5/8	2-1/2	4-1/8	170 MSN DP2	170 MSN 24V	10	5
Black	3-5/8	2-1/2	4-1/8	170 BSN DP2	170 BSN 24V	10	5
White	3-5/8	2-1/2	4-1/8	170 WSN DP2	170 WSN 24V	10	5



**Figs. 120 WSN & 170 WSN**

NOTE: See Pages 22 through 24 for Complete Series, 24 Volt Options and Spare Parts Ordering Information.

**FIG. 1332 - CHROME PLATED ZINC WITH BLACK PLASTIC BASE**

**VERTICAL SURFACE MOUNT  
Complete with 12 Volt Bulb.**

**chromalex**

#### ORDERING INFORMATION

Length Inches	Width Inches	Display Pkg. - 5 Cards 1 Pc. per Card	OEM Bulk Pkg. 50 Pcs.	Screw Size	Weight Ounces
3-3/4	1-1/2	1332 DP CHR	1332 000 CHR	4	4

Spare Bulbs (2 per card), Cat. No. 71 DP CLR.

Spare Lenses (2 per card) Cat. No. 278 DP WHT.



**Fig. 1332**



NOTE: TO USE THIS LIGHT IN A 24 VOLT SYSTEM, ORDER REPLACEMENT BULBS (2 PER CARD) CAT. NO. 72 DP1 CLR



## MASTHEAD LIGHTS

FOR USE ON SAIL OR POWER DRIVEN VESSELS AS SPECIFIED BELOW.

**CLEAR LENS, COMPLETE WITH 12 VOLT OR 24 VOLT BULB.**



**FIG. 120 - CHROME PLATED BRASS TOPS WITH BLACK PLASTIC BASES, BLACK OR WHITE PLASTIC TOPS WITH BLACK PLASTIC BASES**

For Use On Vessels Under 12 Meters (39.4 ft.) in Length.

**VERTICAL SURFACE MOUNT**

**2 Mile Visibility - 12 Volt Bulbs.**



**Figs. 120 MM & 170 MM**

**FIG. 170 - CHROME PLATED BRASS TOPS WITH BLACK PLASTIC BASES, BLACK OR WHITE PLASTIC TOPS WITH BLACK PLASTIC BASES**

For Use On Vessels Under 20 Meters (65.6 ft.) in Length.

**VERTICAL SURFACE MOUNT**

**3 Mile Visibility - 12 Volt or 24 Volt Bulbs.**



**Figs. 120 BM & 170 BM**

**ORDERING INFORMATION - FOR 12 VOLT LIGHTS**

Finish	Height Overall Inches	Projection Overall Inches	Width Inches	Display Pkg. - 5 Cards 1 Pc. per Card	Std. Pkg. - 1 Pc. OEM Pkg.-10 Pcs.	Screw Size	Weight Ounces
<b>Fig. 120</b>							
Chrome	3-5/8	2-1/2	4-1/8	120 MM DP1	120 MM 12V	10	5
Black	3-5/8	2-1/2	4-1/8	120 BM DP1	120 BM 12V	10	5
White	3-5/8	2-1/2	4-1/8	120 WM DP1	120 WM 12V	10	5
<b>Fig. 170</b>							
Chrome	3-5/8	2-1/2	4-1/8	170 MM DP1	170 MM 12V	10	5
Black	3-5/8	2-1/2	4-1/8	170 BM DP1	170 BM 12V	10	5
White	3-5/8	2-1/2	4-1/8	170 WM DP1	170 WM 12V	10	5



**Figs. 120 WM & 170 WM**

**ORDERING INFORMATION - FOR 24 VOLT LIGHTS**

Finish	Height Overall Inches	Projection Overall Inches	Width Inches	Display Pkg. - 5 Cards 1 Pc. per Card	Std. Pkg. - 1 Pc. OEM Pkg.-10 Pcs.	Screw Size	Weight Ounces
Chrome	3-5/8	2-1/2	4-1/8	170 MM DP2	170 MM 24V	10	5
Black	3-5/8	2-1/2	4-1/8	170 BM DP2	170 BM 24V	10	5
White	3-5/8	2-1/2	4-1/8	170 WM DP2	170 WM 24V	10	5

NOTE: See Pages 22 through 24 for Complete Series, 24 Volt Options and Spare Parts Ordering Information.



**FIG. 120 - COMBINATION MASTHEAD AND DECK SPREADER LIGHT, BLACK PLASTIC**

For Use On Vessels Under 12 Meters (39.4 ft.) in Length.

**VERTICAL SURFACE MOUNT**

**2 Mile Visibility - 12 Volt Bulbs.**



**Fig. 120 BMD**

**ORDERING INFORMATION**

Height Overall Inches	Projection Overall Inches	Width Inches	Display Pkg. - 5 Cards 1 Pc. per Card	Std. Pkg. - 1 Pc. OEM Pkg. - 10 Pcs.	Screw Size	Weight Ounces
7	4-3/4	4-1/8	120 BMD DP1	120 BMD 12V	10	18-1/2

NOTE: See Pages 22 for Spare Parts Ordering Information.



## Masthead Lights

FOR USE ON SAIL OR POWER DRIVEN VESSELS AS SPECIFIED BELOW.

CLEAR LENS, COMPLETE WITH 12 VOLT BULB.

### FIG. 964 - CHROME PLATED BRASS TOP WITH BLACK PLASTIC BASE

For Use On Vessels Under 12 Meters (39.4 ft.) in Length.



**HORIZONTAL SURFACE MOUNT**  
2 Mile Visibility

chromalex®

#### ORDERING INFORMATION

O.D. Base Inches	Vertical Height Inches	Display Pkg. - 5 Cards 1 Pc. per Card	OEM Bulk Pkg. 25 Pcs.	Screw Size	Weight Ounces
2-3/8	7/8	964 DP CHR	964 000 CHR	4	3



Fig. 964

Spare Bulbs (2 per card), Cat. No. 71 DP CLR.  
Spare Lens, Cat No. 281 DPA WHT.

Spare Base with Socket Assembly, Cat. No. 135

### FIG. 1331 - CHROME PLATED ZINC WITH BLACK PLASTIC BASE

For Use On Vessels Under 20 Meters (65.6 ft.) in Length.



**VERTICAL SURFACE MOUNT**  
3 Mile Visibility

chromalex®

#### ORDERING INFORMATION

Length Inches	Width Inches	Display Pkg. - 5 Cards 1 Pc. per Card	OEM Bulk Pkg. 50 Pcs.	Screw Size	Weight Ounces
3-3/4	1-1/2	1331 DP CHR	1331 000 CHR	4	4



Fig. 1331

Spare Bulbs (2 per card), Cat. No. 71 DP CLR.

Spare Lenses (2 per card) Cat. No. 278 DP WHT.

### FIG. 1178 - BLACK PLASTIC AND CHROME PLATED ZINC TOP WITH CHROME PLATED ZINC BASE

For Use On Vessels Under 20 Meters (65.6 ft.) in Length.



**HORIZONTAL SURFACE MOUNT**  
3 Mile Visibility

chromalex®

#### ORDERING INFORMATION

Vertical Height Inches	Dimensions Base Inches	Display Pkg. - 5 Cards 1 Pc. per Card	OEM Bulk Pkg. 50 Pcs.	Screw Size	Weight Ounces
3-1/4	1 x 2-5/8	1178 DP CHR	1178 000 CHR	8	7



Fig. 1178

Spare Bulbs (2 per card), Cat. No. 71 DP CLR.  
Spare Top Cap and Screw, Cat. No. 1158 DP BLK.

Spare Lenses (2 per card), Cat. No. 278 DP WHT.

**NOTE: TO USE THE LIGHTS ON THIS PAGE IN A 24 VOLT SYSTEM, ORDER REPLACEMENT BULBS (2 PER CARD) CAT. NO. 72 DP1 CLR.**



## COMBINATION MASTHEAD AND WHITE ALL-ROUND LIGHTS

FOR USE ON SAIL OR POWER DRIVEN VESSELS UNDER 20 METERS (65.6 FT.) IN LENGTH.

**3 MILE VISIBILITY**

**CLEAR LENSES, COMPLETE WITH TWO 12 VOLT BULBS.**

**BLACK PLASTIC AND CHROME PLATED ZINC TOPS WITH CHROME PLATED ZINC BASES.**

**3/4 INCH DIAMETER ANODIZED ALUMINUM TUBES.**



**FIG. 1181 - FOLD-DOWN, ADJUSTABLE ANGLE, HORIZONTAL MOUNT  
PLASTIC ADAPTERS FOR FLAT OR "V" TYPE MOUNT,  
CONTAINS NOTCH FOR THROUGH BASE WIRING**



**FIG. 1181**

**chromalex®**

**ORDERING INFORMATION**

Vertical Height Inches	Dimensions Base Inches	Display Pkg. - 5 Cards 1 Pc. per Card	OEM Bulk Pkg. 50 Pcs.	Screw Size	Weight Pounds
12-5/8	2 x 1-1/2	1181 DP CHR	1181 000 CHR	8	3/4

Spare Bracket with Knob and End Plug, Cat. No. 1052 DPA CHR.  
Spare Knob, Cat. No. 1144 A00 BLK.

**FIG. 1184 - FOLD-DOWN, ADJUSTABLE ANGLE, HORIZONTAL MOUNT  
PLASTIC ADAPTERS FOR FLAT OR "V" TYPE MOUNT,  
CONTAINS NOTCH FOR THROUGH BASE WIRING**



**FIG. 1184**

**chromalex®**

**ORDERING INFORMATION**

Vertical Height Inches	Dimensions Base Inches	Display Pkg. - 5 Cards 1 Pc. per Card	OEM Bulk Pkg. 50 Pcs.	Screw Size	Weight Pounds
12-5/8	2-1/4 x 5/8	1184 DP CHR	1184 000 CHR	8	3/4

Spare Bracket with Knob and End Plug, Cat. No. 1054 DPA CHR.  
Spare Knob, Cat. No. 1144 A00 BLK.



**FIGS. 1183 AND 1196 - FIXED MOUNT**

**chromalex®**

**ORDERING INFORMATION**

Vertical Height Inches	Dimensions Base Inches	Display Pkg. - 5 Cards 1 Pc. per Card	OEM Bulk Pkg. 50 Pcs.	Screw Size	Weight Ounces
3-1/4	1 x 2-5/8	1183 DP CHR	1183 000 CHR	8	7
5-1/4	1 x 2-5/8	1196 DP1 CHR	1196 001 CHR	8	8
11-1/4	1 x 2-5/8	1196 DP2 CHR	1196 002 CHR	8	8



**FIG. 1183**

**FIG. 1197 - FIXED MOUNT**

**chromalex®**

**ORDERING INFORMATION**



**FIG. 1197**

Vertical Height Inches	Length Tubing Inches	Display Pkg. - 5 Cards 1 Pc. per Card	OEM Bulk Pkg. 50 Pcs.	Screw Size
3-1/4	1	1197 DP CHR	1197 000 CHR	7

**NOTE: TO USE THE LIGHTS ON THIS PAGE IN A 24 VOLT SYSTEM, ORDER REPLACEMENT BULBS (2 PER CARD) CAT. NO. 72 DP1 CLR.**

**SPARE PARTS ORDERING INFORMATION**

Spare Bulbs (2 per card), Cat. No. 71 DP CLR.  
Spare Top Cap with Screw, Cat. No. 1158 DP BLK.

Spare Lenses (2 per card), Cat. No. 278 DP WHT.



## COMBINATION MASTHEAD AND WHITE ALL-ROUND LIGHTS

FOR USE ON SAIL OR POWER DRIVEN VESSELS UNDER 20 METERS (65.6 FT.) IN LENGTH.

**STOW-A-WAY PLUG-IN TYPE**

**3 MILE VISIBILITY**

**CLEAR LENSES, COMPLETE WITH TWO 12 VOLT BULBS.**

**BLACK PLASTIC AND CHROME PLATED ZINC TOP, 3/4 INCH DIAMETER ANODIZED ALUMINUM TUBES, WATERPROOF COVER FOR BASES.**

**FIG. 1123 - HORIZONTAL MOUNT**

**FIG. 1124 - VERTICAL MOUNT**

**Chrome Plated Zinc Mounting Bracket  
Plastic Adapters for Flat or "V" Type 45 Degree Windshields**

**chromalex®**

**ORDERING INFORMATION**

Vertical Height Inches	Display Pkg. - 5 Cards 1 Pc. per Card	OEM Bulk Pkg. 50 Pcs.	Screw Size	Weight Pounds
11-1/2	1123 DP1 CHR	1123 001 CHR	8	1
11-1/2	1124 DP1 CHR	1124 001 CHR	8	1
20-3/4	1123 DP2 CHR	1123 002 CHR	8	1-1/8
20-3/4	1124 DP2 CHR	1124 002 CHR	8	1-1/8

Spare Bulb (2 per card), Cat. No. 71 DP CLR.  
Spare Lenses (2 per card), Cat. No. 278 DP WHT.  
Spare Top Cap with Screw, Cat. No. 1158 DP BLK.

Spare Cap for Base, Cat No. 125 DP BLK.  
Spare Base with Socket Assembly, Cat No. 1123 DP 99A.  
Spare Base with Socket Assembly, Cat No. 1124 DP 99A.

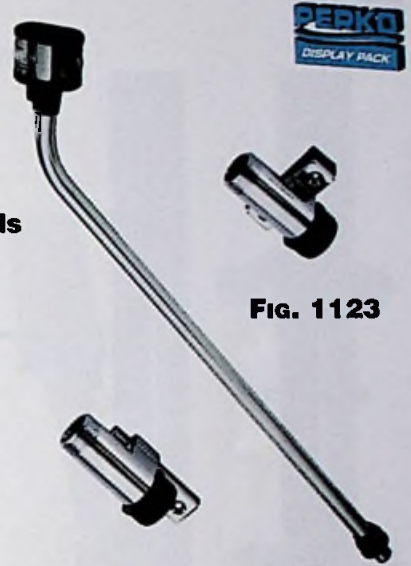

**FIG. 1123**

**FIG. 1124**

**FIG. 1125 - DECK MOUNT**

**Chrome Plated Brass Base**

**chromalex®**

**ORDERING INFORMATION**

Vertical Height Inches	Base Dimensions Inches	Display Pkg. - 5 Cards 1 Pc. per Card	OEM Bulk Pkg. 50 Pcs.	Screw Size	Weight Pounds
33-5/8	3-3/8 x 2-1/4	1125 DP4 CHR	1125 004 CHR	8	1-1/2

Spare Bulb (2 per card), Cat. No. 71 DP CLR.  
Spare Lenses (2 per card), Cat. No. 278 DP WHT.  
Spare Top Cap with Screw, Cat. No. 1158 DP BLK.

Spare Cap for Base, Cat No. 125 DP BLK.  
Spare Base with Socket Assembly, Cat No. 1125 DP 99A.  
Fig. 1125 Pole has a 16° Rake.



**FIG. 1125**

**NOTE: TO USE THE LIGHTS ON THIS PAGE IN A 24 VOLT SYSTEM, ORDER REPLACEMENT BULBS (2 PER CARD) CAT. NO. 72 DP1 CLR**



## UNIVERSAL REPLACEMENTS & WHITE ALL-ROUND LIGHTS

FOR USE ON SAIL OR POWER DRIVEN VESSELS UNDER 20 METERS (65.6 FT.) IN LENGTH.

### REPLACEMENT STOW-A-WAY PLUG-IN TYPE

2 MILE VISIBILITY

WHITE TRANSLUCENT GLOBE, BLACK PLASTIC TOP, COMPLETE WITH 12 VOLT BULB  
3/4 INCH DIAMETER ANODIZED ALUMINUM TUBES, BASES NOT INCLUDED.

FIG. 1400 - UNIVERSAL REPLACEMENT



FIG. 1400      FIG. 1600



chromalex®

### ORDERING INFORMATION

Approx. Length Inches	Display Pkg. 1 Pc. per Card	Cards Per Package	Weight Pounds
24	1400 DP2 CHR	10	1/2
30	1400 DP3 CHR	10	5/8
36	1400 DP4 CHR	10	1-1/2
42	1400 DP5 CHR	10	1-3/4
48	1400 DP6 CHR	2	2
54	1400 DP7 CHR	2	2-1/4

FIG. 1600 - REPLACEMENT PERKO LIGHTS WITH LOCKING COLLAR

chromalex®

### ORDERING INFORMATION

Approx. Length Inches	Display Pkg. 1 Pc. per Card	Cards Per Package	Weight Pounds
24	1600 DP2 CHR	10	1/2
30	1600 DP3 CHR	10	5/8
36	1600 DP4 CHR	10	1-1/2
42	1600 DP5 CHR	10	1-3/4
48	1600 DP6 CHR	2	2
54	1600 DP7 CHR	2	2-1/4

FIG. 1335 - CLEAR FRESNEL GLOBE, STOW-A-WAY, PLUG-IN TYPE LIGHT WITH CHROME PLATED BRASS BASE AND WATERPROOF COVER



FIG. 1335



2 MILE VISIBILITY

COMPLETE WITH 12 VOLT BULB.  
3/4 INCH DIAMETER ANODIZED TUBE

chromalex®

### ORDERING INFORMATION

Vertical Height Inches	Display Pkg. - 5 Cards 1 Pc. per Card	OEM Bulk Pkg. 50 Pcs.	Screw Size	Weight Pounds
40-3/8	1335 DP5 CHR	1335 005 CHR	8	1-3/8
46-1/4	1335 DP6 CHR	1335 006 CHR	8	1-1/2
51-1/4	1335 DP7 CHR	1335 007 CHR	8	1-5/8

Base Length 3-1/2", Width 1-7/8"

Spare Bulb (2 per card), Cat. No. 337 011 DP.

Spare Globe, Cat. No. 248 DP CLR.

Spare Base & Socket Assembly, Cat. No. 1048 POO DP

Fig. 1335 Pole has a 5° Rake.



## WHITE ALL-ROUND LIGHTS

FOR USE ON SAIL OR POWER DRIVEN VESSELS UNDER 20 METERS (65.6 FT.) IN LENGTH.

STOW-A-WAY PLUG-IN TYPE

2 MILE VISIBILITY

COMPLETE WITH 12 VOLT BULB

3/4 INCH DIAMETER ANODIZED TUBES,

WATER RESISTANT SLIDE COVERS & WATER PROOF COVERS FOR BASES

**FIG. 1640 - WHITE TRANSLUCENT GLOBE, BLACK PLASTIC TOP, WITH BLACK PLASTIC AND CHROME PLATED BRASS BASE**

**FIG. 1430 - WHITE TRANSLUCENT GLOBE, BLACK PLASTIC TOP, CHROME PLATED ZINC WITH BLACK PLASTIC INSERT**

**chromalex**

### ORDERING INFORMATION

#### Fig. 1430

Vertical Height Inches	Display Pkg. - 5 Cards 1 Pc. per Card	OEM Bulk Pkg. 50 Pcs.	Weight Pounds
21	1430 DP2 CHR	1430 002 CHR	1
27-1/4	1430 DP3 CHR	1430 003 CHR	1-1/8
33-1/2	1430 DP4 CHR	1430 004 CHR	1-1/4
40-3/4	1430 DP5 CHR	1430 005 CHR	1-3/8
46-3/4	1430 DP6 CHR	1430 006 CHR	1-1/2
51-3/4	1430 DP7 CHR	1430 007 CHR	1-5/8

Base Length 3-3/4", Width 1-3/4", Screw Size #8

#### Fig. 1640

20-5/8	1640 DP2 CHR	1640 002 CHR	1
27-1/8	1640 DP3 CHR	1640 003 CHR	1-1/8
33-1/4	1640 DP4 CHR	1640 004 CHR	1-1/4
40-1/2	1640 DP5 CHR	1640 005 CHR	1-3/8
46-1/2	1640 DP6 CHR	1640 006 CHR	1-1/2
51-1/2	1640 DP7 CHR	1640 007 CHR	1-5/8

Base Length 3-1/2", Width 1-1/2", Screw Size #8.

Spare Bulbs (2 per card), Cat. No. 337 012 DP. Spare Globe, Cat. No. 201 DP WHT.

Spare Bases with Socket Assembly for Fig. 1640, Cat. No. 1046 P00 DP.

Spare Bases with Socket Assembly for Fig. 1430, Cat. No. 1060 P00 DP.

Fig. 1430 Pole and Fig. 1640 Pole have a 5° Rake.



Fig. 1430



Fig. 1640

**FIG. 1631 & FIG. 1660 - WHITE TRANSLUCENT GLOBE, BLACK PLASTIC TOP, WITH BLACK PLASTIC AND CHROME PLATED BRASS BASE**

**chromalex**

### ORDERING INFORMATION

#### Fig. 1631

Vertical Height Inches	Display Pkg. - 5 Cards 1 Pc. per Card	OEM Bulk Pkg. 50 Pcs.	Weight Pounds
40-1/4	1631 DP5 CHR	1631 005 CHR	1-3/8
46-3/4	1631 DP6 CHR	1631 006 CHR	1-1/2
51-3/4	1631 DP7 CHR	1631 007 CHR	1-5/8

O.D. Base 2-1/4", Screw Size #8.

#### Fig. 1660

40-5/8	1660 DP5 CHR	1660 005 CHR	1-3/8
46-5/8	1660 DP6 CHR	1660 006 CHR	1-1/2
51-5/8	1660 DP7 CHR	1660 007 CHR	1-5/8

Base Length 3-1/2", Width 1-1/2", Screw Size #8.

Spare Bulbs (2 per card), Cat. No. 337 012 DP. Spare Globe, Cat. No. 201 DP WHT.

Spare Bases with Socket Assembly for Fig. 1631, Cat. No. 1045 P00 DP.

Spare Bases with Socket Assembly for Fig. 1660, Cat. No. 1047 P00 DP.



Fig. 1631



Fig. 1660



## WHITE ALL-ROUND LIGHTS

FOR USE ON SAIL \* OR POWER DRIVEN VESSELS UNDER 20 METERS (65.6 FT.) IN LENGTH.

TELESCOPING TYPE

2 MILE VISIBILITY  
COMPLETE WITH 12 VOLT BULB  
3/4 INCH DIAMETER ANODIZED TUBES

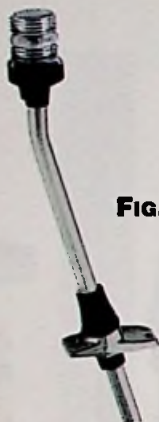

Fig. 1311

FIG. 1311 - CLEAR FRESNEL GLOBE, BLACK PLASTIC TOP, CHROME PLATED ZINC BASE

\*For Use On Power Driven Vessels Only.

chromolex®

### ORDERING INFORMATION

Vertical Height Inches	Display Pkg. - 5 Cards 1 Pc. perCard	OEM Bulk Pkg. 50 Pcs.	Weight Pounds
20-1/2	1311 DP2 CHR	1311 002 CHR	7/8
26-5/8	1311 DP3 CHR	1311 003 CHR	1
32-1/2	1311 DP4 CHR	1311 004 CHR	1-1/8

Base Length 3-3/4", Width 1-5/8", Screw Size #8.

Spare Bulb (2 per card), Cat. No. 337 011 DP.  
Spare Globe, Cat. No. 248 DP CLR.

Spare Base, Cat No. 1059 T00 DP.  
Fig. 1311 has a 16° Rake.



Fig. 1611

FIG. 1611 - WHITE TRANSLUCENT GLOBE, BLACK PLASTIC TOP, CHROME PLATED ZINC BASE

chromolex®

### ORDERING INFORMATION

Vertical Height Inches	Display Pkg. - 5 Cards 1 Pc. per Card	OEM Bulk Pkg. 50 Pcs.	Weight Pounds
20-3/4	1611 DP2 CHR	1611 002 CHR	7/8
26-7/8	1611 DP3 CHR	1611 003 CHR	1
32-3/4	1611 DP4 CHR	1611 004 CHR	1-1/8

Base Length 3-3/4", Width 1-5/8", Screw Size #8.

Spare Bulb (2 per card), Cat. No. 337 011 DP.  
Spare Globe, Cat. No. 201 DP WHT.

Spare Base, Cat No. 1059 T00 DP.  
Fig. 1611 has a 16° Rake.



Fig. 1411

FIG. 1411 - WHITE TRANSLUCENT GLOBE, BLACK PLASTIC TOP, CHROME PLATED ZINC BASE WITH BLACK PLASTIC INSERT

chromolex®

### ORDERING INFORMATION

Vertical Height Inches	Display Pkg. - 5 Cards 1 Pc. per Card	OEM Bulk Pkg. 50 Pcs.	Weight Pounds
21	1411 DP2 CHR	1411 002 CHR	7/8
27-1/4	1411 DP3 CHR	1411 003 CHR	1
33-1/2	1411 DP4 CHR	1411 004 CHR	1-1/8

Base Length 3-3/4", Width 1-3/4", Screw Size #8.

Spare Bulb (2 per card), Cat. No. 337 012 DP.  
Spare Globe, Cat. No. 201 DP WHT.

Spare Base, Cat No. 1060 T00 DP.  
Fig. 1411 has a 5° Rake.



## WHITE ALL-ROUND LIGHTS

FOR USE ON POWER\* DRIVEN VESSELS UNDER 20 METERS (65.6 FT.) IN LENGTH.

**STOW-A-WAY PLUG-IN TYPE**

**2 MILE VISIBILITY  
COMPLETE WITH 12 VOLT BULB  
3/4 INCH DIAMETER ANODIZED TUBES,  
WATERPROOF COVER FOR BASES**

**FIG. 1330 - CLEAR FRESNEL GLOBE, BLACK PLASTIC TOP,  
CHROME PLATED ZINC BASE**

**chromalex®**

**ORDERING INFORMATION**

Vertical Height Inches	Display Pkg. - 5 Cards 1 Pc. per Card	OEM Bulk Pkg. 50 Pcs.	Weight Pounds
20-1/2	1330 DP2 CHR	1330 002 CHR	1
26-5/8	1330 DP3 CHR	1330 003 CHR	1-1/8
32-1/2	1330 DP4 CHR	1330 004 CHR	1-1/4

Base Length 3-3/4", Width 1-5/8", Screw Size #8.

Spare Bulbs (2 per card), Cat. No. 337 011 DP.

Spare Base with Socket Assembly, Cat. No. 1059 P00 DP.

Spare Globe, Cat. No. 248 DP CLR.

Fig. 1330 Pole has a 16° Rake.

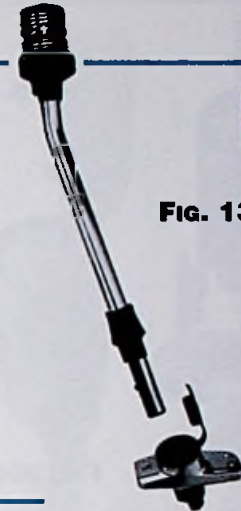

**FIG. 1330**

**FIG. 1630 - WHITE TRANSLUCENT GLOBE, BLACK PLASTIC TOP,  
CHROME PLATED ZINC BASE**

**chromalex®**

**ORDERING INFORMATION**

Vertical Height Inches	Display Pkg. - 5 Cards 1 Pc. per Card	OEM Bulk Pkg. 50 Pcs.	Weight Pounds
20-3/2	1630 DP2 CHR	1630 002 CHR	1
26-7/8	1630 DP3 CHR	1630 003 CHR	1-1/8
32-3/4	1630 DP4 CHR	1630 004 CHR	1-1/4
40	1630 DP5 CHR	1630 005 CHR	1-3/8
45-1/2	1630 DP6 CHR	1630 006 CHR	1-1/2
50-1/2	1630 DP7 CHR	1630 007 CHR	1-5/8

Base Length 3-3/4", Width 1-5/8", Screw Size #8.

Spare Bulbs (2 per card), Cat. No. 337 012 DP.

Spare Base with Socket Assembly, Cat. No. 1059 P00 DP.

Spare Globe, Cat. No. 201 DP WHT.

Fig. 1630 Pole has a 16° Rake.



**FIG. 1630**

**FIG. 1209 - CLEAR FRESNEL GLOBE,  
CHROME PLATED BRASS TOP AND BASE**

**chromalex®**

**ORDERING INFORMATION**

Vertical Height Inches	Display Pkg. - 5 Cards 1 Pc. per Card	OEM Bulk Pkg. 50 Pcs.	Weight Pounds
21-3/8	1209 DP2 CHR	1209 002 CHR	1
28-3/8	1209 DP3 CHR	1209 003 CHR	1-1/4
34	1209 DP4 CHR	1209 004 CHR	1-1/2

Base Length 3-3/8", Width 2-1/4", Screw Size #8.

Spare Bulbs (2 per card), Cat. No. 337 011 DP.

Spare Globe, Cat. No. 248 DP CLR.

Spare Base with Socket Assembly, Cat. No. 1209 DP 99A.

Spare Bulb Socket, Cat. No. 24 DP2.

Spare Cap for Base, Cat. No. 125 DP BLK.

Fig. 1209 Pole has a 16° Rake.

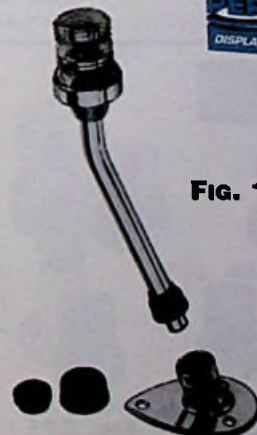

**FIG. 1209**



## ALL-ROUND LIGHTS

FOR USE ON SAIL\* OR POWER DRIVEN VESSELS UNDER 20 METERS (65.6 FT.) IN LENGTH.  
2 MILE VISIBILITY



### FIG. 108 - CAST ZINC, BLACK PERKO-KOTE FINISH FESTOON TYPE ELECTRICAL SOCKET

\*For Power Driven Vessels Only.

### FIGS. 112 & 309 - CAST BRONZE, PLAIN OR CHROME PLATED MEDIUM SCREW BASE TYPE ELECTRICAL SOCKET

For 12 or 32 Volts. Bulb Not Included.



FIG. 112



FIG. 309

Fig.	Height Overall Inches	O.D. Base Inches	Tapped Pipe Size Inches	Screw Size	Weight Pounds
108	6	3-1/8	1/2*	10	2
112	8-3/4	3-1/8	---	8	2-1/2
309	6-1/2	-----	1/2	---	2-1/4

### ORDERING INFORMATION

Description	Plain Bronze Standard Pkg. - 1 Pc.	Chrome Plated Bronze Standard Pkg. - 1 Pc.	Black Powder Coat Zinc Display Pkg.- 5 pcs. 1 Pc. per Box	Black Powder Coat Zinc Standard Pkg. - 1 Pc.
White All-Round	112 B00 PLB	112 B00 CHR	108 DP BLK**	108 000 BLK**
Red All-Round	112 RB0 PLB	112 RB0 CHR	108 DPR BLK	108 R00 BLK
Green All-Round	112 GB0 PLB	112 GB0 CHR	108 DPG BLK	108 G00 BLK
Yellow All-Round	112 MB0 PLB	112 MB0 CHR	-----	-----
White All-Round	309 B00 PLB	309 B00 CHR		
Red All-Round	309 RB0 PLB	309 RB0 CHR		
Green All-Round	309 GB0 PLB	309 GB0 CHR		
Yellow All-Round	309 MB0 PLB	309 MB0 CHR		



FIG. 108

\*Base Removable for Flush Mounting.

\*\*These Lights Are Supplied with a Gray Tinted Globe.

### SPARE PARTS ORDERING INFORMATION

#### Spare Globes:

White, Cat. No. 106 000 WHT.  
Gray, Cat. No. 106 000 GRY.  
Red, Cat. No. 106 000 RED.  
Green, Cat. No. 106 000 GRN.  
Yellow, Cat. NO. 106 000 YLW.

#### Required Bulbs:

12 Volts for Fig. 108 (2 Per Card), Cat. No. 70 DP1 CLR.  
12 Volts for White and Yellow Figs. 112 and 309, Cat. No. 340 005 FRD.  
12 Volts for Red and Green Figs. 112 and 309, Cat. No. 340 006 FRD.  
32 Volts for Fig. 108 (2 per Card), Cat. No. 70 DP2 CLR.  
32 Volts for White and Yellow Figs. 112 and 309, Cat. No. 340 011 FRD.  
32 Volts for Red and Green Figs. 112 and 309, Cat. No. 340 012 FRD.

Spare Medium Screw Base Socket, Cat. No. 226.

Spare Base and Gasket for Fig. 108, Cat. No. 222 DP BLK.



### FIGS. 362 & 371 - FROSTED GLOBE, CAST BRONZE, PLAIN OR CHROME PLATED

Double Contact Socket, Complete with 12 Volt Bulb.

### ORDERING INFORMATION



FIG. 362

FIG. 371

Vertical Height Inches	O.D. Base Inches	Plain Bronze Display Pkg.- 5 Cards 1 Pc. per Card	Chrome Plated Bronze Display Pkg.- 5 Cards 1 Pc. per Card	Screw Size	Tapped Pipe Size Inches	Weight Ounces
2-3/8	-----	362 DP PLB	362 DP CHR	-----	1/2	8
1-5/8	2-1/2	371 DP PLB	371 DP CHR	8 F.H.	-----	10

Spare Bulbs (2 per card), Cat. No. 337 011 DP  
Spare Socket, Cat. No. 24 DP1.

Spare Globe, Cat. No. 248 000 FRD.



## WHITE ALL-ROUND LIGHTS

FOR USE ON SAIL\* OR POWER DRIVEN VESSELS UNDER 20 METERS (65.6 FT.) IN LENGTH.

2 MILE VISIBILITY

COMPLETE WITH 12 VOLT BULB.

BLACK PLASTIC TOPS, CHROME PLATED BASES  
3/4 INCH ANODIZED ALUMINUM TUBES

**FIG. 1620 - WHITE TRANSLUCENT GLOBE, STOW-A-WAY, PLUG-IN TYPE LIGHT WITH CHROME PLATED BRASS BASE AND WATERPROOF COVER**



chromalex®

### ORDERING INFORMATION

Vertical Height Inches	Display Pkg. - 5 Cards 1 Pc. per Card	OEM Bulk Pkg. 50 Pcs.	Screw Size	Weight Pounds
40-1/2	1620 DP5 CHR	1620 005 CHR	8	1-3/8
46-3/4	1620 DP6 CHR	1620 006 CHR	8	1-1/2
57-3/4	1620 DP7 CHR	1620 007 CHR	8	1-5/8

Base Length 3-1/2", Width 1-7/8"

Spare Bulb (2 per card), Cat. No. 337 012 DP.

Spare Globe, Cat. No. 201 DP WHT.

Spare Base & Socket Assembly, Cat. No. 1048 POO DP

Fig. 1620 Pole has a 5° Rake.



FIG. 1620

**FIG. 1134 - WHITE TRANSLUCENT GLOBE, HORIZONTAL MOUNT, FOLD-DOWN ADJUSTABLE ANGLE**

**FIG. 1137 - WHITE TRANSLUCENT GLOBE, VERTICAL MOUNT, FOLD-DOWN ADJUSTABLE ANGLE**

### CHROME PLATED ZINC BASES

PLASTIC ADAPTERS FOR "V" OR FLAT MOUNT & 12 VOLT BULB INCLUDED

chromalex®

### ORDERING INFORMATION

Vertical Height Inches	Dimensions Base Inches	Display Pkg. - 5 Cards 1 Pc. per Card	OEM Bulk Pkg. 50 Pcs.	Screw Size	Weight Ounces
13-5/8	2 x 1-1/2	1134 DP CHR	1134 000 CHR	8	13
13-5/8	2-1/4 x 5/8	1137 DP CHR	1137 000 CHR	8	13

Spare Bulb (2 per card), Cat. No. 337 012 DP.

Spare Knob, Cat. No. 1144 A00 BLK.

Spare Globe, Cat. No. 201 DP WHT.

Spare Bracket with Knob and End Plug for Fig. No. 1134, Cat. No. 1052 DP CHR.

Spare Bracket with Knob and End Plug for Fig. No. 1137, Cat. No. 1054 DP CHR.



FIG. 1134



FIG. 1137

**FIG. 455 - CLEAR FRESNEL GLOBE, FIXED MOUNT**

CHROME PLATED ZINC BASE

COMPLETE WITH 12 VOLT BULB.

chromalex®

\*For Use on Power Driven Vessels Only

### ORDERING INFORMATION

Vertical Height Inches	O.D. Base Inches	Display Pkg. - Cards 1 Pc. per Card	OEM Bulk Pkg. 50 Pcs.	Screw Size	Weight Ounces
4-1/2	2-1/16	455 DP1 CHR	455 001 CHR	8	12
11	2-1/16	455 DP2 CHR	455 002 CHR	8	16

Spare Bulb (2 per card), Cat. No. 337 011 DP.

Spare Globe, Cat. No. 248 DP CLR.



FIG. 455



## White All-Round Lights, Pole Storage Clips & Glare Shield

FOR USE ON SAIL OR POWER DRIVEN VESSELS UNDER 20 METERS (65.6 FT.) IN LENGTH.

**2 MILE VISIBILITY**  
**COMPLETE WITH 12 VOLT OR 24 VOLT BULB AS SPECIFIED BELOW.**  
**BLACK PLASTIC TOPS, CHROME PLATED ZINC BASES**  
**3/4 INCH ANODIZED ALUMINUM TUBES**

### FIG. 1301 - WHITE TRANSLUCENT GLOBE, FIXED MOUNT



Fig. 1301

**12 VOLT BULB**  
**chromalex®**

#### ORDERING INFORMATION

Vertical Height Inches	Dimensions Base Inches	Display Pkg. - 5 Cards 1 Pc. per Card	OEM Bulk Pkg. 50 Pcs.	Screw Size	Weight Ounces
7-1/8	1 x 2-5/8	1301 DP CHR	1301 000 CHR	8	8

Spare Bulb (2 per card), Cat. No. 337 012 DP. Spare Globe, Cat. No. 201 DP WHT.



### FIG. 120 SWB - WHITE TRANSLUCENT GLOBE, FIXED MOUNT, 12 VOLT BULB FIG. 170 SWB - WHITE TRANSLUCENT GLOBE, FIXED MOUNT, 24 VOLT BULB



Figs. 120 SWB & 170 SWB

**CHROME PLATED ZINC BASE**

**chromalex®**

#### ORDERING INFORMATION

Vertical Height Inches	Dimensions Base Inches	Display Pkg. - 5 Cards 1 Pc. per Card	OEM Bulk Pkg. 50 Pcs.	Screw Size	Weight Ounces
3-3/4	1 x 2-5/8	120 SWB DP1	120 SWB 12V	8	7
3-3/4	1 x 2-5/8	170 SWB DP2	170 SWB 24V	8	7

Spare 12 Volt Bulbs (2 per card), Cat. No. 337 012 DP. Spare 24 Volt Bulb, Cat. No. 337 014 DP. Spare Globe, Cat. No. 201 DP WHT.



Fig. 477

### FIG. 477 - POLE STORAGE CLIPS

**SOFT RUBBER**

**FITS 3/4 INCH DIAMETER TUBING**

#### ORDERING INFORMATION

Display Pkg. - 10 Cards 1 Pair. per Card	OEM Bulk Pkg. 50 Pair	Screw Size	Weight per Pair Ounces
477 DP BLK	477 000 BLK	8 P.H.	3



Fig. 1192

### GLARE SHIELD - FIG. 1192

**Black Plastic**

For 3/4 Inch O.D. Tubing, Can Be Installed Without Removing Light

#### ORDERING INFORMATION

Dimensions Inches	Display Pkg. - 5 Bags 1 Pc. per Bag	OEM Bulk Pkg. 25 Pcs.	Weight Ounces
6 x 4-5/16	1192 DP BLK	1192 000 BLK	3





## NAVIGATION LIGHT VERTICAL HEIGHTS

NOTE: Vertical Height "H" is Measured from the Center of the Bulb Filament to the Mounting Surface and May be Used as a Generalized Guide for the Selection of Lights in Accordance with the Vertical Light Separation Requirements of Navigation Regulations.

### BI-COLOR LIGHTS

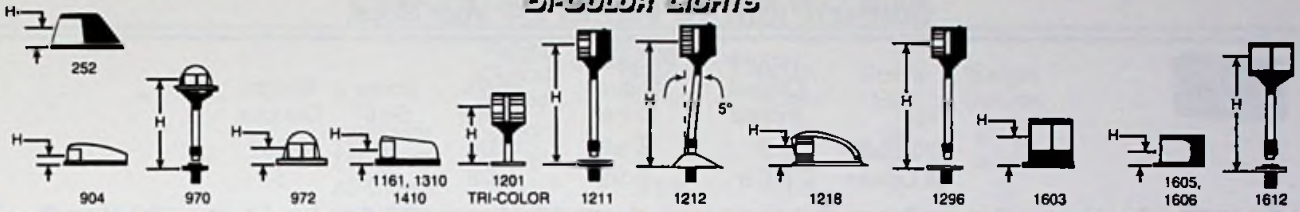

### Bi-Color Lights

FIG.	252	904	970	972	1161	1201	1211	1212	1218	1296	1310	1410	1603	1605	1606	1612
H	1-5/8	7/8	9-3/4	7/8	1	3-1/4	10	10-1/4	1-5/8	10	1	1	1-1/8	5/8	5/8	9-3/4

### WHITE ALL-ROUND LIGHTS

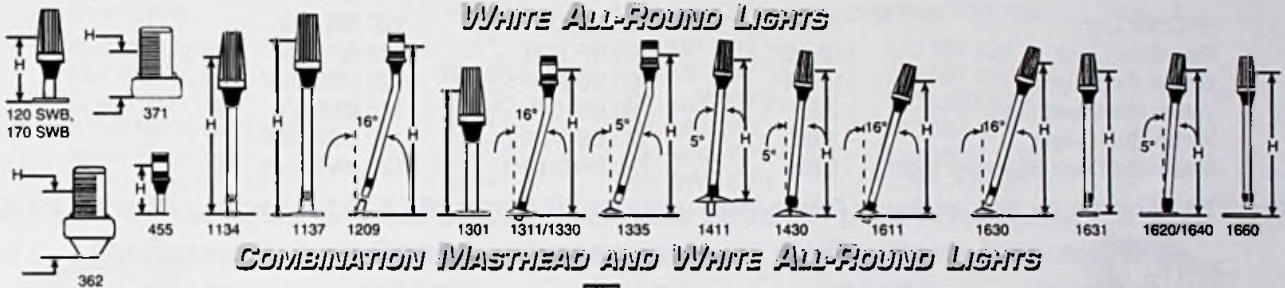

### COMBINATION MASTHEAD AND WHITE ALL-ROUND LIGHTS

		DIMENSIONS						
SIZE		1	2	3	4	5	6	7
FIG.	H	H	H	H	H	H	H	H
<b>WHITE ALL-ROUND LIGHTS</b>								
120 SWB	3-3/4							
170 SWB	3-3/4							
362	2-3/8							
371	1-5/8							
455		4-1/2	11					
1134	13-5/8							
1137	13-5/8							
1209			21-3/8	28-3/8	34			
1301	7-1/8							
1311			20-1/2	26-5/8	32-1/2			
1330			20-1/2	26-5/8	32-1/2			
1335						40-3/8	46-1/4	51-1/4
1411			21	27-1/4	33-1/2			
1430			21	27-1/4	33-1/2	40-3/4	46-3/4	51-3/4
1611			20-3/4	26-7/8	32-3/4			
1620						40-1/4	46-3/4	57-3/4
1630			20-3/4	26-7/8	32-3/4	40	45-1/2	50-1/2
1631						40-1/4	46-3/4	51-3/4
1640			20-5/8	27-1/8	33-1/4	40-1/2	46-1/2	51-1/2
1660						40-5/8	46-5/8	51-5/8
<b>COMBINATION MASTHEAD AND WHITE ALL-ROUND LIGHTS</b>								
1123			11-1/2	20-3/4				
1124			11-1/2	20-3/4				
1125					33-5/8			
1181	12-5/8							
1183	3-1/4							
1184	12-5/8							
1196		5-1/4	11-1/4					
1197	4							

### SIDE LIGHTS

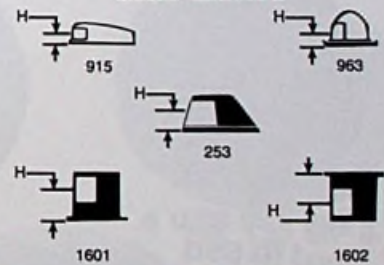

		SIDE LIGHTS				
FIG.		253	915	963	1601	1602
H		1-5/8	7/8	7/8	1-1/8	1-1/8

### MASTHEAD LIGHTS

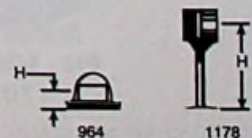

		MASTHEAD LIGHTS	
FIG.		964	1178
H		7/8	3-1/4



## NAVIGATION LIGHTS

FOR USE ON SAIL OR POWER DRIVEN VESSELS AS SPECIFIED BELOW.

**BLACK PLASTIC.**

**COMPLETE WITH 12 VOLT OR 24 VOLT BULB.**



Fig.	Height Overall Inches	Projection Overall Inches	Width Inches	Screw Size	Weight Ounces
120 BMD	7	4-3/4	4-1/8	10	18-1/2
All Others	3-5/8	2-1/2	4-1/8	10	5

**FIG. 120 - FOR USE ON SAIL OR POWER DRIVEN VESSELS UNDER 12 METERS (39.4 FT.) IN LENGTH. (12 VOLT ONLY)**

### ORDERING INFORMATION

Description	Visibility Arc	Display Pkg. - 5 Cards 1 Pc. per Card	Std Pkg. - 1 Pc. OEM Pkg. - 10 Pcs.	Visibility Miles
Bi-Color Light	225°	120 BB DP1	120 BB 12V	1
Red Side Light	112-1/2°	120 BP DP1	120 BP 12V	1
Green Side Light	112-1/2°	120 BSD DP1	120 BSD 12V	1
White Masthead Light	225°	120 BM DP1	120 BM 12V	2
White Stern Light	135°	120 BSN DP1	120 BSN 12V	2
Masthead/Deck Spreader Light	225°	120 BMD DP1	120 BMD 12V	2

**FIG. 170 - FOR USE ON SAIL OR POWER DRIVEN VESSELS UNDER 20 METERS (65.6 FT.) IN LENGTH. (12 OR 24 VOLT)**



### ORDERING INFORMATION

### ORDERING INFORMATION

Description	Visibility Arc	12 Volt		24 Volt		Visibility Miles
		Display Pkg. - 5 Cards 1 Pc. per Card	Std Pkg. - 1 Pc. OEM Pkg. - 10 Pcs	Display Pkg. - 5 Cards 1 Pc. per Card	Std Pkg. - 1 Pc. OEM Pkg. - 10 Pcs	
Bi-Color Light*	225°	170 BB DP1	170 BB 12V	170 BB DP2	170 BB 24V	2
Red Side Light	112-1/2°	170 BP DP1	170 BP 12V	170 BP DP2	170 BP 24V	2
Green Side Light	112-1/2°	170 BSD DP1	170 BSD 12V	170 BSD DP2	170 BSD 24V	2
White Masthead Light	225°	170 BM DP1	170 BM 12V	170 BM DP2	170 BM 24V	3
White Stern Light	135°	170 BSN DP1	170 BSN 12V	170 BSN DP2	170 BSN 24V	2

\*New Items



**FIG. 120 BSD & 170 BSD**



**FIG. 120 BB & 170 BB\***



**FIG. 120 BP & 170 BP**

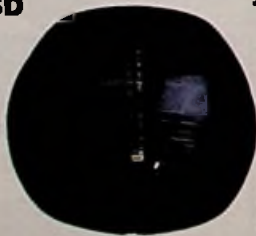

**FIG. 120 BSN & 170 BSN**



**FIG. 120 BM & 170 BM**



**FIG. 120 BMD**

### SPARE PARTS ORDERING INFORMATION

Spare Halogen Bulb for Deck Spreader Light, Cat. No. 68 12V 20W. Spare Bulbs (2 per card) for 170 BSN (24 Volt), Cat. No. 67 DP1 CLR.  
 Spare Bulbs (2 per card) for All Other 120's, Cat. No. 69 DP CLR. Spare Bulbs (2 per card) for All Other 12 Volt 170's, Cat. No. 70 DP1 CLR.  
 Spare Bulbs (2 per card) for 170 BSN (12 Volt), Cat. No. 69 DP CLR. Spare Bulbs (2 per card) for All Other 24 Volt 170's, Cat. No. 67 DP2 CLR.

For Spare Lens and Shield Assembly, Replace the Last Three Digits of the Catalog Number with the Letters "LNS" (e.g., 120 BB LNS, for a Black Shield and Bi-Color Lens).



## NAVIGATION LIGHTS

**FOR USE ON SAIL OR POWER DRIVEN VESSELS AS SPECIFIED BELOW.  
CHROME PLATED BRASS WITH BLACK PLASTIC BASE.  
COMPLETE WITH 12 VOLT OR 24 VOLT BULB.**

Fig.	Height Overall Inches	Projection Overall Inches	Width Inches	Screw Size	Weight Ounces
120 SWB	5-1/8*	-----	2-1/2	8	4-1/2
170 SWB	5-1/8*	-----	2-1/2	8	4-1/2
All Others	3-5/8	2-1/2	4-1/8	10	5



\*Vertical Height - 3-3/4 Inches.

**FIG. 120 - FOR USE ON SAIL OR POWER DRIVEN VESSELS UNDER 12 METERS (39.4 FT.) IN LENGTH. (12 VOLT ONLY)**  
**ORDERING INFORMATION**

Description	Visibility Arc	Display Pkg. - 5 Cards 1 Pc. per Card	Std Pkg. - 1 Pc. OEM Pkg. - 10 Pcs.	Visibility Miles
Bi-Color Light	225°	120 MB DP1	120 MB 12V	1
Red Side Light	112-1/2°	120 MP DP1	120 MP 12V	1
Green Side Light	112-1/2°	120 MSD DP1	120 MSD 12V	1
White Masthead Light	225°	120 MM DP1	120 MM 12V	2
White Stern Light	135°	120 MSN DP1	120 MSN 12V	2
White All-Round Light	360°	120 SWB DP1	120 SWB 12V**	2

**FIG. 170 - FOR USE ON SAIL OR POWER DRIVEN VESSELS UNDER 20 METERS (65.6 FT.) IN LENGTH. (12 OR 24 VOLT)**  
**ORDERING INFORMATION**

Description	Visibility Arc	12 Volt		24 Volt		Visibility Miles
		Display Pkg. - 5 Cards 1 Pc. per Card	Std Pkg. - 1 Pc. OEM Pkg. - 10 Pcs.	Display Pkg. - 5 Cards 1 Pc. per Card	Std Pkg. - 1 Pc. OEM Pkg. - 10 Pcs.	
Bi-Color Light*	225°	170 MB DP1	170 MB 12V	170 MB DP2	170 MB 24V	2
Red Side Light	112-1/2°	170 MP DP1	170 MP 12V	170 MP DP2	170 MP 24V	2
Green Side Light	112-1/2°	170 MSD DP1	170 MSD 12V	170 MSD DP2	170 MSD 24V	2
White Masthead Light	225°	170 MM DP1	170 MM 12V	170 MM DP2	170 MM 24V	3
White Stern Light	135°	170 MSN DP1	170 MSN 12V	170 MSN DP2	170 MSN 24V	2
White All-Round Light	360°	(See 120 SWB Above)	(See 120 SWB Above)	170 SWB DP2	170 SWB 24V**	2

\* New Item

\*\*OEM Bulk Pkg. - 50 pcs.



**FIG. 120 MSD &  
170 MSD**



**FIG. 120 MB &  
170 MB\***



**FIG. 120 MP &  
170 MP**



**FIG. 120 MSN &  
170 MSN**



**FIG. 120 MM &  
170 MM**



**FIG. 120 SWB &  
170 SWB**

### SPARE PARTS ORDERING INFORMATION

Spare Bulbs (2 per card) for 120 SWB, Cat. No. 337 012 DP.

Spare Bulb for 170 SWB (24 Volt), Cat. No. 337 014 DP.

Spare Bulbs (2 per card) for All Other 120's, Cat. No. 69 DP CLR.

Spare Bulbs (2 per card) for 170 MSN (12 Volt), Cat. No. 69 DP CLR.

Spare Bulbs (2 per card) for 170 MSN (24 Volt), Cat. No. 67 DP1 CLR.

Spare Bulbs (2 per card) for All Other 12 Volt 170's, Cat. No. 70 DP1 CLR.

Spare Bulbs (2 per card) for All Other 24 Volt 170's, Cat. No. 67 DP2 CLR.

For Spare Lens and Shield Assembly, Replace the Last Three Digits of the Catalog Number with the Letters "LNS" (e.g., 120 MM LNS, for a Chrome Plated Brass Shield and Bi-Color Lens).



## NAVIGATION LIGHTS

FOR USE ON SAIL OR POWER DRIVEN VESSELS AS SPECIFIED BELOW.

**WHITE PLASTIC WITH BLACK PLASTIC BASE.  
COMPLETE WITH 12 VOLT OR 24 VOLT BULB.**



Height Overall Inches	Projection Overall Inches	Width Inches	Screw Size	Weight Ounces
3-5/8	2-1/2	4-1/8	10	5

FIG. 120 - FOR USE ON SAIL OR POWER DRIVEN VESSELS UNDER 12 METERS (39.4 FT.) IN LENGTH. (12 VOLT ONLY)

### ORDERING INFORMATION

Description	Visibility Arc	Display Pkg. - 5 Cards 1 Pc. per Card	Std Pkg. - 1 Pc. OEM Pkg. - 10 Pcs.	Visibility Miles
Bi-Color Light	225°	120 WB DP1	120 WB 12V	1
Red Side Light	112-1/2°	120 WP DP1	120 WP 12V	1
Green Side Light	112-1/2°	120 WSD DP1	120 WSD 12V	1
White Masthead Light	225°	120 WM DP1	120 WM 12V	2
White Stern Light	135°	120 WSN DP1	120 WSN 12V	2

FIG. 170 - FOR USE ON SAIL OR POWER DRIVEN VESSELS UNDER 20 METERS (65.6 FT.) IN LENGTH. (12 OR 24 VOLT)



### ORDERING INFORMATION

### ORDERING INFORMATION

Description	Visibility Arc	12 Volt		24 Volt		Visibility Miles
		Display Pkg. - 5 Cards 1 Pc. per Card	Std Pkg. - 1 Pc. OEM Pkg. - 10 Pcs.	Display Pkg. - 5 Cards 1 Pc. per Card	Std Pkg. - 1 Pc. OEM Pkg. - 10 Pcs.	
Bi-Color Light*	225°	170 WB DP1	170 WB 12V	170 WB DP2	170 WB 24V	2
Red Side Light	112-1/2°	170 WP DP1	170 WP 12V	170 WP DP2	170 WP 24V	2
Green Side Light	112-1/2°	170 WSD DP1	170 WSD 12V	170 WSD DP2	170 WSD 24V	2
White Masthead Light	225°	170 WM DP1	170 WM 12V	170 WM DP2	170 WM 24V	3
White Stern Light	135°	170 WSN DP1	170 WSN 12V	170 WSN DP2	170 WSN 24V	2

\* New Item



FIG. 120 WSD &  
170 WSD



FIG. 120 WB &  
170 WB\*



FIG. 120 WP &  
170 WP



FIG. 120 WSN &  
170 WSN



FIG. 120 WM &  
170 WM

### SPARE PARTS ORDERING INFORMATION

Spare Bulbs (2 per card) for All 120's, Cat. No. 69 DP CLR.

Spare Bulbs (2 per card) for 170 WSN (24 Volt), Cat. No. 67 DP1 CLR.

Spare Bulbs (2 per card) for 170 WSN (12 Volt), Cat. No. 69 DP CLR.

Spare Bulbs (2 per card) for All Other 24 Volt 170's, Cat. No. 67 DP2 CLR.

Spare Bulbs (2 per card) for All Other 12 Volt 170's, Cat. No. 70 DP1 CLR

For Spare Lens and Shield Assembly, Replace the Last Three Digits of the Catalog Number with the Letters "LNS" (e.g., 120 WB LNS, for a White Shield and Bi-Color Lens).



## NAVIGATION LIGHTS

**FOR USE ON SAIL OR POWER DRIVEN VESSELS UNDER 20 METERS (65.6 FT.) IN LENGTH.**

### TOP MOUNT.

**BLACK PLASTIC WITH STAINLESS STEEL MOUNTING BRACKET.  
COMPLETE WITH 12, 24 OR 32 VOLT BULB.**

Height Overall Inches	Projection Inches	Height Lens Inches	Screw Size	Weight Ounces
4-13/16	3-5/16	2-3/4	8	12-1/2



### ORDERING INFORMATION - FOR 12 VOLT LIGHTS

Description	Visibility Arc	Display Pkg. - 5 Cards 1 Pc. per Card	Std. Pkg. - 1 Pc. OEM Pkg. - 10 Pcs.	Visibility Miles	Replacement Bulb
Bi-Color Light	225°	200 BT DP1	200 BT 12V	2	375 12V 25W
Red Side Light	112-1/2°	200 PT DP1	200 PT 12V	2	375 12V 25W
Green Side Light	112-1/2°	200 SDT DP1	200 SDT 12V	2	375 12V 25W
White Masthead Light	225°	200 MT DP1	200 MT 12V	3	375 12V 25W
White Stern Light	135°	200 SNT DP1	200 SNT 12V	2	375 12V 10W
Yellow Towing Light	135°	200 TWT DP1	200 TWT 12V	2	375 12V 10W

### ORDERING INFORMATION - FOR 24 VOLT LIGHTS

Replace the "DP1" with "DP2" For Display Package or the "12V" with "24V" For Standard Package or OEM Package (e.g., 200 BT DP2 or 200 BT 24V). For the Replacement Bulb, Replace the "12V" with "24V" (e.g., 375 24V 25W).

### ORDERING INFORMATION - FOR 32 VOLT LIGHTS

Replace the "DP1" with "DP3" For Display Package or the "12V" with "32V" For Standard Package or OEM Package (e.g., 200 BT DP3 or 200 BT 32V). For the Replacement Bulb, Replace the "12V" with "32V" (e.g., 375 32V 25W).



**FIG. 200 SNT**



**FIG. 200 TWT**

**FIG. 200 SERIES TOP MOUNT**



**FIG. 200 PT**



**FIG. 200 BT**



**FIG. 200 SDT**

### SPARE PARTS ORDERING INFORMATION

Spare Lens Assembly Part Numbers are Determined by Replacing the Last Three Digits of the Catalog Number with the Letters "LNS" (e.g., 200 BT LNS, for a Bi-Color Top Mount Lens Assembly).  
Spare Replacement Bulb Socket, Cat No. 93



## NAVIGATION LIGHTS

**FOR USE ON SAIL OR POWER DRIVEN VESSELS UNDER 20 METERS (65.6 FT.) IN LENGTH.**

**BASE MOUNT. BLACK PLASTIC.  
COMPLETE WITH 12, 24 OR 32 VOLT BULB.**



Height Overall Inches	O.D. Base Inches	Height Lens Inches	Screw Size	Weight Ounces
4-7/8	3-5/16	2-3/4	10	9-1/2

### ORDERING INFORMATION - FOR 12 VOLT LIGHTS

Description	Visibility Arc	Display Pkg. - 5 Cards 1 Pc. per Card	Std. Pkg. - 1 Pc. OEM Pkg. - 10 Pcs.	Visibility Miles	Replacement Bulb
Bi-Color Light	225°	200 BB DP1	200 BB 12V	2	375 12V 25W
Red Side Light	112-1/2°	200 PB DP1	200 PB 12V	2	375 12V 25W
Green Side Light	112-1/2°	200 SDB DP1	200 SDB 12V	2	375 12V 25W
White Masthead Light	225°	200 MB DP1	200 MB 12V	3	375 12V 25W
White Stern Light	135°	200 SNB DP1	200 SNB 12V	2	375 12V 10W
Yellow Towing Light	135°	200 TWB DP1	200 TWB 12V	2	375 12V 10W
White All-Round Light	360°	200 SWB DP1	200 SWB 12V	2	375 12V 10W
Red All-Round Light	360°	200 SRB DP1	200 SRB 12V	2	375 12V 25W
Green All-Round Light	360°	200 SGB DP1	200 SGB 12V	2	375 12V 25W
Tri-Color Light*	360°	200 TB DP1	200 TB 12V	2	375 12V 25W

\*For Use on Vessels Under Sail Alone.

### ORDERING INFORMATION - FOR 24 VOLT LIGHTS

Replace the "DP1" with "DP2" For Display Package or the "12V" with "24V" For Standard Package or OEM Package (e.g., 200 BB DP2 or 200 BB 24V). For the Replacement Bulb, Replace the "12V" with "24V" (e.g., 375 24V 25W and 375 24V 10W).

### ORDERING INFORMATION - FOR 32 VOLT LIGHTS

Replace the "DP1" with "DP3" For Display Package or the "12V" with "32V" For Standard Package or OEM Package (e.g., 200 BB DP3 or 200 BB 32V). For the Replacement Bulb, Replace the "12V" with "32V" (e.g., 375 32V 25W and 375 32V 10W).



**FIG. 200 SNB**



**FIG. 200 TWB**

### FIG. 200 SERIES BASE MOUNT



**FIG. 200 SGB**



**FIG. 200 BB**



**FIG. 200 SRB**

### SPARE PARTS ORDERING INFORMATION

Spare Lens Assembly Part Numbers are Determined by Replacing the Last Three Digits of the Catalog Number with the Letters "LNS" (e.g., 200 BB LNS, for a Bi-Color Base Mount Lens Assembly).

Spare Replacement Bulb Socket, Cat No. 93



## ALL-ROUND NAVIGATION LIGHTS

FOR USE ON SAIL OR POWER DRIVEN VESSELS UNDER 20 METERS (65.6 FT.) IN LENGTH.

**HALYARD MOUNT - BLACK PLASTIC WITH STAINLESS STEEL MOUNTING HARDWARE.**

**BASE MOUNT - BLACK PLASTIC.**

**COMPLETE WITH 12, 24 OR 32 VOLT BULB.**

Description	Height Overall Inches	O.D. Base Inches	Height Lens Inches	Screw Size	Weight Ounces
Halyard	7-1/8	3-5/16	2-3/4	---	9
Base Mount	8-5/8	3-5/16	2-3/4	10	14



### ORDERING INFORMATION - FOR 12 VOLT LIGHTS

#### HALYARD MOUNT

Description	Display Pkg. - 5 Cards 1 Pc. per Card	Std. Pkg. - 1 Pc. OEM Pkg. - 10 Pcs.	Visibility Miles	Replacement Bulb
White All-Round Light	200 SWH DP1	200 SWH 12V	2	375 12V 10W
Red All-Round Light	200 SRH DP1	200 SRH 12V	2	375 12V 25W
Green All-Round Light	200 SGH DP1	200 SGH 12V	2	375 12V 25W

#### Base Mount

Tri-Color/White All-Round Light*	200 TAB DP1	200 TAB 12V	2/2	375 12V 25W/10W
Masthead/White All-Round Light	200 MAB DP1	200 MAB 12V	3/2	375 12V 25W/10W
Green/Red All-Round Light	200 GRB DP1	200 GRB 12V	2/2	375 12V 25W/25W

### ORDERING INFORMATION - FOR 24 VOLT LIGHTS

Replace the "DP1" with "DP2" For Display Package or the "12V" with "24V" For Standard Package or OEM Package (e.g., 200 SRH DP2 or 200 SRH 24V). For the Replacement Bulb, Replace the "12V" with "24V" (e.g., 375 24V 25W).

### ORDERING INFORMATION - FOR 32 VOLT LIGHTS

Replace the "DP1" with "DP3" For Display Package or the "12V" with "32V" For Standard Package or OEM Package (e.g., 200 GRB DP3 or 200 GRB 32V). For the Replacement Bulb, Replace the "12V" with "32V" (e.g., 375 32V 25W and 375 32V 10W).



Fig. 200 SRH



Fig. 200 GRB

#### SPARE PARTS ORDERING INFORMATION

Spare Lens Assembly Part Numbers are Determined by Replacing the Last Three Digits of the Catalog Number with the Letters "LNS" (e.g., 200 SRH LNS, for a Red Halyard Mount Lens Assembly) or (e.g., 200 GRB LNS, for a Green/Red All-Round Lens).

Spare Replacement Bulb Sockets: (single and lower for double) Cat. No. 93, (upper for double), Cat No. 95.

### FIG. 222 - PIPE MOUNTING BRACKET

**CAST ZINC WITH GLOSS BLACK PERKO•KOTE FINISH  
COMPLETE WITH SCREWS AND SOFT BLACK MOUNTING GASKET  
FOR MOUNTING BRACKET TO LIGHT.**

For Use on All 200 Series Base Mount Lights.

#### ORDERING INFORMATION

O.D. Overall Inches	Tapped Pipe Size Inches	Display Pkg. - 5 bags 1 Pc. per bag
3-5/16	1/2	222 DP BLK



Fig. 222





## NAVIGATION LIGHTS

FOR USE ON SAIL OR POWER DRIVEN VESSELS UNDER 20 METERS (65.6 FT.) IN LENGTH.

**CAST ZINC WITH GLOSS BLACK PERKO•KOTE FINISH  
FOR 12 OR 32 VOLTS, BULB NOT INCLUDED.**



Fig.	Height Overall Inches	Height Lens Inches	Tapped Pipe Size	Screw Size	Weight Pounds
108	6	5	1/2"	10	1-3/4
All Others	5-1/4	4-1/4	----	10	2

### ORDERING INFORMATION

Description	Visibility Arc	Display Pkg. - 5 Cards 1 Pc. per Card	Standard Pkg. - 1 Pc.	Visibility Miles
Side Lights (Pair)	112-1/2°	109 DP BLK	109 000 BLK	2
Red Side Light	112-1/2°	109 DPR BLK	109 R00 BLK	2
Green Side Light	112-1/2°	109 DPG BLK	109 G00 BLK	2
White Masthead Light	225°	110 DP BLK	110 000 BLK	3
White Stern Light	135°	111 DP BLK	111 000 BLK	2
Yellow Towing Light	135°	111 DPM BLK	111 M00 BLK	2
White All-Round Light**	360°	108 DP BLK	108 000 BLK	2
Red All-Round Light	360°	108 DPR BLK	108 R00 BLK	2
Green All-Round Light	360°	108 DPG BLK	108 G00 BLK	2

\*Base Removable for Flush Mounting.

\*\*This Light is Supplied with a Gray Tinted Globe.



Fig. 109



Fig. 110



Fig. 108



Fig. 111



Fig. 109

### SPARE PARTS ORDERING INFORMATION

#### Spare Lenses:

112-1/2° Fig. No. 259 H02, Specify Color.  
135° Fig. No. 269 H02, Specify Color.  
225° Cat. No. 256 H02 WHT.  
360° Fig. No. 106 000, Specify Color.

#### Required Bulbs:

For 12 Volts (2 per card), Cat. No. 70 DP1 CLR.  
For 32 Volts (2 per card), Cat. No. 70 DP2 CLR.  
Spare Base and Gasket for Fig. No. 108, Cat. No. 222 DP BLK.

## MEAL AND ABSENT LIGHT - FIG. 329

**CHROME PLATED BRONZE.**

**DOUBLE CONTACT BAYONET SOCKETS, BULBS NOT INCLUDED.**

Blue Owner Absent Light and White Mealtime Light,  
Replace Blue and White Flags for Use at Night.  
For Mounting on Main Starboard Yardarm.



Fig. 329

### ORDERING INFORMATION

Dimensions Base Inches	Length Overall Inches	O.D. Globe Inches	Standard Pkg. - 1 pc.	Screw Size	Weight Pounds
3-3/8 x 1-3/4	9	2-1/2	329 000 CHR	8	2

### SPARE PARTS ORDERING INFORMATION

Required Bulbs (2 per card) For 12 Volt Use, Cat. No. 337 011 DP.  
Required Bulbs (1 per card) For 32 Volt Use, Cat. No. 337 018 DP.  
Spare Socket, Cat. No. 24 DP1.

Spare Blue Globe, Cat. No. 250 000 BLU.  
Spare White Globe, Cat. No. 250 000 WHT.



## NAVIGATION LIGHTS

**FOR USE ON POWER DRIVEN VESSELS UNDER 20 METERS (65.6 FT) IN LENGTH.**

**SHEET METAL, GALVANIZED STEEL OR POLISHED BRASS.  
BOTTOM OPENING, COMPLETE WITH MOUNTING BRACKET,  
FOR 12 OR 32 VOLTS, BULB NOT INCLUDED.**

Height Overall Inches	Height Lens Inches	Screw Size	Weight Pounds
6	5-1/8	6	2

### ORDERING INFORMATION

For Vessels 12 Meters (39.4 ft.) to 20 Meters (65.6 ft.) in Length (12 or 32 Volts Only).

Description	Visibility Arc	Galvanized Steel	Polished Brass	Visibility Miles
Side Lights (Pair)	112-1/2°	91 F03 GAL	91 F03 POL	2
Red Side Light	112-1/2°	91 RF3 GAL	91 RF3 POL	2
Green Side Light	112-1/2°	91 GF3 GAL	91 GF3 POL	2
White Masthead Light	225°	98 F03 GAL	98 F03 POL	3
White Stern Light	135°	99 F03 GAL	99 F03 POL	2



**FIG. 98**



**FIG. 99**



**FIG. 91**

### SPARE PARTS ORDERING INFORMATION

#### Spare Lenses:

112-1/2° Fig. No. 259 CL3, Specify Color.  
135° Fig. No. 269 CL3, Specify Color.  
225° Cat. No. 256 CL3 Specify Color.  
Spare Mounting Bracket, Cat. No. 92 000 GAL or PLB.  
Spare Electric Adapter, Cat. No. 138 F03.

#### Required Bulbs:

Bulbs for 12 volts (2 per card), Cat. No. 70 DP1 CLR.  
Bulbs for 32 volts (2 per card), Cat. No. 70 DP2 CLR.



## NAVIGATION LIGHTS

FOR USE ON POWER DRIVEN VESSELS AS SPECIFIED BELOW.

**SHEET METAL, GALVANIZED STEEL OR POLISHED BRASS.  
BOTTOM OPENING, COMPLETE WITH MOUNTING BRACKET,  
FOR 12 OR 32 VOLTS, BULB NOT INCLUDED.**

	Height Overall Inches	Height Lens Inches	Screw Size	Weight Pounds
For Vessels Under 12 Meters (39.4 ft.)	7-1/4	4-1/4	10	2-1/2
For Vessels 12 to 20 Meters (65.6 ft.)	8-1/2	5-1/8	10	3-1/2

### ORDERING INFORMATION

For Vessels Under 12 Meters (39.4 ft.) in Length (12 Volts Only).

Description	Visibility Arc	Galvanized Steel	Polished Brass	Visibility Miles
Side Lights (Pair)	112-1/2°	4 F02 GAL	4 F02 POL	1
Red Side Light	112-1/2°	4 RF2 GAL	4 RF2 POL	1
Green Side Light	112-1/2°	4 GF2 GAL	4 GF2 POL	1
White Masthead Light	225°	5 F02 GAL	5 F02 POL	2
White Stern Light	135°	7 F02 GAL	7 F02 POL	2

### ORDERING INFORMATION

For Vessels 12 Meters (39.4 ft.) to 20 Meters (65.6 ft.) in Length (12 or 32 Volts Only).

Description	Visibility Arc	Galvanized Steel	Polished Brass	Visibility Miles
Side Lights (Pair)	112-1/2°	4 F03 GAL	4 F03 POL	2
Red Side Light	112-1/2°	4 RF3 GAL	4 RF3 POL	2
Green Side Light	112-1/2°	4 GF3 GAL	4 GF3 POL	2
White Masthead Light	225°	5 F03 GAL	5 F03 POL	3
White Stern Light	135°	7 F03 GAL	7 F03 POL	2
Yellow Towing Light	135°	7 MF3 GAL	7 MF3 POL	2



FIG. 7MF



FIG. 7F



FIG. 4F



FIG. 5F & 5MF

### SPARE PARTS ORDERING INFORMATION

#### Spare Lenses:

112-1/2° Fig. No. 259 CL2 or CL3, Specify Color.

135° Fig. No. 269 CL2 or CL3, Specify Color.

225° Cat. No. 256 CL2 WHT or 256 CL3 WHT.

Spare Mounting Bracket, Cat. No. 131 000 GAL or PLB.

Spare Electric Adapter for No. 2, Cat. No. 290 F02.

Spare Electric Adapter for No. 3, Cat. No. 290 F03.

#### Required Bulbs:

Bulbs for No. 2 (12 volts-2 per card), Cat. No. 70 DP0 CLR.

Bulbs for No. 3 (12 volts-2 per card), Cat. No. 70 DP1 CLR.

Bulbs for No. 3 (32 volts-2 per card), Cat. No. 70 DP2 CLR.



## SPARE BASES FOR POLE LIGHTS

### FIG. 1045, 1059-P & 1060-P - PLUG-IN TYPE, WATERPROOF SNAP-ON COVER

**FIG. 1045 P00 - FITS FIGS. 940, 970, 1211\*, 1612 & 1631 SERIES**

**FIG. 1059 P00 - FITS FIGS. 1330 & 1630 SERIES**

**FIG. 1060 P00 - FITS FIGS. 1212\* & 1430 SERIES**

Locking Collar is Included with Base To Allow Interchangeability with Discontinued Style Bases.

**chromalex®**

#### ORDERING INFORMATION

Length Overall Inches	Width Overall Inches	Insert Type	Replaces Cat. No.	Display Pkg. - 5 Cards 1 Pc. per Card	Tube Angle Degrees
2-1/4 O.D.	----	None	1023 P00 CHR	1045 P00 DP	0
3-3/4	1-5/8	None	1330 000 99A	1059 P00 DP	16
3-3/4	1-5/8	None	1026 P00 CHR	1059 P00 DP	16
3-3/4	1-3/4	Black	1027 PB0 CHR	1060 PB0 DP	5
3-3/4	1-3/4	Teak**	1027 PT0 CHR	1060 PB0 DP	5

\*Specify 3-Contact Base (e.g., 1045 300 DP for Fig. No. 1211 or 1060 3B0 DP for Fig. No. 1212).

\*\*Teak Insert Bases No Longer Available, Substitute Black Insert Bases.

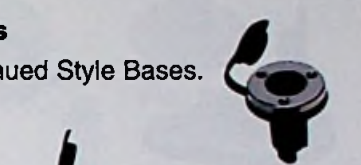

**FIG. 1045 P00**



**FIG. 1059 P00**



**FIG. 1060 P00**

### FIG. 1059-T & 1060-T - TELESCOPING TYPE

**FIG. 1059 T00 - FITS FIG. 1311 & 1611 SERIES**

**FIG. 1060 TB0 - FITS FIG. 1411 SERIES**

Locking Collar is Included with Base To Allow Interchangeability with Discontinued Style Bases.

**chromalex®**

#### ORDERING INFORMATION

Length Overall Inches	Width Overall Inches	Insert Type	Replaces Cat. No.	Display Pkg. - 5 Cards 1 Pc. per Card	Tube Angle Degrees
3-3/4	1-5/8	None	1156 000 CHR	1059 T00 DP	16
3-3/4	1-5/8	None	1026 T00 CHR	1059 T00 DP	16
3-3/4	1-3/4	Black	1027 TB0 CHR	1060 TB0 DP	5
3-3/4	1-3/4	Teak	1027 TT0 CHR	1060 TB0 DP	5



**FIG. 1059 T00**



**FIG. 1060 TB0**

### FIG. 1046 & 1047 - PLUG-IN TYPE, WATER RESISTANT SLIDE COVER

**FIG. 1046 P00 - FITS FIG. 1640 SERIES**

**FIG. 1047 P00 - FITS FIG. 1296 & 1660 SERIES**

**chromalex®**

#### ORDERING INFORMATION

Length Overall Inches	Width Overall Inches	Display Pkg. - 5 Cards 1 Pc. per Card	Tube Angle Degrees
3-1/2	1-1/2	1047 P00 DP	0
3-1/2	1-1/2	1046 P00 DP	5

\*Specify 3-Contact Base, Cat. No. 1047 3B0 DP.



**FIG. 1046**

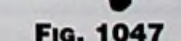

**FIG. 1047**

### FIG. 1125-99A & 1209-99A - PLUG-IN TYPE, WATERPROOF SCREW-ON CAP

**FIG. 1125-99A - FITS FIG. 1125**

**FIG. 1209-99A - FITS FIG. 1209 SERIES**

**chromalex®**

#### ORDERING INFORMATION

Length Overall Inches	Width Overall Inches	Display Pkg. - 5 Cards 1 Pc. per Card	Tube Angle Degrees
3-3/8	2-1/4	1125 DP 99A	16
3-3/8	2-1/4	1209 DP 99A	16



**FIG. 1125-99A & 1209-99A**



## SPARE BASES CONT. & BRACKETS FOR WINDSHIELD MOUNT LIGHTS



**FIG. 1048 - PLUG-IN TYPE WITH WATERPROOF SNAP-ON COVER**  
**FITS FIGS. 1335 & 1620**



**Fig. 1048**



**chromalex®**

**ORDERING INFORMATION**

Length Overall Inches	Width Overall Inches	Display Pkg. - 5 Cards 1 Pc. per Card	Tube Angle Degrees
3-1/2	1-7/8	1048 P00 DP	5



**FIGS. 1052A & 1054A - FOLD-DOWN, ADJUSTABLE ANGLE WITH PLASTIC ADAPTERS FOR "V" OR FLAT MOUNT, CONTAINS NOTCH FOR THROUGH BASE WIRING**



**Fig. 1052A**



**Fig. 1054A**

**FIG. 1052A - HORIZONTAL MOUNT, FITS FIG. 1181**  
**FIG. 1054A - VERTICAL MOUNT, FITS FIG. 1184**

Complete with Knob and End Plug.

**chromalex®**

**ORDERING INFORMATION**

Length Overall Inches	Width Overall Inches	Replaces Cat. No.	Display Pkg. - 5 Cards 1 Pc. per Card
2 2-1/4	1-1/2 5/8	1120 000 CHR 1122 000 CHR	1052 DPA CHR 1054 DPA CHR



**FIGS. 1052 & 1054 - FOLD-DOWN, ADJUSTABLE ANGLE WITH PLASTIC ADAPTERS FOR "V" OR FLAT MOUNT**



**Fig. 1052**



**Fig. 1054**

**FIG. 1052 - HORIZONTAL MOUNT, FITS FIG. 1134**  
**FIG. 1054 - VERTICAL MOUNT, FITS FIG. 1137**

Complete with Knob and End Plug.

**chromalex®**

**ORDERING INFORMATION**

Length Overall Inches	Width Overall Inches	Replaces Cat. No.	Display Pkg. - 5 Cards 1 Pc. per Card
2 2-1/4	1-1/2 5/8	1120 000 CHR 1122 000 CHR	1052 DP CHR 1054 DP CHR



**FIGS. 1123-99A & 1124-99A - PLUG-IN TYPE, WATERPROOF SCREW-ON CAP WITH PLASTIC ADAPTERS FOR "V" OR FLAT MOUNT**



**Fig. 1123-99A**



**Fig. 1124-99A**

**FIG. 1123 - HORIZONTAL MOUNT, FITS FIG. 1123 SERIES**  
**FIG. 1124 - VERTICAL MOUNT, FITS FIG. 1124 SERIES**

**chromalex®**

**ORDERING INFORMATION**

Dimensions Bracket Inches	Display Pkg. - 5 Cards 1 Pc. per Card
2-1/4 x 3/4 3/4 x 2-1/4	1123 DP 99A 1124 DP 99A



## SPARE PARTS

FOR NAVIGATION LIGHTS ON VESSELS UNDER 20 METERS (65.6 FT.) IN LENGTH

### FIGS. 138, 290, 291 & 292 - ELECTRIC ADAPTERS

FIGS. 138 & 290 - BRASS SPRING TYPE FOR DOUBLE ENDED BULBS

FIG. 291 - FOR DOUBLE CONTACT BAYONET BASE BULB

FIG. 292 - FOR MEDIUM SCREW BASE BULB

#### ORDERING INFORMATION

O.D. Overall Inches	I.D. Light Opening Inches	Height Overall Inches	Standard Pkg. - 1 Pc.
2-3/16	1-7/8	3-3/4	138 F03
4-1/2	3-3/16	4-3/4	290 F02
4-1/2	3-3/16	5-1/4	290 F03
3-5/8	3-3/16	2-5/8	291 003 PLB
3-5/8	3-3/16	2-1/8	292 000 PLB



FIG. 291



FIG. 292



FIG. 138



FIG. 290

### FIGS. 52 & 276 - DOUBLE CONTACT BAYONET SOCKETS

BRASS, WITH 6 INCH WIRE LEADS - FIG. 276 TAPPED FOR 1/8 INCH PIPE.

#### ORDERING INFORMATION

Length Overall Inches	Standard Pkg. - 5 Pcs.	Display Pkg. - 10 Bags 1 Pc. per Bag
1	-----	52 DP
1-1/2	276 000	
2	276 002	
2-3/8	276 003	
3	276 004	



FIG. 52

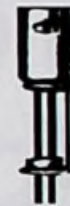

FIG. 276



### FIG. 24 - DOUBLE CONTACT BAYONET SOCKET

BLACK PLASTIC BODY

#### ORDERING INFORMATION

Length Pigtail Inches	O.D. Inches	Display Pkg. - 10 Bags 1 Pc. per Bag
10	3/4	24 DP1
60	3/4	24 DP2



FIG. 24



### FIG. 1109 - SINGLE CONTACT BAYONET SOCKET - BRASS

#### ORDERING INFORMATION

Length Pigtail Inches	Length Socket Inches	O.D. Inches	Display Pkg. - 10 Bags 1 Pc. per Bag
6	5/8	3/8	1109 DP



FIG. 1109



### FIG. 286 - OIL FOUNT - BRASS

#### ORDERING INFORMATION

O.D. Overall Inches	I.D. Light Opening Inches	Standard Pkg. - 1 Pc.
3-5/8	3-3/16	286 000 PLB



FIG. 286

### FIGS. 231, 246 & 302 - OIL BURNERS AND WICKS - BRASS

#### ORDERING INFORMATION

O.D. Thread Inches	Plain Standard Pkg. - 5 Pcs.	Chrome Standard Pkg. - 5 pPcs.	Width Wick Inches	Wick Standard Pkg. - 20 Pcs.
13/16	231 000 PLB	231 000 CHR	3/8	302 00A
13/16	246 000 PLB	-----	3/8	302 00A



FIG. 231



FIG. 246



FIG. 302



### FIG. 230 - LAMP CHIMNEY - GLASS

#### ORDERING INFORMATION

O.D. Base Inches	Height Overall Inches	Standard Pkg. - 5 Pcs.
1-1/2	4-3/4	230 000 CLR



FIG. 230



## SPARE PARTS

FOR NAVIGATION LIGHTS ON VESSELS UNDER 20 METERS (65.6 FT.) IN LENGTH



### FIG. 337 - DOUBLE CONTACT BAYONET BASE BULB

#### ORDERING INFORMATION



Fig. 337



Nominal Voltage	Wattage	Amps	Display Pkg. 5 cards	Bulbs per card	Bulb Diameter Inches	Mfr. Lamp No.
12	7	.58	337 011 DP	2	3/4	90
12	11	.94	337 012 DP	2	3/4	1004
12	17	1.44	337 013 DP	2	1	1142
24	15	.63	337 014 DP	1	1	306
32	12	.37	337 018 DP	1	3/4	624
32	14	.45	337 019 DP	1	1	1228
32	20	.61	337 020 DP	1	1	1692
32	24	.74	337 021 DP	1	1-3/8	1054
120	15	---	337 023 DP	2	7/8	15T7

### FIG. 374 - DOUBLE CONTACT BAYONET BASE BULB

#### ORDERING INFORMATION



Fig. 374

Nominal Voltage	Wattage	Amps	Standard Pkg.- 1 bulb
12	30	2.5	374 001 CLR
24	30	1.25	374 002 CLR
32	30	.94	374 003 CLR
120	30	.25	374 004 CLR

### FIG. 375 - DOUBLE CONTACT BAYONET INDEXING BASE BULB

#### ORDERING INFORMATION



Fig. 375

Nominal Voltage	Wattage	Amps	Standard Pkg.- 1 bulb
12	10	.83	375 12V 10W
12	25	2.08	375 12V 25W
24	10	.42	375 24V 10W
24	25	1.04	375 24V 25W
32	10	.31	375 32V 10W
32	25	.78	375 32V 25W

### FIG. 340 - MEDIUM SCREW BASE BULB

#### ORDERING INFORMATION



Fig. 340



Nominal Voltage	Wattage	Amps	Standard Pkg. - 6 bulbs	Type	L.C.L. Inches	Mfr. Lamp No.
12	15	1.25	340 005 FRD	A-17	2-3/8	15-A
12	25	2.08	340 006 FRD	A-19	2-9/16	25-A
12	50	4.16	340 007 FRD	A-21	3-7/16	50-A21
32	15	.47	340 011 FRD	A-17	2-3/8	15-A
32	25	.78	*340 012 FRD	A-19	2-9/16	25-A
32	50	1.56	*340 013 FRD	A-21	3-7/16	50-A21

\*Standard Pkg. - 2 bulbs

### FIGS. 67, 69, 70, 71 & 72 FESTOON BULBS - DOUBLE ENDED

#### ORDERING INFORMATION

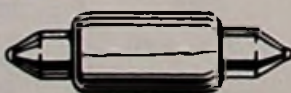

Fig. 67

Fig. 69

Fig. 70

Fig. 71

Fig. 72



Nominal Voltage	Wattage	Amps	Display Pkg. - 5 cards 2 Bulbs per card	Bulb Diameter Inches	Bulb Length Inches
12	10	.83	69 DP CLR	3/8	1-5/8
12	10	.74	70 DP0 CLR	3/8	1-11/16
12	15	.97	70 DP1 CLR	9/16	1-11/16
12	10	.80	71 DP CLR	3/8	1-1/8
24	10	.42	67 DP1 CLR	3/8	1-11/16
24	18	.75	67 DP2 CLR	9/16	1-11/16
24	10	.40	72 DP1 CLR	3/8	1-1/8
32	13	.40	70 DP2 CLR	3/8	1-5/8



## SPARE PARTS - LENSES

FOR NAVIGATION LIGHTS ON VESSELS UNDER 20 METERS (65.6 FT.) IN LENGTH

### 112-1/2° LENSES FOR BI-COLOR/TRI-COLOR LIGHTS

#### ORDERING INFORMATION

Color	Height Inches	Width Inches	Display Pkg. - 5 Cards 1 Set per Card
Red/Green	1-5/16	2-1/8	247 DP LNS*
Red/Green	1	1-3/4	283 DPA LNS*
Red/Green	1-1/4	1-3/8	296 DP LNS*
Red/Green	2-1/2	2	259 DPA LNS
Red/Green	1-1/2	1	268 DP LNS
Red/Green	1	1-3/4	289 DPA LNS*

\*One Piece Lens

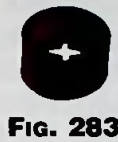

FIG. 283



FIG. 296



FIG. 268



FIG. 289



FIG. 247



FIG. 259



### 112-1/2° LENSES FOR SIDE LIGHTS

#### ORDERING INFORMATION

Color	Height Inches	Width Inches	Display Pkg. - 5 Cards 1 Pc. per Card	Std. Pkg. - 1 Pc.
Red	1-5/16	2-1/8	273 DPR LNS	.....
Green	1-5/16	2-1/8	273 DPG LNS	.....
Red	1-3/4	1-1/16	277 DPR LNS	.....
Green	1-3/4	1-1/16	277 DPG LNS	.....
Red	1	1-3/4	298 DPR LNS	.....
Green	1	1-3/4	298 DPG LNS	.....
Red/Green	1	1-9/16	281 DPA LNS*	.....
Red/Green	1-1/4	.....	260 DP LNS*	.....
Red	4-1/4	3-1/16	.....	259 CL2 RED
Green	4-1/4	3-1/16	.....	259 CL2 GRN
Red	5-1/16	3-11/16	.....	259 CL3 RED
Green	5-1/16	3-11/16	.....	259 CL3 GRN

\*Set of 1 Red and 1 Green Lens.



FIG. 259

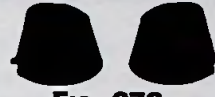

FIG. 273



FIG. 260



FIG. 298

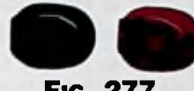

FIG. 277



FIG. 281



### 225° LENSES FOR MASTHEAD LIGHTS

#### ORDERING INFORMATION

Color	Height Inches	I.D. Inches	O.D. Inches	Display Pkg. - 5 Cards 1 Pc. per Card	Std. Pkg. - 1 Pc.
White	1	1-9/16	2-3/16	281 DPA WHT*	.....
White	1-1/2	1	1-1/4	278 DP WHT*	.....
White	4-1/4	3-3/8	.....	.....	256 CL2 WHT
White	5-1/8	3-1/4	.....	.....	256 CL3 WHT

\*Display Pkg., 5 cards - 2 Pcs. per card.



FIG. 281



FIG. 256



FIG. 278



### 135° LENSES FOR STERN LIGHTS

#### ORDERING INFORMATION

Color	Height Inches	I.D. Inches	O.D. Inches	Display Pkg. - 5 Cards 1 Pc. per Card	Std. Pkg. - 1 Pc.
White	1-1/4	1-9/16	2-3/16	74 DP WHT	.....
White	1-1/2	1	1-1/4	278 DP WHT*	.....
White	1-1/4	1-9/16	2-3/16	281 DPA WHT	.....
Clear	.....	.....	2	284 DP CLR**	.....
White	4-1/4	3-1/2	.....	.....	269 CL2 WHT
White	5-1/8	3-5/8	.....	.....	269 CL3 WHT
Yellow	4-1/4	3-1/2	.....	.....	269 CL2 YLW
Yellow	5-1/8	3-5/8	.....	.....	269 CL3 YLW

\*Display Pkg., 5 cards - 2 Pcs. per card.

\*\*Includes Gasket.



FIG. 281



FIG. 284



FIG. 74



FIG. 269



FIG. 278



### 360° LENSES FOR ALL-ROUND LIGHTS

#### ORDERING INFORMATION

Color	Height Inches	I.D. Inches	O.D. Inches	Std. Pkg. - 1 Pc.
Red	5	2-7/8	3-1/4	106 000 RED
Green	5	2-7/8	3-1/4	106 000 GRN
White	5	2-7/8	3-1/4	106 000 WHT
Yellow	5	2-7/8	3-1/4	106 000 YLW
Gray	5	2-7/8	3-1/4	106 000 GRY
White	3	1-1/2	1-9/16	201 DP WHT*
Clear	2-1/2	1-11/16	2	248 DP CLR*
Frosted	2-1/2	1-11/16	2	248 000 FRD
Clear	3-5/16	3-3/16	.....	261 JR0 CLR
Frosted	3-5/16	3-3/16	.....	261 JR0 FRD
Clear	4-1/4	4	.....	261 SR0 CLR
Frosted	4-1/4	4	.....	261 SR0 FRD

\*Display Pkg., 5 cards - 2 Pcs. per card.



FIG. 201



FIG. 248



FIG. 248F



FIG. 106



FIG. 261

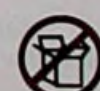



## U.S. COAST GUARD REGULATIONS

### FOR NAVIGATION LIGHTS ON VESSELS OVER 20 METERS (65.6 FT.) IN LENGTH.

On March 31, 1977, the U.S. Coast Guard published in the Federal Register, an amendment to the navigation and navigable water regulations, which added a new subchapter DD, (33CFR 87). This subchapter contains rules implementing and interpreting the International Regulations for Preventing Collisions at Sea, 1972 ('72 COLREGS). The International Regulations for Preventing Collisions at Sea, 1960, were replaced by the '72 COLREGS at 1200 hours, zone time on July 15, 1977. Therefore, all vessels on the high seas must comply with the '72 COLREGS at this time. In addition, with the enactment of the U.S. Inland Navigation Rules Act of 1980, the Inland Rules, Western Rules, and Great Lakes Rules were unified into a single set of requirements. The effective date for this legislation was December 24, 1981 (March 1, 1983 for Great Lakes). Therefore, all vessels must comply with these rules at this time.

Rules 21 and 22 of the '72 COLREGS and the U.S. Inland Navigation Rules give the color and range requirements for various navigation lights. Annex 1 to the '72 COLREGS and the U.S. Inland Navigation Rules gives positioning and technical details for these lights.

### U.S. COAST GUARD ACCEPTANCE OF NAVIGATION LIGHTS

All U.S. Registered vessels are subject to either the '72 COLREGS or the U.S. Inland Rules. The U.S. Coast Guard is accepting lights that have passed the U.L. tests (U.L. Standard 1104) as meeting the '72 COLREGS and the U.S. Inland Rules for vessels over 20 meters (65.6 ft.) in length. U.S. requirements for smaller vessels are less strict. As the first domestic manufacturer to pass U.L. 1104, PERKO's lights can be installed on vessels over 20 meters (65.6 ft.) in length. Some models are designed for use on vessels over 20 meters (65.6 ft.) in length, while others are designed for use on vessels 20 meters (65.6 ft.) to 50 meters (164.0 ft.) in length.

A brass tag is permanently affixed to the light indicating the type of light, catalog no., voltage and bulb type to install to meet the visibility requirements. It also states that the light is classified by U.L. in accordance with the '72 COLREGS. This is the only documentation needed by a vessel for navigation lights to certify light construction compliance with the '72 COLREGS and the Inland Navigation Rules, and eliminates the former "Certificate of Compliance".



### EACH LIGHT HAS ITS OWN SERIAL NO. FOR IDENTIFICATION.

The lights indicated for use on vessels over 20 meters (65.6 ft.) in length have passed U.L. 1104. The facsimile of the tag shown above is used on our cast bronze lights. Similar rectangular tags are used on other style lights.

Please note that any changes made to PERKO Navigation lights, including substitution of bulbs other than those shown in our catalog, instruction sheets, or metal tags (affixed to some lights) will void all certifications and U.S. Coast Guard acceptance.

For the present, the U.S. Coast Guard will not publish a list of U.L. classified lights. However, field offices have been notified. For more detailed information, consult the complete '72 COLREGS, the U.S. Inland Navigation Rules, and your local U.S. Coast Guard office.

### SPECIAL PURPOSE LIGHTS

Other lights (not shown) for use where the vessel is subject to special local requirements are available. Contact PERKO for further information.



## SINGLE LENS NAVIGATION LIGHTS

FOR USE ON VESSELS OVER 20 METERS (65.6 FT.) IN LENGTH.

**CAST BRONZE.**

**COMPLETE WITH A PRE-WIRED MEDIUM PREFOCUS SOCKET AND 3 FEET OF 16/3-SO CABLE THROUGH A WATERTIGHT TERMINAL TUBE. WATERTIGHT ACCESS CAP FOR REBULBING AND CLEANING. 120 VOLT BULB INCLUDED.**

Height Overall Inches	Height Lens Inches	Weight Pounds	Mounting Bolt Size Inches
9-1/4	6-3/4	11-1/8	3/8

### ORDERING INFORMATION

Description	Visibility Arc	Visibility Miles	Cat. No.
Red SideLight	112-1/2°	3	1172 RE0 PLB
Green Side Light	112-1/2°	3	1172 GE0 PLB
White Masthead Light	225°	6	1173 E00 PLB
White Stern Light*	135°	3	1174 E00 PLB
Yellow Towing Light	135°	3	1174 ME0 PLB
White All-Round Light*	360°	3	1169 E00 PLB
White All-Round Light**	360°	6	1169 HE0 PLB
Red All-Round Light	360°	3	1170 RE0 PLB
Green All-Round Light	360°	3	1170 GE0 PLB
Yellow All-Round Light	360°	3	1170 ME0 PLB

Special lights to meet local requirements are available upon request.

\*These lights are supplied with a Gray Tinted Lens.

\*\*For Great Lakes use.

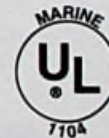
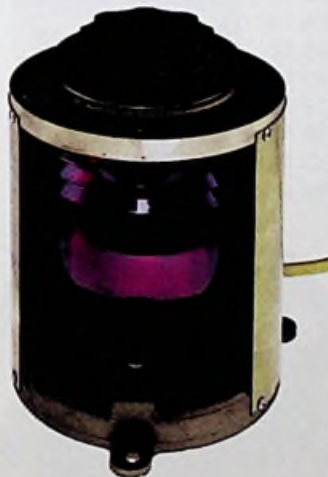

#### IMPORTANT BULB DATA

To comply with U.L. Standard 1104, the lights listed on this page must use a PERKO Cat. No. 342 004 CLR bulb.

#### SPARE PARTS ORDERING INFORMATION

##### Spare Lenses:

Red, Cat. No. 261 001 RED  
 Green, Cat. No. 261 001 GRN  
 White, Cat. No. 261 001 CLR  
 Gray, Cat. No. 261 001 GRY  
 Yellow, Cat. No. 261 001 YLW

Spare Lens Gasket, Cat. No. 1143.  
 Spare O-Ring for Cap, Cat. No. 1119.  
 Spare Medium Prefocus Socket, Cat. No. 347.  
 Spare Lens Retaining Clip with Bolt, Cat. No. 1133.  
 Spare Access Cap, O-Ring and Retainer, Cat. No. 1105 000 BLK.



## DOUBLE LENS NAVIGATION LIGHTS

FOR USE ON VESSELS OVER 20 METERS (65.6 FT.) IN LENGTH.

**CAST BRONZE.**

**EACH COMPARTMENT CONTAINS A PRE-WIRED MEDIUM PREFOCUS SOCKET WITH 3 FEET OF 16/3-SO CABLE THROUGH A WATERTIGHT TERMINAL TUBE. WATERTIGHT ACCESS CAP FOR REBULBING AND CLEANING. 120 VOLT BULBS INCLUDED.**

Height Overall Inches	Height Lens Inches	Weight Pounds	Mounting Bolt Size Inches
17-1/4	6-3/4	22-5/8	3/8

### ORDERING INFORMATION

Description	Visibility Arc	Visibility Miles	Cat. No.
Red Side Light	112-1/2°	3	1164 RE0 PLB
Green Side Light	112-1/2°	3	1164 GE0 PLB
White Masthead Light	225°	6	1165 E00 PLB
White Stern Light*	135°	3	1166 E00 PLB
Yellow Towing Light	135°	3	1166 ME0 PLB
White All-Round Light*	360°	3	1167 E00 PLB
White All-Round Light**	360°	6	1167 HE0 PLB
Red All-Round Light	360°	3	1168 RE0 PLB
Green All-Round Light	360°	3	1168 GE0 PLB
Yellow All-Round Light	360°	3	1168 ME0 PLB

Special lights to meet local requirements are available upon request.

\*These lights are supplied with a Gray Tinted Lens.

\*\*For Great Lakes use.



### IMPORTANT BULB DATA

To comply with U.L. Standard 1104, the lights listed on this page must use a PERKO Cat. No. 342 004 CLR bulb.

### Spare Lenses:

Red, Cat. No. 261 001 RED  
Green, Cat. No. 261 001 GRN  
White, Cat. No. 261 001 CLR  
Gray, Cat. No. 261 001 GRY  
Yellow, Cat. No. 261 001 YLW

### SPARE PARTS ORDERING INFORMATION

Spare Lens Gasket, Cat. No. 1143.  
Spare O-Ring for Cap, Cat. No. 1119.  
Spare Dual Medium Prefocus Socket Assembly, Cat. No. 303.  
Spare Lens Retaining Clip with Bolt, Cat. No. 1133.  
Spare Plastic Cap, O-Ring and Retainer, Cat. No. 1105 000 BLK.



## NAVIGATION LIGHTS

FOR USE ON VESSEL LENGTHS AS SPECIFIED BELOW.

**SHEET METAL, GALVANIZED STEEL\*, PLAIN OR POLISHED BRASS.**  
**COMPLETE WITH A MEDIUM PREFOCUS SOCKET AND A WATERTIGHT TERMINAL TUBE**  
**FOR 16/3-SO CABLE. WATERTIGHT ACCESS CAP FOR REBULBING AND CLEANING.**  
**120 VOLT BULB NOT INCLUDED.**

Size No.	Height Overall Inches	Height Lens Inches	Weight Pounds
1	11-1/2	6-3/4	6-5/8
2	13-1/2	7-1/2	10-7/8

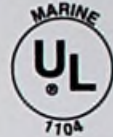

### ORDERING INFORMATION

FOR USE ON VESSELS 20 METERS (65.6 FT.) TO 50 METERS (164.0 FT.) IN LENGTH.

Description	Galvanized Steel*	Plain Brass	Polished Brass	Visibility Arc	Visibility Miles	Required Bulb
Red Side Light	1150 RE1 GAL	1150 RE1 PLB	1150 RE1 POL	112-1/2°	2	342 002 CLR
Green Side Light	1150 GE1 GAL	1150 GE1 PLB	1150 GE1 POL	112-1/2°	2	342 002 CLR
White Masthead Light	1151 E01 GAL	1151 E01 PLB	1151 E01 POL	225°	5	342 003 CLR
White Stern Light	1152 E01 GAL	1152 E01 PLB	1152 E01 POL	135°	2	342 000 CLR
Yellow Towing Light	1152 ME1 GAL	1152 ME1 PLB	1152 ME1 POL	135°	2	342 000 CLR
White All-Round Light	1153 E01 GAL	1153 E01 PLB	1153 E01 POL	360°	2	342 001 CLR
Red All-Round Light	1154 RE1 GAL	1154 RE1 PLB	1154 RE1 POL	360°	2	342 004 CLR
Green All-Round Light	1154 GE1 GAL	1154 GE1 PLB	1154 GE1 POL	360°	2	342 003 CLR
Yellow All-Round Light	1154 ME1 GAL	1154 ME1 PLB	1154 ME1 POL	360°	2	342 002 CLR

### ORDERING INFORMATION

FOR USE ON VESSELS OVER 20 METERS (65.6 FT.) IN LENGTH.

Description	Galvanized Steel*	Plain Brass	Polished Brass	Visibility Arc	Visibility Miles	Required Bulb
Red Side Light	1150 RE2 GAL	1150 RE2 PLB	1150 RE2 POL	112-1/2°	3	342 004 CLR
Green Side Light	1150 GE2 GAL	1150 GE2 PLB	1150 GE2 POL	112-1/2°	3	342 004 CLR
White Masthead Light	1151 E02 GAL	1151 E02 PLB	1151 E02 POL	225°	6	342 004 CLR
White Stern Light	1152 E02 GAL	1152 E02 PLB	1152 E02 POL	135°	3	342 002 CLR
Yellow Towing Light	1152 ME2 GAL	1152 ME2 PLB	1152 ME2 POL	135°	3	342 002 CLR
White All-Round Light	1153 E02 GAL	1153 E02 PLB	1153 E02 POL	360°	3	342 003 CLR
Red All-Round Light	1154 RE2 GAL	1154 RE2 PLB	1154 RE2 POL	360°	3	342 006 CLR
Green All-Round Light	1154 GE2 GAL	1154 GE2 PLB	1154 GE2 POL	360°	3	342 004 CLR
Yellow All-Round Light	1154 ME2 GAL	1154 ME2 PLB	1154 ME2 POL	360°	3	342 003 CLR

\*Galvanized Steel Lights are Preprimed.



FIG. 1150



FIG. 1151



FIG. 1152



FIG. 1153



FIG. 1154

#### IMPORTANT BULB DATA

To comply with U.L. Standard 1104, the lights listed on this page must use a PERKO Cat. No. 342 bulb.

#### SPARE PARTS ORDERING INFORMATION

##### Spare Lenses:

112-1/2°	Cat. No. 259 No. 1 or 2, Specify Color
135°	Cat. No. 269 No. 1 or 2, Specify Color
225°	Cat. No. 256 No. 1 or 2, Specify Color
360°	Cat. No. 261F No. 1 or 2, Specify Color

Spare Medium Prefocus Socket, Cat. No. 347 A00.
Spare Access Cap, O-Ring and Retainer, Cat. No. 1105 000 BLK.
Spare O-Ring for Cap, Cat. No. 1119.
Spare Socket Supports, Cat. Nos. 341 001 PLB & 341 01A PLB.



## NAVIGATION LIGHTS

FOR USE ON VESSELS 20 METERS (65.6 FT.) TO 50 METERS (164.0 FT.) IN LENGTH.

**BLACK PLASTIC.  
COMPLETE WITH PRE-WIRED DOUBLE CONTACT SOCKET AND  
3 FEET OF 16/3-SO CABLE FOR 12, 24, 32 OR 120 VOLTS.  
WATERTIGHT ACCESS CAP FOR REBULBING AND CLEANING.  
BULB NOT INCLUDED.**

Height Overall Inches	Height Lens Inches	Screw Size	Weight Pounds
7-1/2	4-1/2	1/4	3-1/8

### ORDERING INFORMATION

Description	Visibility Arc	Visibility Miles	Cat. No.
Red Side Light	112-1/2°	2	1127 RA0 BLK
Green Side Light	112-1/2°	2	1127 GA0 BLK
White Masthead Light	225°	5	1128 A00 BLK
White Stern Light*	135°	2	1129 A00 BLK
Yellow Towing Light	135°	2	1129 MA0 BLK
White All-Round Light*	360°	2	1130 A00 BLK
White All-Round Light**	360°	5	1130 HA0 BLK
Red All-Round Light	360°	2	1130 RA0 BLK
Green All-Round Light	360°	2	1130 GA0 BLK
Yellow All-Round Light	360°	2	1130 MA0 BLK



\*These lights are supplied with a Gray Tinted Lens.

\*\*For Great Lakes use.



**FIG. 1127  
RED & GREEN  
SIDE LIGHTS  
112-1/2 DEGREES**



**FIG. 1128  
MASTHEAD LIGHTS  
225 DEGREES**



**FIG. 1129  
STERN OR  
TOWING LIGHTS  
135 DEGREES**



**FIG. 1130  
ALL-ROUND  
LIGHTS  
360 DEGREES**

#### IMPORTANT BULB DATA

To comply with U.L. Standard 1104, the lights listed on this page must use a PERKO Cat. No. 374 bulb.

#### SPARE PARTS ORDERING INFORMATION

##### Spare Lens Assemblies:

Red, Cat. No. 249 000 RED.  
Green, Cat. No. 249 000 GRN.  
White, Cat. No. 249 000 CLR.  
Gray, Cat. No. 249 000 GRY.  
Yellow, Cat. No. 249 000 YLW.

Spare Double Contact Socket, Cat. No. 134.  
Spare Access Cap, O-Ring and Retainer,  
Cat. No. 1105 000 BLK.  
Spare O-Ring for Cap, Cat. No. 1119.

##### Required Bulbs:

12 Volts, Cat. No. 374 001 CLR.  
24 Volts, Cat. No. 374 002 CLR.  
32 Volts, Cat. No. 374 003 CLR.  
120 Volts, Cat. No. 374 004 CLR.



## NAVIGATION LIGHTS

FOR USE ON VESSELS 20 METERS (65.6 FT.) TO 50 METERS (164.0 FT.) IN LENGTH.

**SHEET METAL, GALVANIZED STEEL\*, POLISHED OR CHROME PLATED BRASS.  
BOTTOM OPENING, COMPLETE WITH MOUNTING BRACKET  
AND SINGLE CONTACT PREFOCUS SOCKET  
FOR 12 VOLT USE ONLY. BULB NOT INCLUDED.**

Height Overall Inches	Height Lens Inches	Weight Pounds
8-1/2	5-3/16	3-1/8

### ORDERING INFORMATION

Description	Galvanized Steel	Polished Brass	Chrome Plated Brass	Visibility Arc	Visibility Miles	Required Bulb
Red Side Light	4 RD3 GAL	4 RD3 POL	4 RD3 CHR	112-1/2°	2	373 003 CLR
Green Side Light	4 GD3 GAL	4 GD3 POL	4 GD3 CHR	112-1/2°	2	373 002 CLR
White Masthead Light	5 D03 GAL	5 D03 POL	5 D03 CHR	225°	5	373 005 CLR
White Stern Light	7 D03 GAL	7 D03 POL	7 D03 CHR	135°	2	373 001 CLR
Yellow Towing Light	7 MD3 GAL	7 MD3 POL	7 MD3 CHR	135°	2	373 002 CLR

\*Galvanized Steel Lights are Preprimed.



FIG. 4



FIG. 5



FIG. 7 & 7M

#### IMPORTANT BULB DATA

To comply with U.L. Standard 1104, the lights listed on this page must use a PERKO Cat. No. 373 bulb.

#### SPARE PARTS ORDERING INFORMATION

##### Spare Lenses:

Red,	112-1/2°	Cat. No. 259 CL3 RED.
Green,	112-1/2°	Cat. No. 259 CL3 GRN.
White,	135°	Cat. No. 269 CL3 WHT.
Gray,	135°	Cat. No. 269 CL3 YLW.
Yellow,	225°	Cat. No. 256 CL3 WHT.

Spare Mounting Bracket; Cat. No. 131 000 GAL or PLB.  
Spare Single Contact Prefocus Socket Assembly, Complete  
with Stand, Bottom Plate and Gasket, Cat. No. 294 003 PLB.



## All-Round Lights

FOR USE ON VESSELS OVER 20 METERS (65.6 FT.) IN LENGTH.



Fig. 403-3

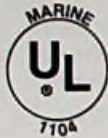

**CAST BRONZE.**  
**COMPLETE WITH MEDIUM PREFOCUS SOCKET AND 120 VOLT BULB.**

Fig. No.	Height Overall Inches	Height Lens Inches	Tapped Pipe Size Inches	Weight Pounds	Visibility Miles
403	11-1/2	6-3/4	1	8-1/4	3
412	14	6-3/4	*	8-1/4	3

### ORDERING INFORMATION

	White	Red	Green	Yellow
Fig. No. 403	403 E03 PLB**	403 RE3 PLB	403 GE3 PLB	403 ME3 PLB
Fig. No. 412	412 E00 PLB**	412 RE0 PLB	412 GE0 PLB	412 ME0 PLB

\*Supplied with watertight terminal tube for 16/3-SO cable.  
\*\*These Lights are Supplied with Gray Tinted Lenses.

### IMPORTANT BULB DATA

To comply with U.L. Standard 1104, the lights listed on this page must use a PERKO Cat. No. 342 004 CLR bulb.

### SPARE PARTS ORDERING INFORMATION

#### Spare Lenses:

Gray, Cat. No. 261 001 GRY.  
Red, Cat. No. 261 001 RED.  
Green, Cat. No. 261 001 GRN.  
Yellow, Cat. No. 261 001 YLW.

Spare Lens or Cover Gasket, Cat. No. 1143.  
Spare Medium Prefocus Socket, Cat. No. 347.



Fig. 412

FOR USE ON VESSELS 20 METERS (65.6 FT.) TO 50 METERS (164.0 FT.) IN LENGTH.

**CAST BRONZE. PLAIN OR CHROME PLATED.**  
**COMPLETE WITH DOUBLE CONTACT ELECTRICAL SOCKET FOR 12, 24, 32 OR 120 VOLTS. BULB NOT INCLUDED.**



Fig. 112A



Fig. No.	Height Overall Inches	Diameter Base Inches	Tapped Pipe Size Inches	Weight Pounds	Visibility Miles
112	8-3/4	3-1/8	----	2-1/2	2
309	6-1/2	----	1/2	2-1/4	2

### ORDERING INFORMATION

Description	Plain Bronze	Chrome Plated Bronze
White All-Round	112 A00 PLB	112 A00 CHR
Red All-Round	112 RA0 PLB	112 RA0 CHR
Green All-Round	112 GA0 PLB	112 GA0 CHR
Yellow All-Round	112 MA0 PLB	112 MA0 CHR

### ORDERING INFORMATION

Description	Plain Bronze	Chrome Plated Bronze
White All-Round	309 A00 PLB	309 A00 CHR
Red All-Round	309 RA0 PLB	309 RA0 CHR
Green All-Round	309 GA0 PLB	309 GA0 CHR
Yellow All-Round	309 MA0 PLB	309 MA0 CHR

### IMPORTANT BULB DATA

To comply with U.L. Standard 1104, the lights listed on this page must use a PERKO Cat. No. 374 bulb.

### SPARE PARTS ORDERING INFORMATION

#### Spare Lenses:

Red, Cat. No. 106 000 RED.  
Green, Cat. No. 106 000 GRN.  
White, Cat. No. 106 000 WHT.  
Yellow, Cat. No. 106 000 YLW.  
Spare Double Contact Bayonet Socket, Cat. No. 276 002.

#### Required Bulbs:

12 Volts, Cat. No. 374 001 CLR.  
24 Volts, Cat. No. 374 002 CLR.  
32 Volts, Cat. No. 374 003 CLR.  
120 Volts, Cat. No. 374 004 CLR.



Fig. 309A



## SPECIAL PURPOSE LIGHTS

### FIG. 1111ME - FOR USE ON VESSELS OF ANY LENGTH.

**SHEET METAL, GALVANIZED STEEL\* OR PLAIN BRASS. COMPLETE WITH MEDIUM PREFOCUS SOCKET AND WATERTIGHT TERMINAL TUBE FOR 16/3-SO CABLE. SEALED FLASHER UNIT, WATERTIGHT ACCESS CAP FOR REBULBING AND CLEANING. 120 VOLT BULB NOT INCLUDED.**

Designed to meet Federal Requirements for Flashing yellow 180° - 225° light for barges, canal boats, etc., that are being pushed ahead or towed along side of a tub boat. For use on 120 volts A.C. only. Federal Requirements for this light are applicable for: inland waters, the Atlantic, Pacific and Gulf coasts, intercoastal waterways and western rivers. Refer to the U.S. Inland Navigation Rules for application, configuration and technical details.

#### ORDERING INFORMATION

Galvanized Steel*	Plain Brass	Height Overall Inches	Height Lens Inches	Visibility Miles	Visibility Arc	Flashes Per Minute	Weight Pounds
1111 ME1 GAL	1111 ME1 PLB	11-1/2	6-3/4	2	225°	50-70	6-5/8

\*Galvanized Steel Lights are Preprimed.

#### IMPORTANT BULB DATA

To comply with Federal Requirements this light must use a PERKO Cat. No. 342 004 CLR bulb.

#### SPARE PARTS ORDERING INFORMATION

##### Spare Lenses:

Spare Flasher, Cat. No. 133.

Spare O-Ring for Cap, Cat. No. 1119.

Spare Lens, Cat. No. 256 001 YLW.

Spare Medium Prefocus Socket, Cat. No. 347 A00.

Spare Access Cap, O-Ring and Retainer, Cat. No. 1105 000 BLK.



FIG. 1111ME

### FIG. 1129BA - PANAMA CANAL BLUE STEERING LIGHT FOR USE ON VESSELS OF ANY LENGTH.

**BLACK PLASTIC, PRE-WIRED DOUBLE CONTACT SOCKET WITH 3 FEET OF 16/3-SJO CABLE. FOR 12, 24, 32 OR 120 VOLTS, BULB NOT INCLUDED.**

#### ORDERING INFORMATION

Cat. No.	Visibility Arc	Height Overall Inches	Height Lens Inches	Weight Pounds
1129 BAO BLK	135°	7-1/2	4-1/2	3-1/8

#### IMPORTANT BULB DATA

To comply with Panama Canal Requirements this light must use a PERKO Cat. No. 374 bulb.

#### SPARE PARTS ORDERING INFORMATION

##### Spare Lenses:

12 Volts, Cat. No. 374 001 CLR.

24 Volts, Cat. No. 374 002 CLR.

32 Volts, Cat. No. 374 003 CLR.

120 Volts, Cat. No. 374 004 CLR.

Spare Lens, Cat. No. 249 000 BLU.

Spare O-Ring for Cap, Cat. No. 1119.

Spare Double Contact Socket, Cat. No. 134.

Spare Plastic Cap, O-Ring and Retainer, Cat. No. 1105 000 BLK.



FIG. 1129BA

### FIG. 454E - ALL-ROUND WHITE WHISTLE LIGHT FOR USE ON VESSELS OVER 20 METERS (65.6 FT.) IN LENGTH.

**CAST BRONZE.**

**COMPLETE WITH MEDIUM PREFOCUS SOCKET AND 120 VOLT BULB.**

#### ORDERING INFORMATION

Cat. No.	Height Overall Inches	Height Lens Inches	Tapped Pipe Size Inches	Weight Pounds	Visibility Miles
454 E00 PLB	11-1/2	6-3/4	1	8-1/4	5

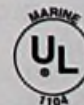

FIG. 454E

#### SPARE PARTS ORDERING INFORMATION

##### Spare Lenses:

Spare Bulb, Cat. No. 342 004 CLR.

Spare Lens, Cat. No. 261 001 CLR.

Spare Lens or Cover Gasket, Cat. No. 1143.

Spare Medium Prefocus Socket, Cat. No. 347.



## SPARE PARTS

FOR NAVIGATION LIGHTS ON VESSELS OVER 20 METERS (65.6 FT.) IN LENGTH.

### DUAL MEDIUM PREFOCUS SOCKET ASSEMBLY

Phenolic - 250 Volts - 1000 Watts  
Plug In Type - Prewired - with two medium  
prefocus sockets. For use in double lens lights.



Cat. No.	Height Overall Inches	Width Overall Inches	Weight Ounces
303	3-7/8	3-7/8	9

Male Plug Only Cat. No. 303 A00.  
Female Socket Only Cat. No. 303 B00.

### 112-1/2° LENSES



	Height Overall Inches	Diameter Opening Inches	Catalog Number
Red	6-3/4	6-1/8	259 001 RED
Green	6-3/4	6-1/8	259 001 GRN
Red	7-1/2	9-1/4	259 002 RED
Green	7-1/2	9-1/4	259 002 GRN

Weight Size 1, 8.5 oz. - Weight Size 2, 19.5 oz.

### MEDIUM PREFOCUS SOCKETS

Phenolic - 250 Volts - 1000 Watts



Cat. No.	Height Overall Inches	Diameter Overall Inches	Standard Package	Weight Per Pkg. Ounces
347	1-7/8	1-1/2	5	21-1/2
347 A00	1-7/8	1-1/2	5	21-1/2

Cat. No. 347 A00 Supplied with metal Mounting Cap  
Tapped for 3/8 Inch I.P.S.

### 135° LENSES



	Height Overall Inches	Diameter Opening Inches	Catalog Number
White	6-3/4	5-1/8	269 001 WHT
Red	6-3/4	5-1/8	269 001 RED
Yellow	6-3/4	5-1/8	269 001 YLW
White	7-1/2	7-1/4	269 002 WHT
Red	7-1/2	7-1/4	269 002 RED
Yellow	7-1/2	7-1/4	269 002 YLW

Weight Size 1, 14 oz. - Weight Size 2, 18.5 oz.

### DOUBLE CONTACT BAYONET BULBS

Clear - 12, 24, 32 or 120 Volts,  
Type T-8, C-8, Filament - 1-3/8 Inch L.C.L.



Cat. No.	Voltage	Wattage	Candella
374 001 CLR	12	30	24
374 002 CLR	24	30	24
374 003 CLR	32	30	24
374 004 CLR	120	30	24

Weight 1 oz. - Standard Pkg. - 1 pc.

### 225° LENSES



	Height Overall Inches	Diameter Opening Inches	Catalog Number
White	6-3/4	4-1/2	256 001 WHT
Red	6-3/4	4-1/2	256 001 RED
Yellow	6-3/4	4-1/2	256 001 YLW
White	7-1/2	6-5/8	256 002 WHT
Red	7-1/2	6-5/8	256 002 RED
Yellow	7-1/2	6-5/8	256 002 YLW

Weight Size 1, 18.5 oz. - Weight Size 2, 27.5 oz.

### MEDIUM PREFOCUS BULBS

Clear - 120 Volts

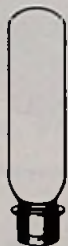

Cat. No.	Wattage
342 000 CLR	7.5
342 001 CLR**	15
342 002 CLR**	25
342 003 CLR**	40
342 004 CLR**	60
342 RS4 CLR*	60
342 006 CLR	125

Weight 1 oz. - \*Designed for rough service.  
Standard Pkg. - 1 pc. - \*\*OEM - 25 pcs.

### 360° LENSES



	Height Overall Inches	Diameter Opening Inches	Clear Cat. No.	Frosted Cat. No.
White	6-3/4	5-1/8	261 001 CLR	261 001 FRD
Red	6-3/4	5-1/8	261 001 RED	261 RF1 FRD
Green	6-3/4	5-1/8	261 001 GRN	261 GF1 FRD
Yellow	6-3/4	5-1/8	261 001 YLW	261 MF1 FRD
Gray	6-3/4	5-1/8	261 001 GRY	-----
White	7-1/2	7-3/8	261 002 CLR	261 002 FRD
Red	7-1/2	7-3/8	261 002 RED	261 RF2 FRD
Green	7-1/2	7-3/8	261 002 GRN	261 GF2 FRD
Yellow	7-1/2	7-3/8	261 002 YLW	261 MF2 FRD

Weight Size 1, 13.5 oz. - Weight Size 2, 43 oz.

### SINGLE CONTACT PREFOCUS BULBS

C-8 Filament Clear - 12 Volts



Cat. No.	Amperage	Mfg. No.
373 001 CLR	.25	25A/S8
373 002 CLR	.55	55A/S8
373 003 CLR	.77	77A/S8
373 004 CLR	1.15	1.15A/S8
373 005 CLR	2.03	2.03A/S8SCP

Weight Size 1 oz. - Standard Pkg. - 1 pc.

### 360° LENSES - With Top Assembly



	Height Overall Inches	Diameter Opening Inches	Catalog Number
White	5-3/4	5-1/2	249 000 CLR
Red	5-3/4	5-1/2	249 000 RED
Green	5-3/4	5-1/2	249 000 GRN
Yellow	5-3/4	5-1/2	249 000 YLW
Gray	5-3/4	5-1/2	249 000 GRY

Weight 17 oz.



## SEARCHLIGHTS

### FIGS. 534 & 538 - DECK CONTROL SEARCHLIGHTS

**FIG. 534 - CHROME PLATED BRASS HEAD WITH CHROME PLATED BRONZE BASE**

**FIG. 538 - CHROME PLATED BRASS HEAD WITH CHROME PLATED BRASS BASE  
FOR 12, 24 OR 32 VOLTS, 4-1/2 OR 7 INCH SEALED BEAM BULB,  
TUNGSTEN OR HALOGEN, SWITCH IN HEAD.**

#### ORDERING INFORMATION

Voltage	O.D. Bulb Inches	Approx. Range Miles	Beam Candlepower	Wattage	Height Overall Inches	Base Dimension Inches	Catalog Number	Weight Pounds
12	4-1/2	1/4	50,000	30	7-1/2	3-1/2 O.D.	538 000 CHR	1-1/2
12	4-1/2	1/3	100,000	50	7-1/2	3-1/2 O.D.	538 H00 CHR*	1-1/2
12	7	5/8	250,000	100	12-1/2	4-7/8 x 3-1/8	534 003 12V	5
24	7	3/4	470,000	450	12-1/2	4-7/8 x 3-1/8	534 003 24V	5
32	7	5/8	260,000	200	12-1/2	4-7/8 x 3-1/8	534 003 32V	5

\*NOTE: "H" in the Catalog Number Designates a Halogen Bulb.

FIG. 534



FIG. 538

### FIG. 440 - REMOVABLE DECK CONTROL SEARCHLIGHT

**CHROME PLATED BRASS HEAD WITH CHROME PLATED ZINC BASE  
FOR 12 OR 32 VOLTS, 4-1/2 OR 7 INCH SEALED BEAM BULB  
COMPLETE WITH 8 FEET OF COILED CORD, CIGARETTE LIGHTER PLUG  
AND WATERTIGHT DECK CONNECTION. SWITCH IN HEAD.**

#### ORDERING INFORMATION

Voltage	O.D. Bulb Inches	Approx. Range Miles	Beam Candlepower	Wattage	Height Overall Inches	Catalog Number	Weight Pounds
12	4-1/2	1/4	50,000	30	7-1/2	440 001 12V	2-1/4
12	4-1/2	1/3	100,000	50	7-1/2	440 H01 12V*	2-1/4
12	7	5/8	250,000	100	10	440 003 12V	3-1/2
32	7	5/8	260,000	200	10	440 003 32V	3-1/2



FIG. 440

Base Diameter, 2-1/8 Inches.

\*NOTE: "H" in the Catalog Number Designates a Halogen Bulb.

### FIG. 535 - PILOT HOUSE CONTROL SEARCHLIGHT

**CHROME PLATED BRASS HEAD WITH CHROME PLATED BRONZE BASE  
FOR 12, 24 OR 32 VOLTS, 7 INCH SEALED BEAM BULB.**

Lever Handle Controls both Horizontal and Vertical Movement.

Control Length, 7-1/2 Inches.

Maximum Ceiling Thickness, 4-1/2 Inches.

#### ORDERING INFORMATION

Voltage	Approx. Range Miles	Beam Candlepower	Wattage	Catalog Number
12	5/8	250,000	100	535 003 12V
24	3/4	470,000	450	535 003 24V
32	5/8	260,000	200	535 003 32V

Base Diameter, 4-7/8 x 3-1/8 Inches.

Weight, 5 Pounds.

FIG. 535



#### SPARE SEALED BEAM ORDERING INFORMATION

Spare 4-1/2 Inch Sealed Beam Unit, Cat. No. 433 001 12V.

Spare 4-1/2 Inch Halogen Sealed Beam Unit, Cat. No. 435 001 12V.

Spare 7 Inch Sealed Beam Unit (12 Volt), Cat. No. 433 003 12V.

Spare 7 Inch Sealed Beam Unit (24 Volt), Cat. No. 433 003 24V.

Spare 7 Inch Sealed Beam Unit (32 Volt), Cat. No. 433 003 32V.



## SEALED BEAM SEARCHLIGHTS

**BRONZE BASE, BRASS BODY.  
POLISHED CHROME PLATED OR WHITE PERKO•KOTE POWDER COATING.  
FOR 12, 24 OR 32 VOLTS.**

### Dimensions (Inches)

"A"	"B"	"C"	"D"	"G"	"H"
8	8-1/2	10	7	2	2-1/8

### Electrical Specifications

Voltage	Wattage	Approximate Candlepower	Sealed Beam Range Miles	Catalog No.
12	100	250,000	5/8	433 003 12V
24	450	470,000	3/4	433 003 24V
32	200	260,000	5/8	433 003 32V

### Figs. 305 & 313 - SEARCHLIGHT HEADS

#### ORDERING INFORMATION



**FIG. 313**

	For Lever Control Polished Chrome Cat. No.	For Lever Control White PERKO•KOTE Cat. No.	For Wheel or Lever/Gear Control Polished Chrome Cat. No.	For Wheel or Lever/Gear Control White PERKO•KOTE Cat. No.
Voltage				
12	305 H12 CHR	305 H12 WHT	313 H12 CHR	313 H12 WHT
24	305 H24 CHR	305 H24 WHT	313 H24 CHR	313 H24 WHT
32	305 H32 CHR	305 H32 WHT	313 H32 CHR	313 H32 WHT

Nominal Weight - 20 lbs.

Fig. 354 Spare Front Bezel with Glass for Figs. 305 & 313, Specify Chrome or White.  
Fig. 355 Spare Rear Cover for Figs. 305 & 313, Specify Chrome or White.

### Figs. 851, 852 & 969 - CONTROL ASSEMBLIES

#### STAINLESS STEEL TUBES WITH CHROME PLATED FITTINGS.

Control Assemblies of Different Types May Be Interchanged to Offer a Large Variety of Searchlights With a Minimum of Inventory.

Note: Lever Control (Fig. 851) Fits Fig. 305 Head Assemblies.  
Wheel Control (Fig. 852) and Lever/Gear Control (Fig. 969) Fits Fig. 313 Head Assemblies.

#### ORDERING INFORMATION

Control Length Inches	"E"	"E"	"F"	Nominal Weight Pounds
"E"	Lever Control* Cat. No.	Lever/Gear Control Cat. No.	Wheel Control Cat. No.	
8-1/2	851 000*	969 000**	852 000***	6
15-1/2	851 0A0	969 0A0	852 0A0	9
22-1/2	851 0B0	969 0B0	852 0B0	12
29-1/2	851 0C0	969 0C0	852 0C0	15

\*Maximum Ceiling Thickness, 4-1/2 Inches.

\*\*Maximum Ceiling Thickness, 3-1/2 Inches.

\*\*\*Maximum Ceiling Thickness, 3 Inches.

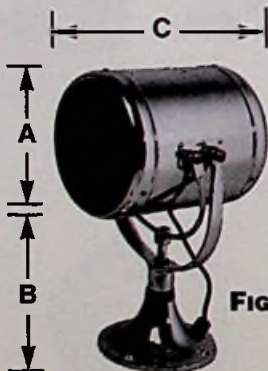

**FIG. 305**

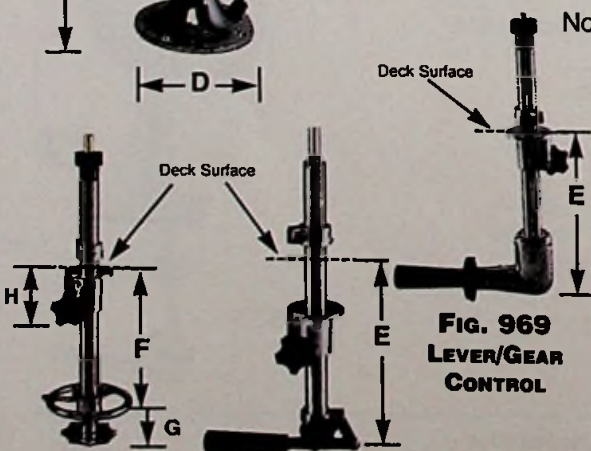

**FIG. 852  
WHEEL  
CONTROL**

**FIG. 851  
LEVER CONTROL**

**FIG. 969  
LEVER/GEAR  
CONTROL**



## SOLAR-RAY® SEARCHLIGHTS

### 800 SERIES

10", 12" OR 14"

**CAST BRONZE AND HEAVY GAUGE BRASS.  
POLISHED CHROME OR WHITE PERKO•KOTE FINISH.  
12, 24, 32, 120 OR 230 VOLTS.**

The 800 Series - Solar-Ray® Searchlights are available in 10", 12" and 14" sizes with your choice of Deck, Wheel, or Lever/Gear Controls. All models feature: halo deflectors, parabolic glass mirror reflectors for maximum light output and ventilation covers for quick dissipation of heat to help prolong bulb life. Hinged front doors have quick release stainless steel latches to provide easy access for bulb replacement. The 800 Series models are also available in our white PERKO•KOTE finish; an advanced powder coating process that eliminates the need for painting while providing a scratch resistant and chip-proof surface for painting when necessary to match the color of the vessel.

**Bulbs are not included and must be ordered separately.** PERKO offers a choice of the traditional incandescent or the brighter, more piercing quartz-halogen bulbs in a broad variety of voltages and wattages to fit every need. For complete information on bulbs and candlepower output, see page 55.

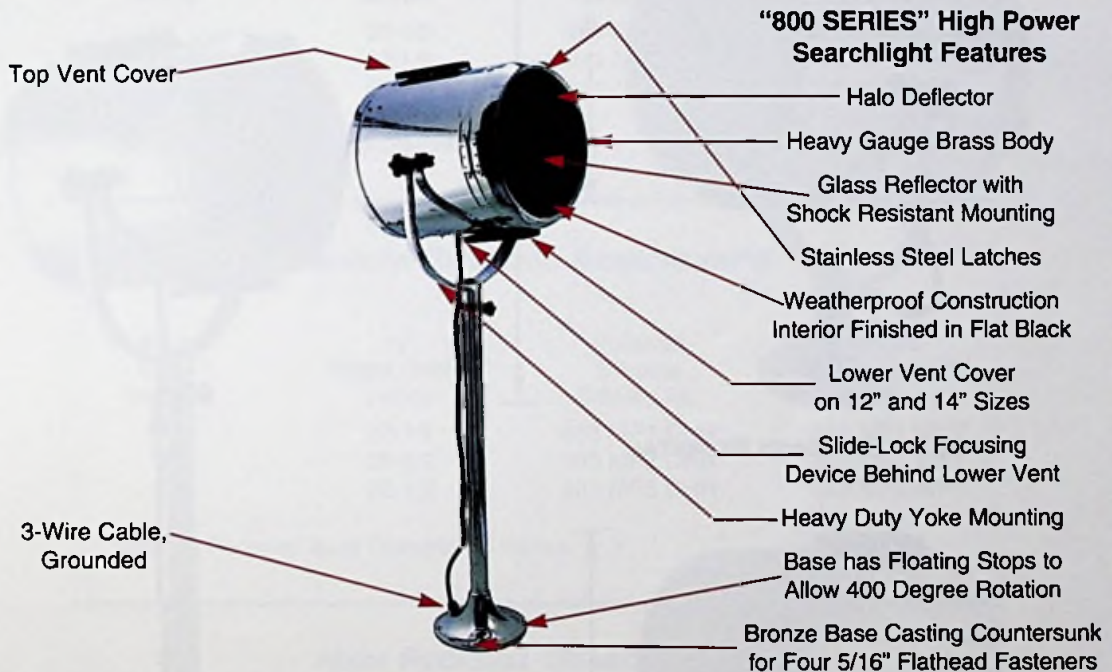

### CONTROL TYPES



#### DECK CONTROL

Equipped with handles on the rear cover for positioning.

#### LEVER CONTROL

Aim handle for horizontal position. Move handle up and down for vertical position.

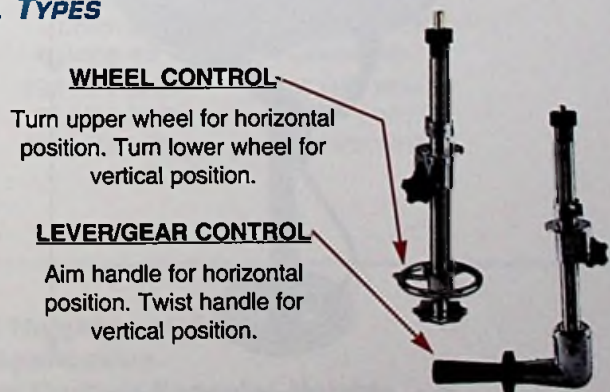

#### WHEEL CONTROL

Turn upper wheel for horizontal position. Turn lower wheel for vertical position.

#### LEVER/GEAR CONTROL

Aim handle for horizontal position. Twist handle for vertical position.



## DECK CONTROL SOLAR-RAY® SEARCHLIGHTS

### 883 SERIES

10", 12" OR 14"

#### SEARCHLIGHT DIMENSIONS

"A" Nominal Drum Diameter Inches	"C" Length Drum Inches	Nominal Weight Pounds
10	13	28
12	15	38
14	17	45

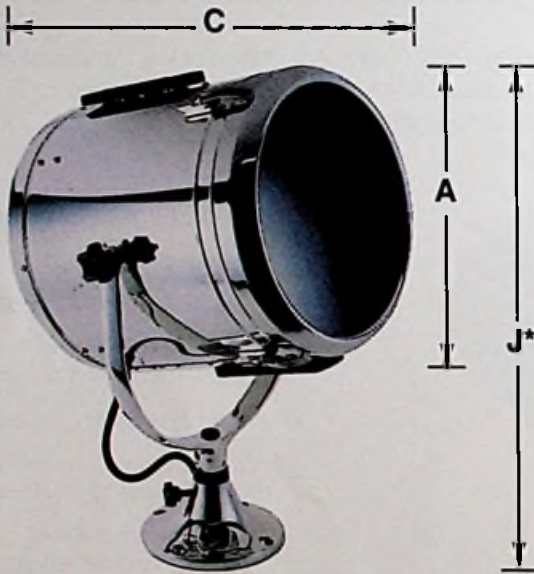

FIG. 883 - STANDARD PEDESTAL



FIG. 883 - HIGH PEDESTAL



FIG. 883 - MEDIUM PEDESTAL

\* Note: The "J" Dimension is Height Overall.



**DECK CONTROL SOLAR RAY® SEARCHLIGHTS****883 SERIES****10", 12" OR 14"****ORDERING INFORMATION**

- NOTES: 1) These Searchlights Can Not Be Fitted With Controls.  
 2) Bulbs Must be Ordered Separately, Refer to Pages 54 and 55 for Ordering Information.  
 3) Refer to Worksheet on Page 56 For Help in Ordering.

**STANDARD PEDESTAL SEARCHLIGHTS**

Reflector Size Inches	"J" Height Overall Inches	Polished Chrome Catalog No.	White PERKO•KOTE Catalog No.
10	20-1/8	883 0P1 CHR	883 0P1 WHT
12	22-1/8	883 0P2 CHR	883 0P1 WHT
14	25-1/8	883 0P3 CHR	883 0P3 WHT

Standard Pedestal Base Diameter, 7 Inches.

**MEDIUM PEDESTAL SEARCHLIGHTS**

Reflector Size Inches	"J" Height Overall Inches	Polished Chrome Catalog No.	White PERKO•KOTE Catalog No.
10	27-1/2	883 MP1 CHR	883 MP1 WHT
12	29-1/2	883 MP2 CHR	883 MP1 WHT
14	32-1/2	883 MP3 CHR	883 MP3 WHT

Medium Pedestal Base Diameter, 8 Inches.

**HIGH PEDESTAL SEARCHLIGHTS**

Reflector Size Inches	"J" Height Overall Inches	Polished Chrome Catalog No.	White PERKO•KOTE Catalog No.
10	44	883 HP1 CHR	883 HP1 WHT
12	46	883 HP2 CHR	883 HP1 WHT
14	49	883 HP3 CHR	883 HP3 WHT

High Pedestal Base Diameter, 8 Inches.

**NOTE: Custom Pedestal Heights are Available.  
 Price Upon Application.  
 Specify the "J" Dimension for Custom Pedestal Height.**



## LEVER CONTROL SOLAR-RAY® SEARCHLIGHTS

### 884 SERIES

10", 12" AND 14"

#### SEARCHLIGHT DIMENSIONS

"A" Nominal Drum Diameter Inches	"C" Length Drum Inches	Nominal Weight Pounds
10	13	28
12	15	38
14	17	45

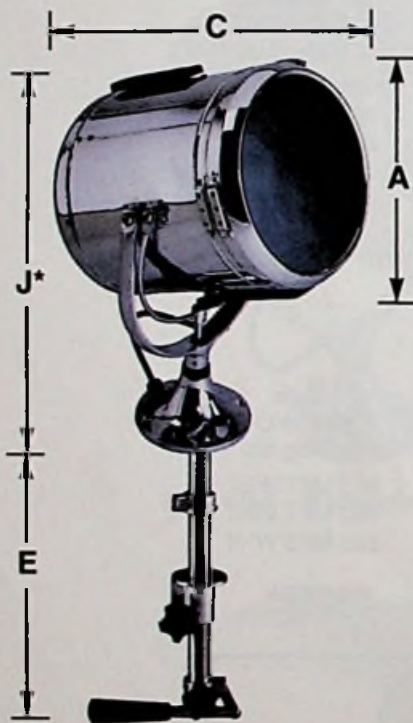

**FIG. 884**  
**STANDARD PEDESTAL**

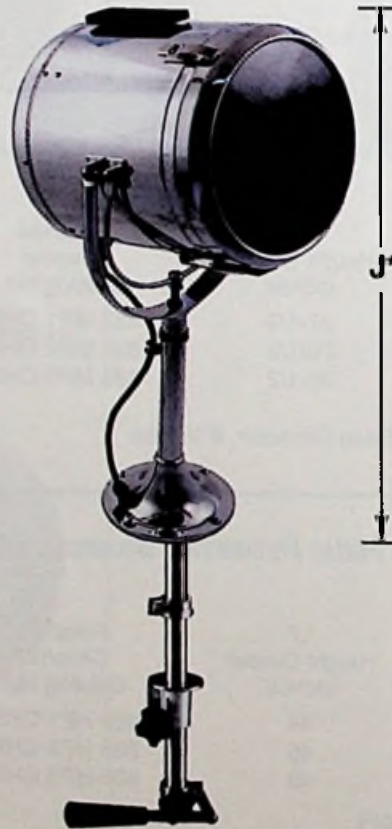

**FIG. 884**  
**MEDIUM PEDESTAL**

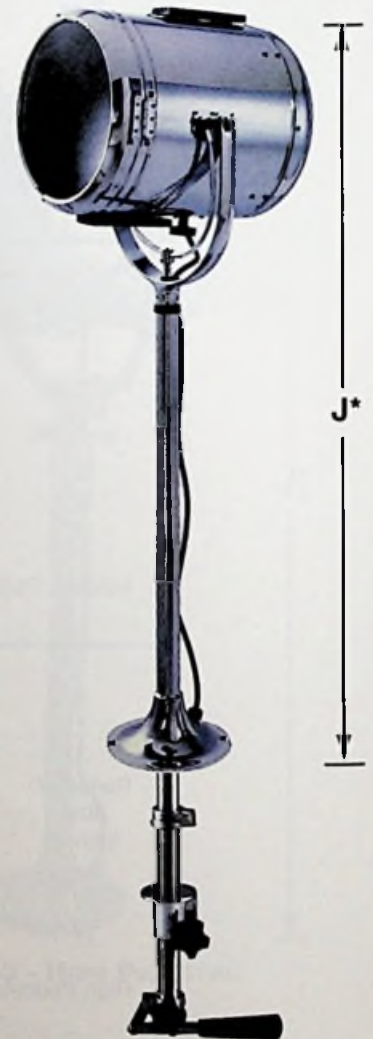

**FIG. 884**  
**HIGH PEDESTAL**

\* Note: The "J" Dimension is Height Overall.



**LEVER CONTROL SOLAR-RAY® SEARCHLIGHT HEAD ASSEMBLIES**

**884 SERIES  
10", 12" AND 14"**

**ORDERING INFORMATION**

- NOTES: 1) Bulbs Must be Ordered Separately, Refer to Pages 54 and 55 for Ordering Information.  
2) Refer to Worksheet on Page 56 For Help in Ordering.

**STANDARD PEDESTAL SEARCHLIGHT HEAD ASSEMBLIES**

Reflector Size Inches	"J" Height Inches	Polished Chrome Catalog No.	White PERKO•KOTE Catalog No.
10	20-1/8	884 0P1 CHR	884 0P1 WHT
12	22-1/8	884 0P2 CHR	884 0P2 WHT
14	25-1/8	884 0P3 CHR	884 0P3 WHT

Standard Pedestal Base Diameter, 7 Inches.

**MEDIUM PEDESTAL SEARCHLIGHT HEAD ASSEMBLIES**

Reflector Size Inches	"J" Height Inches	Polished Chrome Catalog No.	White PERKO•KOTE Catalog No.
10	28-1/4	884 MP1 CHR	884 MP1 WHT
12	30-1/4	884 MP2 CHR	884 MP2 WHT
14	33-1/4	884 MP3 CHR	884 MP3 WHT

Medium Pedestal Base Diameter, 8 Inches.

**HIGH PEDESTAL SEARCHLIGHT HEAD ASSEMBLIES**

Reflector Size Inches	"J" Height Inches	Polished Chrome Catalog No.	White PERKO•KOTE Catalog No.
10	44-3/4	884 HP1 CHR	884 HP1 WHT
12	46-3/4	884 HP2 CHR	884 HP2 WHT
14	49-3/4	884 HP3 CHR	884 HP3 WHT

High Pedestal Base Diameter, 8 Inches.

**NOTE: Custom Pedestal Heights are Available. Price Upon Application. Specify the "J" Dimension for Custom Pedestal Height.**

**FIG. 851 - LEVER CONTROL ASSEMBLIES**

Control assemblies of different lengths may be interchanged on Solar-Ray® searchlights (Fig. 884) of the same pedestal height. The following chart makes it possible to order and stock different styles of these assemblies separately to offer a large variety of Solar-Ray® searchlights with a minimum of inventory.

**ORDERING INFORMATION**

"E" Length Control Inches	For Standard Pedestal Cat. No.	For Medium Pedestal Cat. No.	For High Pedestal Cat. No.	Nominal Weight Pounds
8-1/2	851 000*	851 M00*	851 H00*	6
15-1/2	851 0A0	851 MA0	851 HA0	9
22-1/2	851 0B0	851 MB0	851 HB0	12
29-1/2	851 0C0	851 MC0	851 HC0	15

\* Maximum Ceiling Thickness, 4-1/2 Inches.

**NOTE: Custom Control Lengths are Available. Price Upon Application. Specify the "E" Dimension for Custom Control Lengths.**



## WHEEL OR LEVER/GEAR CONTROL SOLAR-RAY® SEARCHLIGHTS

### 885 SERIES

10", 12" AND 14"

#### SEARCHLIGHT DIMENSIONS

"A" Nominal Drum Diameter Inches	"C" Length Drum Inches	Nominal Weight Pounds
10	13	28
12	15	38
14	17	45

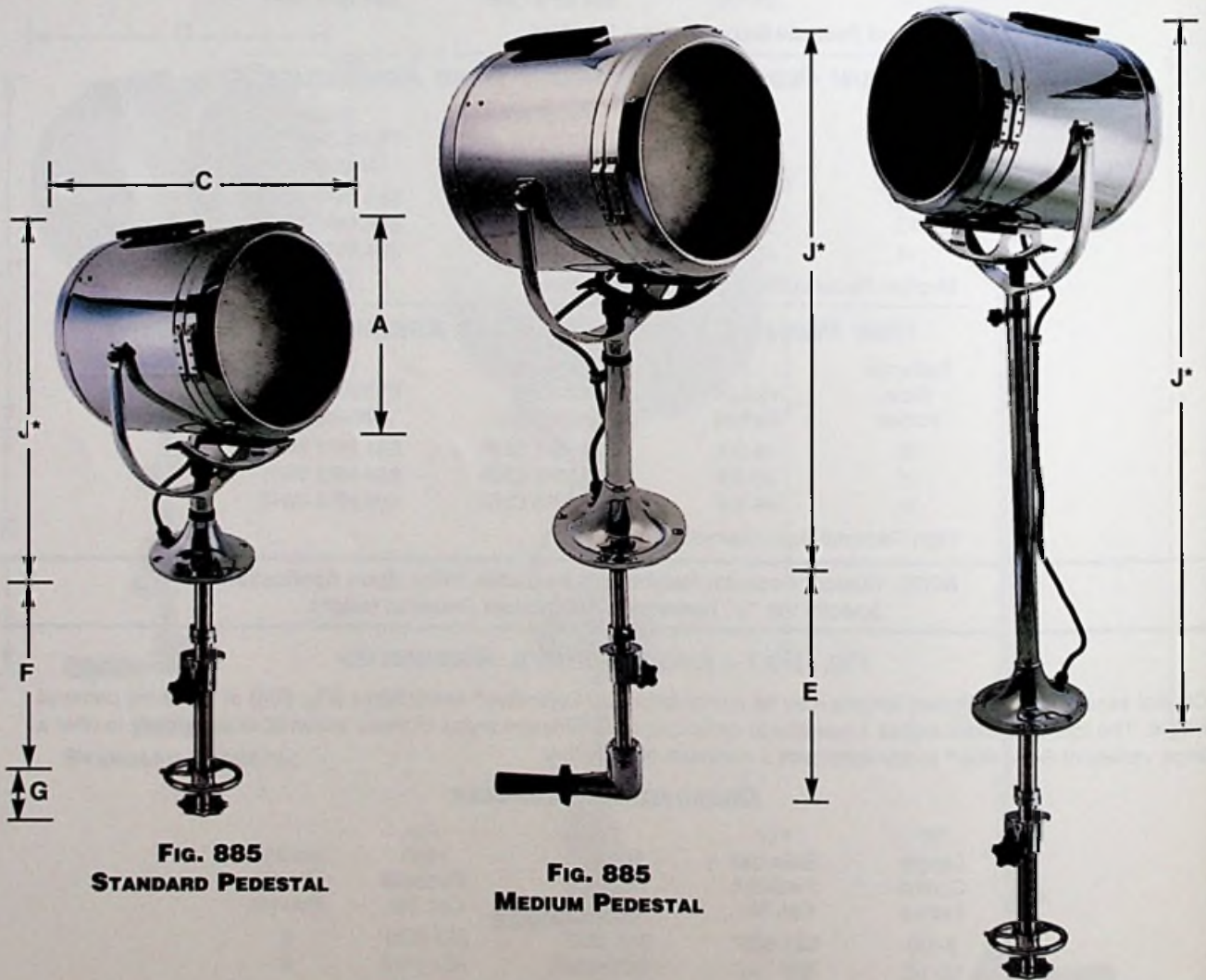

**FIG. 885  
STANDARD PEDESTAL**

**FIG. 885  
MEDIUM PEDESTAL**

**FIG. 885  
HIGH PEDESTAL**

\* Note: The "J" Dimension is Height Overall.



## WHEEL OR LEVER/GEAR CONTROL SOLAR-RAY® SEARCHLIGHTS HEAD ASSEMBLIES

### 885 SERIES

10", 12" AND 14"

#### ORDERING INFORMATION

- Notes: 1) Bulbs Must be Ordered Separately, Refer to Pages 54 and 55 for Ordering Information.  
2) Refer to Worksheet on Page 56 For Help in Ordering.

#### STANDARD PEDESTAL SEARCHLIGHT HEAD ASSEMBLIES

Reflector Size Inches	"J" Height Overall Inches	Polished Chrome Catalog No.	White PERKO•KOTE Catalog No.
10	20-1/8	885 0P1 CHR	885 0P1 WHT
12	22-1/8	885 0P2 CHR	885 0P2 WHT
14	25-1/8	885 0P3 CHR	885 0P3 WHT

Standard Pedestal Base Diameter, 7 Inches.

#### MEDIUM PEDESTAL SEARCHLIGHT HEAD ASSEMBLIES

Reflector Size Inches	"J" Height Overall Inches	Polished Chrome Catalog No.	White PERKO•KOTE Catalog No.
10	28-1/4	885 MP1 CHR	885 MP1 WHT
12	30-1/4	885 MP2 CHR	885 MP2 WHT
14	33-1/4	885 MP3 CHR	885 MP3 WHT

Medium Pedestal Base Diameter, 8 Inches.

#### HIGH PEDESTAL SEARCHLIGHT HEAD ASSEMBLIES

Reflector Size Inches	"J" Height Overall Inches	Polished Chrome Catalog No.	White PERKO•KOTE Catalog No.
10	44-3/4	885 HP1 CHR	885 HP1 WHT
12	46-3/4	885 HP2 CHR	885 HP2 WHT
14	49-3/4	885 HP3 CHR	885 HP3 WHT

High Pedestal Base Diameter, 8 Inches.

**NOTE: Custom Pedestal Heights are Available. Price Upon Application. Specify the "J" Dimension for Custom Pedestal Height.**

#### CONTROL ASSEMBLIES - FIGS. 852 & 969

Control Assemblies of different lengths may be interchanged on Solar-Ray® searchlights (Fig. 885) of the same pedestal height. The following chart makes it possible to order and stock different styles of these assemblies separately to offer a large variety of Solar-Ray® Searchlights with a minimum of inventory.

#### WHEEL CONTROL - FIG. 852

##### ORDERING INFORMATION

"F" Length Control Inches	For Standard Pedestal Cat. No.	For Medium Pedestal Cat. No.	For High Pedestal Cat. No.	Nominal Weight Pounds
7-1/2	852 000*	852 M00*	852 H00*	6
14-1/2	852 0A0	852 MA0	852 HA0	9
21-1/2	852 0B0	852 MB0	852 HB0	12
28-1/2	852 0C0	852 MC0	852 HC0	15

"G" Distance Between Wheels, 2 Inches.

\*Maximum Ceiling Thickness, 3 Inches.

#### LEVER/GEAR CONTROL - FIG. 969

##### ORDERING INFORMATION

"E" Length Control Inches	For Standard Pedestal Cat. No.	For Medium Pedestal Cat. No.	For High Pedestal Cat. No.	Nominal Weight Pounds
8-1/2	969 000*	969 M00*	969 H00*	6
15-1/2	969 0A0	969 MA0	969 HA0	9
22-1/2	969 0B0	969 MB0	969 HB0	12
29-1/2	969 0C0	969 MC0	969 HC0	15

\*Maximum Ceiling Thickness, 3-1/2 Inches.

**NOTE: Custom Control Lengths are Available. Price Upon Application. Specify the "E" or "F" Dimension for Custom Control Lengths.**



## BULB AND SOCKET ORDERING INFORMATION FOR SOLAR-RAY® SEARCHLIGHTS

### 800 SERIES - 10", 12" AND 14"

**BULBS ARE NOT INCLUDED IN LIGHTS**

To give good results, the bulb and reflector must be perfectly compatible; therefore be sure to specify the catalog number of the bulb desired. Peak candlepower is exceedingly sensitive to many factors, (i.e., a light source out of focus by 1/32 inch, under-voltage of only 4%, or differences between bulb manufacturers) which can cause a reduction of range of up to 20%.

#### INCANDESCENT BULB ORDERING INFORMATION

Bulb Catalog Number	Voltage	Wattage	Socket Type	Socket Code Letter	For Searchlight Sizes Inches	Rated* Life Hours	Mfg. Bulb Code
806	32	500	Medium Screw	B	10, 12, 14	50	DLT
807	120	500	Medium Prefocus	E	10, 12, 14	25	CZX
809	120	750	Medium Prefocus	E	12, 14	25	DPJ
837	120	750	Medium Prefocus	E	12, 14	200	DDY
810	120	1000	Medium Prefocus	E	12, 14	25	DRS
811	120	1000	Mogul Screw	D	12, 14	25	DRW
860	230	1000	Medium Prefocus	E	12, 14	50	DWK

For a More Concentrated Beam, Longer Range, Brighter Light and a Longer Life, We Recommend the Following Bulbs:

#### "QUARTZ" TUNGSTEN-HALOGEN BULB ORDERING INFORMATION

Bulb Catalog Number	Voltage	Wattage	Socket Type	Socket Code Letter	For Searchlight Sizes Inches	Rated* Life Hours	Mfg. Bulb Code
816	12	100	2-Pin Prefocus	F	10, 12, 14	50	FDT
836	24	150	2-Pin Prefocus	G	10, 12, 14	50	DZE-FDS
817	32	200	2-Pin Prefocus	H	10, 12, 14	200	G.E. 1945
844	120	500	Medium Prefocus	E	10, 12, 14	500	BTL
820	120	600	2-Pin Prefocus	I	10, 12, 14	75	DYS
845	120	750	Medium Prefocus	E	12, 14	200	BTP
839	120	900	2-Pin Prefocus	K	12, 14	75	BVA
846	120	1000	Medium Prefocus	E	12, 14	200	BTR

**PLEASE ORDER CAREFULLY, BULBS ARE NOT RETURNABLE.**

*\*NOTE: These are the "Rated Average Laboratory Life in Hours" of the Bulb Manufacturer obtained in closely controlled laboratory life testing groups of lamps at their design voltage. It is not necessarily the same as the service life where conditions such as shock, vibration, voltage fluctuation and environment may result in a shorter average attained life.*

#### ELECTRIC SOCKET AND SUPPORT STAND ASSEMBLIES

Solar-Ray® Searchlights include a socket and support stand assembly based on the bulb or socket information given when ordering. The following chart makes it possible to order and stock different socket and stand assemblies for field conversion to meet a large variety of voltage and candlepower requirements with a minimum of inventory.

#### ORDERING INFORMATION

Socket Type	Socket Code	For 10" Searchlights		For 12" Searchlights		For 14" Searchlights	
		Catalog Number	Height Stand Inches	Catalog Number	Height Stand Inches	Catalog Number	Height Stand Inches
Medium Screw	B	872 001	1-1/4	872 002	2-1/4	872 003	3-1/4
Medium Prefocus	E	873 001	1-5/16	873 002	1-15/16	873 003	2-15/16
Mogul Screw	D	-----	-----	874 002	7/16	874 003	1-1/4
2-Pin Prefocus (12 Volt)	F	875 001	3-1/2	875 002	4-1/2	875 003	5-1/2
2-Pin Prefocus (24 Volt)	G	876 001	3-1/4	876 002	4-1/4	876 003	5-1/4
2-Pin Prefocus (32 Volt)	H	878 001	3-1/4	878 002	4-1/4	878 003	5-1/4
2-Pin Prefocus (600 Watt)	I	879 001	3-1/8	879 002	4-1/8	879 003	5-1/8
2-Pin Prefocus (900 Watt)	K	-----	-----	880 002	3-13/16	880 003	4-13/16

**NOTE: Refer to Page 60 for Spare/Replacement Electric Socket Only Ordering Information.**



## BULB TECHNICAL DATA FOR SOLARFLAY® SEARCHLIGHTS

### 800 SERIES

THE FOLLOWING CHART IS PROVIDED TO AID IN PROPER BULB SELECTION:

Searchlight Size Inches	Voltage	Approximate Range Miles*	Bulb Catalog Number	Bulb Wattage	Rated Life Hours**	Maximum Candlepower Output	Horizontal Beam Spread Degrees	Vertical Beam Spread Degrees
10"	12	1	816	100	50	1,168,000	1.7	1.4
	24	1	836	150	50	891,000	2.6	1.5
	32	3/4	817	200	200	571,000	2.6	1.7
	32	1	806	500	50	943,000	3.4	3.9
	120	1	820	600	75	908,000	4.4	2.2
	120	1-1/8	807	500	25	1,332,000	3.5	2.8
	120	1-1/8	844	500	500	1,260,000	3.1	3.4
12"	12	1-1/4	816	100	50	1,617,000	1.5	1.2
	24	1-1/8	836	150	50	1,349,000	2.2	1.5
	32	7/8	817	200	200	865,000	2.4	1.6
	32	1-1/8	806	500	50	1,496,000	3.4	3.5
	120	1	837	750	200	977,000	4.1	3.7
	120	1	845	750	200	1,185,000	3.7	5.2
	120	1-1/8	820	600	75	1,410,000	4.3	1.9
	120	1-1/4	809	750	25	1,747,000	3.6	3.4
	120	1-1/4	844	500	500	1,641,000	3.2	3.4
	120	1-1/4	807	500	25	1,799,000	3.3	3.1
	120	1-1/4	811	1000	25	1,816,000	4.0	4.9
	120	1-3/8	810	1000	25	1,894,000	4.0	3.8
	120	1-3/8	846	1000	200	1,911,000	3.9	5.0
	120	1-1/2	839	900	75	2,482,000	4.5	5.5
230	7/8	860	1000	25	865,000	6.9	5.9	
14"	12	1-1/4	816	100	50	1,756,000	1.5	1.0
	24	1-1/8	836	150	50	1,367,000	2.3	1.2
	32	1	817	200	200	943,000	2.2	1.5
	32	1-1/8	806	500	50	1,591,000	4.0	3.7
	120	1-1/8	837	750	200	1,254,000	3.9	4.5
	120	1-1/8	845	750	200	1,531,000	3.6	5.1
	120	1-1/4	820	600	75	1,626,000	4.5	1.9
	120	1-3/8	844	500	500	1,840,000	2.9	3.2
	120	1-3/8	811	1000	25	2,249,000	4.0	5.1
	120	1-1/2	807	500	25	2,353,000	3.2	3.2
	120	1-1/2	809	750	25	2,361,000	3.7	4.0
	120	1-1/2	846	1000	200	2,586,000	3.8	5.0
	120	1-1/2	810	1000	25	2,621,000	4.0	4.5
	120	1-5/8	839	900	75	2,889,000	4.5	5.2
	230	1	860	1000	50	1,021,000	7.7	6.2

\*The approximate ranges listed above are based on photometric measurements of beam candlepower output under ideal conditions. Many factors such as atmospheric conditions, size and color of target, background, etc., may reduce effective range considerably; therefore, these figures are offered only as a guide to compare different bulb and voltage options.

\*\*NOTE: These are the "Rated Average Laboratory Life in Hours" of the Bulb Manufacturer obtained in closely controlled laboratory life testing of groups of lamps at their design voltage. It is not necessarily the same as the service life where conditions such as shock, vibration, voltage fluctuation and environment may result in a shorter average attained life.



2-PIN PREFOCUS



MOGUL SCREW



MEDIUM PREFOCUS



MEDIUM SCREW



## SOLAR-RAY® SEARCHLIGHT ORDERING WORKSHEET

### 800 SERIES

- 1) **Head Assembly Type:** \_\_\_\_\_
  - a) For deck control - 883
  - b) For lever control - 884
  - c) For wheel and lever/gear control - 885
- 2) **Pedestal (overall) Height (see catalog page for details):** \_\_\_\_\_
  - a) Standard - O
  - b) Medium - M
  - c) High - H

*For custom pedestal height see no. 10 below.*
- 3) **Reflector Size:** \_\_\_\_\_
  - a) 10 inch - 1
  - b) 12 inch - 2
  - c) 14 inch - 3
- 4) **Finish:** \_\_\_\_\_
  - a) PERKOPLATE (polished chrome) - CHR
  - b) PERKO•KOTE (white) - WHT
- 5) **Control Type:** \_\_\_\_\_
  - a) Lever control (For 884 Head Assembly) - 851
  - b) Wheel control (For 885 Head Assembly) - 852
  - c) Lever/Gear control (For 885 Head Assembly) - 969
- 6) **Control Length (when necessary):** \_\_\_\_\_
  - a) (8-1/2" for 851 & 969) or (7-1/2" for 852) - 0
  - b) (15-1/2" for 851 & 969) or (14-1/2" for 852) - A
  - c) (22-1/2" for 851 & 969) or (21-1/2" for 852) - B
  - d) (29-1/2" for 851 & 969) or (28-1/2" for 852) - C
- 7) **Bulb Number (see pages 54 & 55 for details):** \_\_\_\_\_
- 8) **Socket Type:** .....Code: \_\_\_\_\_
  - a) Medium Screw ..... "B"
  - b) Medium Prefocus ..... "E"
  - c) Mogul Screw ..... "D" (Not for use with 10 inch reflector.)
  - d) 2-Pin Prefocus (12 volt) ..... "F"
  - e) 2-Pin Prefocus (24 volt) ..... "G"
  - f) 2-Pin Prefocus (32 volt) ..... "H"
  - g) 2-Pin Prefocus (600 Watt) ..... "I"
  - h) 2-Pin Prefocus (900 watt) ..... "K" (Not for use with 10 inch reflector.)
- 9) **Custom control length:** \_\_\_\_\_  
Specify control length desired as measured from pedestal base to lower end of control assembly ("E" or "F" dimension).
- 10) **Custom pedestal height:** \_\_\_\_\_  
Specify overall height of searchlight desired as measured from the top of the searchlight head to the bottom of the pedestal base ("J" dimension).

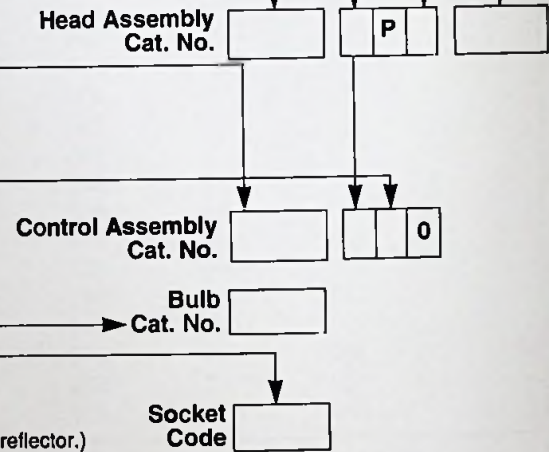

### SPARE PARTS FOR 800 SERIES SOLAR-RAY® SEARCHLIGHTS

Fig.	Size	Front Glass Cat. No.	Front Door with Glass Cat. No.	Rear Cover Cat. No.	Reflector* Cat. No.	Pinion Gear Cat. No.
883	10"	889 001 CLR	891 001 CHR	908 001 CHR	890 001	----
	12"	889 002 CLR	891 002 CHR	908 002 CHR	890 002	----
	14"	889 003 CLR	891 003 CHR	908 003 CHR	890 003	----
884	10"	889 001 CLR	891 001 CHR	902 001 CHR	890 001	----
	12"	889 002 CLR	891 002 CHR	902 002 CHR	890 002	----
	14"	889 003 CLR	891 003 CHR	902 003 CHR	890 003	----
885 and 886	10"	889 001 CLR	891 001 CHR	902 001 CHR	890 001	905
	12"	889 002 CLR	891 002 CHR	902 002 CHR	890 002	905
	14"	889 003 CLR	891 003 CHR	902 003 CHR	890 003	905

**NOTE:** The Spare Part catalog numbers listed above are for the polished chrome (CHR) finish. To order white finish, replace the "CHR" in the catalog number with the "WHT" finish code.

\*Replacement Retaining Clips (Cat. No. 910) For The Reflector Should Also Be Ordered When Ordering a Replacement Reflector To Assure a Proper Fit.



## 19 INCH SOLAR-RAY® SEARCHLIGHT

### 1900 SERIES

**ALL ALUMINUM - WHITE PERKO•KOTE FINISH**

**32, 120 OR 230 VOLTS**

The 1900 Series - Solar-Ray® Searchlights are designed and built with the commercial user in mind where maximum size and brilliance counts. These units are constructed of marine aluminum with heavy duty castings and heavy gauge reinforced bodies for extra durability. They are finished in our white PERKO•KOTE finish; an advanced process that eliminates the need for painting while providing a scratch resistant and chip-proof surface for painting when necessary to match the color of the vessel.

The 1900 Series is available with Deck, Wheel or Lever/Gear Controls. All models feature halo deflectors, parabolic glass mirror reflectors for maximum light output and ventilation covers for quick dissipation of heat to help prolong bulb life. Hinged front doors have quick release stainless steel latches to provide easy access for bulb replacement.

Bulbs are not included and must be ordered separately. PERKO offers a choice of the traditional incandescent or the brighter, more piercing quartz-halogen bulbs in a variety of voltages and wattages. For complete information on bulbs and candlepower output, see page 59.

### "1900 Series" High Power Searchlights Features



**Figs. 1901 & 1902**

### CONTROL TYPES



**FIG. 1922**

**WHEEL CONTROL**  
Turn upper wheel for horizontal position. Turn Lower Wheel for vertical position.

**DECK CONTROL**  
Equipped with handles on the rear cover for positioning.

**LEVER/GEAR CONTROL**  
Aim handle for horizontal position. Twist handle for vertical position.



**FIG. 1921**



## 19 INCH SOLAR-RAY® SEARCHLIGHTS

### SEARCHLIGHT DIMENSIONS

Nominal Drum Diameter Inches	Nominal Drum Weight Pounds	Nominal Control Weight Pounds
19	72	22

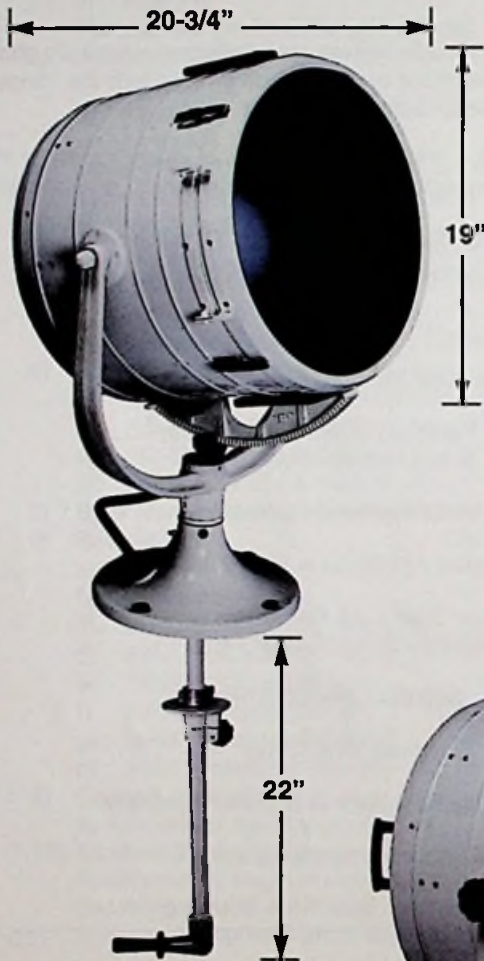

**FIG. 1902  
LEVER/GEAR CONTROL**



**FIG. 1901  
DECK CONTROL**

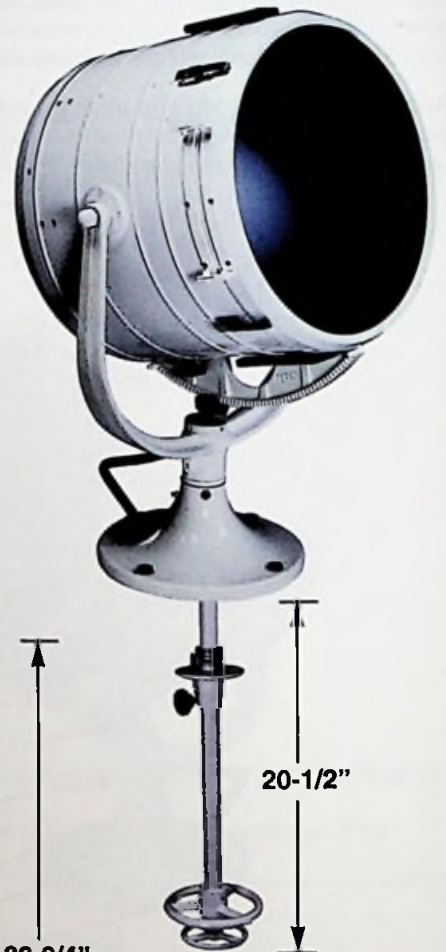

**FIG. 1902  
WHEEL CONTROL**

Base Diameter, 13 Inches.  
Distance Between Wheels, 2-1/2 Inches.



## 19 INCH SOLAR-RAY® SEARCHLIGHT HEAD AND CONTROL ASSEMBLIES

### ALL ALUMINUM - WHITE PERKO•KOTE FINISH ORDERING INFORMATION

Description	Catalog No.
Deck Control Searchlight Head Assembly*	1901 004 WHT
Wheel or Lever/Gear Control Searchlight Head Assembly (Requires Control Assembly Below)	1902 004 WHT
Wheel Control Assembly (For Above)	1922 000 WHT
Lever/Gear Control Assembly (For Above)	1921 000 WHT

\*Can Not Be Fitted With Controls.

Custom Control Lengths and Pedestal Heights Are Available. Price Upon Application. Specify Measurements.

**BULBS ARE NOT INCLUDED IN LIGHTS**

### BULB ORDERING INFORMATION FOR 19 INCH SEARCHLIGHTS

To give good results, the bulb and reflector must be perfectly compatible; therefore be sure to specify the catalog number of the bulb desired. Peak candlepower is exceedingly sensitive to many factors, (i.e., a light source out of focus by 1/32 inch, under-voltage of only 4%, or differences between bulb manufacturers can cause a reduction of range of up to 20%).

For a More Concentrated Beam, Longer Range, Brighter Light and a Longer Life, We Recommend the Quartz/Halogen Bulbs.

Voltage	Approx. Range Miles*	Bulb Catalog Number	Bulb Type	Socket Type	Socket Code Letter	Wattage	Rated Life Hours**	Maximum Candlepower Output	Horizontal Beam Spread Degrees	Vertical Beam Spread Degrees	Mfg. Bulb Code
32	1-2/3	806	Incandescent	Medium Screw	B	500	50	3,520,000	3.5	3.7	DLT
120	1-3/8	837	Incandescent	Medium Prefocus	E	750	200	2,076,000	3.6	4.2	DDY
120	1-5/8	845	Quartz/Halogen	Medium Prefocus	E	750	200	2,871,000	3.6	5.4	BTP
120	1-5/8	807	Incandescent	Medium Prefocus	E	500	25	3,191,000	3.5	4.0	CZX
120	1-2/3	859	Quartz/Halogen	Mogul Prefocus	M	2000	250	3,633,000	9.4	5.9	BVW
120	1-2/3	847	Quartz/Halogen	Mogul Prefocus	M	1000	200	3,659,000	4.5	5.4	BVV
120	1-3/4	844	Quartz/Halogen	Medium Prefocus	E	500	500	3,861,000	3.0	5.4	BTL
120	1-3/4	809	Incandescent	Medium Prefocus	E	750	25	4,454,000	3.6	4.5	DPJ
120	1-7/8	846	Quartz/Halogen	Medium Prefocus	E	1000	200	4,601,000	4.5	5.4	BTR
120	2	848	Quartz/Halogen	Mogul Prefocus	L	1500	100	5,596,000	5.9	5.7	DTA
120	2	810	Incandescent	Medium Prefocus	E	1000	25	5,622,000	3.6	4.2	DRS
120	2	839	Quartz/Halogen	2-Pin Prefocus	K	900	75	5,769,000	5.9	5.4	BVA
120	2-1/8	840	Incandescent	Mogul Prefocus	L	1500	25	5,968,000	5.6	5.4	DTJ
230	1-3/8	860	Incandescent	Medium Prefocus	E	1000	50	2,162,000	7.9	6.5	DWK

\*The approximate ranges listed above are based on photometric measurements of beam candlepower output under ideal conditions. Many factors such as atmospheric conditions, size and color of target, background, etc., may reduce effective range considerably; therefore, these figures are offered only as a guide to compare different bulb and voltage options.

**PLEASE ORDER CAREFULLY, BULBS ARE NOT RETURNABLE.**

\*\*NOTE: These are the "Rated Average Laboratory Life in Hours" of the Bulb Manufacturer obtained in closely controlled laboratory life testing of groups of lamps at their design voltage. It is not necessarily the same as the service life where conditions such as shock, vibration, voltage fluctuation and environment may result in a shorter average attained life.

### Electric Socket and Support Stand Assemblies for 19 Inch Searchlights

Solar-Ray® Searchlights include a socket and support stand based on the bulb or socket information given when ordering. The following chart makes it possible to order and stock different assemblies for field conversion, to meet a large variety of voltage and candlepower requirements with a minimum of inventory.

#### ORDERING INFORMATION

Socket Type	Socket Code	Socket & Stand Catalog Number	Height Stand Inches
Medium Screw	B	872 004	5-3/4
Medium Prefocus	E	873 004	5-7/16
Mogul Prefocus (1500 Watt)	L	1930 004	3-5/8
Mogul Prefocus (1000 & 2000 Watt)	M	1931 004	3-1/8
2-Pin Prefocus (900 Watt)	K	880 004	7-5/16



## SPARE PARTS FOR 1900 SERIES SOLAR-RAY® SEARCHLIGHTS

### ORDERING INFORMATION

Fig. No.	Front Glass Cat. No.	Front Door with Glass Cat. No.	Rear Cover Cat. No.	Reflector* Cat. No.	Pinion Gear Cat. No.
1901	889 004 CLR	1936 000 WHT	1932 000 WHT	890 004	----
1902	889 004 CLR	1936 000 WHT	1933 000 WHT	890 004	905
1903	889 004 CLR	1936 000 WHT	1933 000 WHT	890 004	905

\*Replacement Retaining Clips (Cat. No. 911) for the Reflector Should Also Be Ordered When Ordering a Replacement Reflector to Assure a Proper Fit.

## SPARE SOCKETS FOR 800 SERIES AND 1900 SERIES SOLAR-RAY® SEARCHLIGHTS

### ORDERING INFORMATION



Medium Screw Socket  
(Code "B")  
Catalog No. 894.



Medium Prefocus Socket  
(Code "E")  
Catalog No. 895.

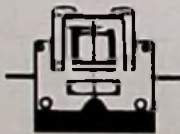

2-Pin Prefocus Socket  
(Codes "F, G, H & I\*\*")  
Catalog No. 899.

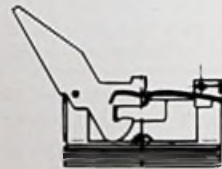

2-Pin Prefocus Socket  
(Code "K\*\*")  
Catalog No. 866.



Mogul Screw Socket  
(Codes "D")  
Catalog No. 897.

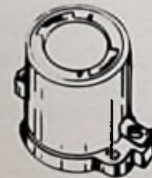

Mogul Prefocus Socket  
(Codes "L & M")  
Catalog No. 893.

\*For Use In 10", 12" and 14" Searchlights Except When Catalog No. 839, 900 Watt Bulb is Used.

\*\*For Use In 12", 14" and 19" Searchlights Only When the Catalog No. 839, 900 Watt Bulb is Used.



## DOVE LIGHTS

**FIG. 308 - FLUSH MOUNT DOME LIGHT**

**DOUBLE CONTACT BAYONET SOCKET  
PUSH SWITCH WITH WATER RESISTANT BOOT  
COMPLETE WITH 12 VOLT BULB.**

**CHROME PLATED ZINC**

**ORDERING INFORMATION**

O.D. Globe Inches	O.D. Flange Inches	Depth Above Flange Inches	Depth Below Flange Inches	Maximum Wattage	Display Pkg. - 5 Cards 1 Pc. per Card	OEM Bulk Pkg. 10 Pcs.	Screw Size	Weight Ounces
3	3-3/4	5/8	3/4	11	308 DP0 CHR	308 000 CHR	10 R.H.	5
4	4-1/2	3/4	1-1/4	17	308 DP1 CHR	308 001 CHR	10 R.H.	7
5	5-1/2	3/4	1-1/2	17	308 DP2 CHR	-----	12 R.H.	9

Spare Bulbs (2 per card) for 3 Inch Light, Cat. No. 337 011 DP.  
Spare Bulbs (2 per card) for 4 Inch Light, Cat. No. 337 012 DP.  
Spare Bulbs (2 per card) for 5 Inch Light, Cat. No. 337 013 DP.

Spare Switch, Cat. No. 701 DP.  
Spare Socket, Cat. No. 24 DP1.  
Spare Globe, Cat. No. 308 99A, Specify Size.



**Fig. 308**

**FIG. 300 - SURFACE MOUNT DOME LIGHT**

**DOUBLE CONTACT BAYONET SOCKET  
PUSH SWITCH WITH WATER RESISTANT BOOT  
COMPLETE WITH 12 VOLT BULB.**

**CHROME PLATED ZINC  
BLACK VINYL MOUNTING GASKET**

**ORDERING INFORMATION**

O.D. Globe Inches	O.D. Base Inches	Depth Overall Inches	Maximum Wattage	Display Pkg. - 5 Cards 1 Pc. per Card	OEM Bulk Pkg. 10 Pcs.	Screw Size	Weight Ounces
3	3-3/4	1-1/2	11	300 DP0 CHR	300 000 CHR*	10 R.H.	7
4	5	1-7/8	17	300 DP1 CHR	300 001 CHR	10 R.H.	9
5	6	2	17	300 DP2 CHR	300 002 CHR	12 R.H.	11

\*OEM Bulk Pkg., 20 Pcs.

Spare Bulbs (2 per card) for 3 Inch Light, Cat. No. 337 011 DP.  
Spare Bulbs (2 per card) for 4 Inch Light, Cat. No. 337 012 DP  
Spare Bulbs (2 per card) for 5 Inch Light, Cat. No. 337 013 DP.

Spare Switch, Cat. No. 701 DP.  
Spare Socket, Cat. No. 24 DP1.  
Spare Globe, Cat. No. 257 DP, Specify Size.



**Fig. 300**

**FIG. 1253 - EXTERIOR DOME LIGHT**

**DOUBLE CONTACT BAYONET SOCKET  
PUSH SWITCH WITH WATER RESISTANT BOOT  
COMPLETE WITH 12 VOLT BULB.**

**IVORY PERKO•KOTE POWDER COATING  
BLACK VINYL MOUNTING GASKET**

**ORDERING INFORMATION**

O.D. Globe Inches	O.D. Base Inches	Depth Overall Inches	Maximum Wattage	Display Pkg. - 5 Cards 1 Pc. per Card	OEM Bulk Pkg. 10 Pcs.	Screw Size	Weight Ounces
4	5	1-7/8	17	1253 DP1 WHT	1253 001 WHT	10 R.H.	9
5	6	2	17	1253 DP2 WHT	1253 002 WHT	12 R.H.	11

Spare Bulbs (2 per card) for 4 Inch Light, Cat. No. 337 012 DP  
Spare Bulbs (2 per card) for 5 Inch Light, Cat. No. 337 013 DP.  
Spare Switch, Cat. No. 701 DP.

Spare Socket, Cat. No. 24 DP1.  
Spare Globe, Cat. No. 257 DP, Specify Size.



**Fig. 1253**



## DOME LIGHTS



**Fig. 1257**

**FIG. 1257 - SURFACE MOUNT DOME LIGHT**

**UNSWITCHED**

**FOR APPLICATIONS UTILIZING REMOTE SWITCHING.**

**COMPLETE WITH 12 VOLT, 10 WATT BULB.**

**WHITE TRANSLUCENT PLASTIC GLOBE**

**CHROME PLATED ZINC**

**ORDERING INFORMATION**

O.D. Base Inches	Depth Overall Inches	Maximum Wattage	Display Pkg. - 5 Cards 1 Pc. per Card	OEM Bulk Pkg. 10 Pcs.	Screw Size	Weight Ounces
3-3/4	1-1/4	10	1257 DP2 CHR	1257 002 CHR	8 R.H.	7

Spare Bulbs (2 per card), Cat. No. 70 DP0 CLR. Spare Globe, Cat. No. 244 002 WHT.



**Fig. 1258**

**FIG. 1258 - SURFACE MOUNT DOME LIGHT**

**PUSH SWITCH WITH WATER RESISTANT BOOT**

**COMPLETE WITH 12 VOLT, 10 WATT BULB.**

**WHITE TRANSLUCENT PLASTIC GLOBE**

**CHROME PLATED ZINC**

**ORDERING INFORMATION**

O.D. Base Inches	Depth Overall Inches	Maximum Wattage	Display Pkg. - 5 Cards 1 Pc. per Card	OEM Bulk Pkg. 10 Pcs.	Screw Size	Weight Ounces
3-3/4	1-1/4	10	1258 DP2 CHR	1258 002 CHR	8 R.H.	7

Spare Bulbs (2 per card), Cat. No. 70 DP0 CLR. Spare Switch, Cat. No. 701 DP. Spare Globe, Cat. No. 244 002 WHT.



**Fig. 1259**

**FIG. 1259 - SURFACE MOUNT DOME LIGHT**

**UNSWITCHED**

**FOR APPLICATIONS UTILIZING REMOTE SWITCHING.**

**COMPLETE WITH 12 VOLT, 10 WATT BULB.**

**WHITE TRANSLUCENT PLASTIC GLOBE**

**CHROME PLATED ZINC**

**ORDERING INFORMATION**

Dimensions Base Inches	Depth Overall Inches	Maximum Wattage	Display Pkg. - 5 Cards 1 Pc. per Card	OEM Bulk Pkg. 10 Pcs.	Screw Size	Weight Ounces
3-5/8 x 4-1/4	1-1/4	10	1259 DP2 CHR	1259 002 CHR	8 R.H.	10

Spare Bulbs (2 per card), Cat. No. 70 DP0 CLR. Spare Globe, Cat. No. 245 002 WHT.



**Fig. 1260**

**FIG. 1260 - SURFACE MOUNT DOME LIGHT**

**PUSH SWITCH WITH WATER RESISTANT BOOT**

**COMPLETE WITH 12 VOLT, 10 WATT BULB.**

**WHITE TRANSLUCENT PLASTIC GLOBE**

**CHROME PLATED ZINC**

**ORDERING INFORMATION**

Dimensions Base Inches	Depth Overall Inches	Maximum Wattage	Display Pkg. - 5 Cards 1 Pc. per Card	OEM Bulk Pkg. 10 Pcs.	Screw Size	Weight Ounces
3-5/8 x 4-1/4	1-1/4	10	1260 DP2 CHR	1260 002 CHR	8 R.H.	10

Spare Bulbs (2 per card), Cat. No. 70 DP0 CLR. Spare Switch, Cat. No. 701 DP. Spare Globe, Cat. No. 245 002 WHT.

**NOTE: TO USE THE LIGHTS ON THIS PAGE IN A 24 VOLT SYSTEM, ORDER REPLACEMENT BULBS (2 PER CARD) CAT. NO. 67 DP1 CLR.**



## DOME LIGHTS

### FIG. 555 - SURFACE MOUNT DOME LIGHT

**FOR SYSTEMS UP TO 50 VOLTS.  
MEDIUM SCREW SOCKET, TOGGLE SWITCH  
USES 15 WATT, A-17 BULB, NOT INCLUDED**

**CHROME PLATED BRONZE**

#### ORDERING INFORMATION

O.D. Globe Inches	O.D. Base Inches	Depth Inches	Standard Pkg. - 1 Pc.	Screw Size	Weight Pounds
6	7-7/8	3-1/8	555 000 CHR	8	4-1/2

Spare Switch, Cat. No. 514 DP.  
Spare Socket, Cat. No. 1323.  
Spare Globe, Cat. No. 257 DP6.



FIG. 555

### FIG. 753 - SURFACE MOUNT DOME LIGHT

**FOR SYSTEMS UP TO 50 VOLTS.  
MEDIUM SCREW SOCKET, TOGGLE SWITCHES  
BULBS NOT INCLUDED**

**SIZE NO. 1 HAS ONE SOCKET AND SWITCH.  
WILL ACCOMMODATE A BULB UP TO 50 WATTS.**

**SIZE NO. 2 HAS TWO SOCKETS AND SWITCHES.  
WILL ACCOMMODATE BULBS UP TO 25 WATTS.**

**CHROME PLATED WROUGHT BRASS**

#### ORDERING INFORMATION

O.D. Glass Inches	O.D. Base Inches	Depth Inches	Standard Pkg. - 1 Pc.	Screw Size	Weight Pounds
8	9-1/2	3	753 001 CHR	10 R.H.	2-1/2
8	9-1/2	3	753 002 CHR	10 R.H.	2-3/4

Spare Switch, Cat. No. 514 DP.  
Spare Socket, Cat. No. 1323.  
Spare Globe, Cat. No. 132 000 FRD.



FIG. 753

### FIG. 318 - SURFACE MOUNT LIGHT

**DUAL VOLTAGE, FOR 12 AND 120 VOLTS  
DOUBLE CONTACT BAYONET SOCKETS,  
COMPLETE WITH TWO 12 VOLT AND TWO 120 VOLTS BULBS.**

**WHITE TRANSLUCENT PLASTIC GLOBE  
WHITE PERKO-KOTE CAST ZINC BASE  
WITH INTEGRAL JUNCTION BOX**

#### ORDERING INFORMATION

Length Inches	Width Inches	Depth Inches	Display Pkg. - 5 Cards 1 Pc. per Card	OEM Bulk Pkg. 10 Pcs.	Screw Size	Weight Pounds
9-3/4	3-1/2	1-7/8	318 DP	318 A00	10	1-5/8

Spare 12 Volt Bulbs (2 per card), Cat. No. 337 012 DP. Spare Socket, Cat. No. 24 DP1.  
Spare 120 Volt Bulbs (2 per card), Cat. No. 337 023 DP. Spare Globe, Cat. No. 318 A00 99D.  
Spare Switches with Square Buttons (1 Each High and Low), Cat. No. 318 A00 99E.



FIG. 318



## UTILITY LIGHTS



**Fig. 1254**

### FIG. 1254 - ADJUSTABLE UTILITY LIGHT

**SHIELD SWIVELS TO CHANGE POSITION**

**COMPLETE WITH 12 VOLT, 7 WATT BULB.**

**CHROME PLATED ZINC**

#### ORDERING INFORMATION

O.D. Overall Inches	Length Neck Inches	O.D. Neck Inches	Display Pkg. - 5 Cards 1 Pc. per Card	OEM Bulk Pkg. 10 Pcs.	Screw Size	Weight Ounces
2-5/8	3/4	7/8	1254 DP CHR	1254 000 CHR	6	6

Spare Bulbs (2 per card), Cat. No. 337 011 DP.  
Spare Socket, Cat. No. 24 DP1.



### FIG. 137 - FIXED UTILITY LIGHT, COMPLETE WITH 12 VOLT, 1 WATT BULB, SHIELDED LIGHT COVER, MOLDED BLACK PLASTIC

### FIG. 140 - FIXED UTILITY LIGHT, COMPLETE WITH 12 VOLT, 1 WATT BULB, DIFFUSED LIGHT COVER, MOLDED WHITE PLASTIC



**Fig. 137**

#### ORDERING INFORMATION



**Fig. 140**

Dimensions Inches	Display Pkg. - 10 Cards 1 Pc. per Card	OEM Bulk Pkg. 100 Pcs.	Screw Size	Weight Ounces
1-3/8 x 5/8	137 DP BLK	137 000 BLK	6 R.H.	1/2
1-3/8 x 5/8	140 DP NYN	140 000 NYN	6 R.H.	1/2

### FIGS. 1087 & 1090 - VAPOR PROOF LIGHT FIXTURES

**SATIN FINISH DIE CAST ALUMINUM WITH GLASS GLOBES. INTEGRAL JUNCTION BOX WITH FOUR 1/2 INCH I.P.S. FITTINGS.**

**FIG. 1087, CEILING MOUNT  
FIG. 1090, BULKHEAD MOUNT**

**MEDIUM SCREW SOCKET FOR BULBS UP TO 100 WATTS. BULB NOT INCLUDED.**

#### ORDERING INFORMATION



**Fig. 1090**



**Fig. 1087**

O.D. Box Inches	Length Overall Inches	Projection Inches	Standard Pkg. - 1 Pc.	Bolt Size	Weight Pounds
3-3/4	9-1/2	---	1087 000 ALU	1/4	3
3-3/4	10	7	1090 000 ALU	1/4	3-1/4



**LISTED BY  
UNDERWRITERS  
LABORATORIES**

*Note: These fixtures are listed in accordance with U.L. Standard 57, for enclosed gasketed fixtures Not evaluated for use in hazardous or explosive atmospheres.*

Spare Guards, Cat. Nos. 1087 000 99A and 1090 000 99A.  
Spare Sockets, Cat. Nos. 1087 000 99B and 1090 000 99B.

Spare Globes, Cat. Nos. 1087 000 99C and 1090 000 99C.



## UTILITY LIGHTS



### FIG. 1044 - FIXED UTILITY LIGHT

**NO. 1 SUPPLIED WITH 1/4" SPADE CONNECTORS**

**NO. 2 SUPPLIED WITH 7" WIRE LEADS**

**COMPLETE WITH 12 VOLT, 3 WATT BULB.  
SNAP-ON FRONT COVER CONCEALS MOUNTING SCREWS.**

**MOLDED PLASTIC, BLACK OR WHITE  
INSTALLS IN A 1-3/4" DIAMETER HOLE.**



**FIG. 1044**

#### ORDERING INFORMATION

Color	Dimensions Inches	Depth Inches	Display Pkg. - 10 Cards 1 Pc. per Card	OEM Bulk Pkg. 100 Pcs.	Weight Ounces
Black	2-1/4 x 2-1/4	15/16	1044 DP1 BLK	1044 001 BLK	1
Black	2-1/4 x 2-1/4	15/16	1044 DP2 BLK	1044 002 BLK	1
White	2-1/4 x 2-1/4	15/16	1044 DP1 WHT	1044 001 WHT	1
White	2-1/4 x 2-1/4	15/16	1044 DP2 WHT	1044 002 WHT	1

Screw Size, No. 6.

Spare Bulb, Cat. No. 1044 000 99A.



### FIG. 1064 - FIXED UTILITY LIGHT

**NO. 1 SUPPLIED WITH 1/4" SPADE CONNECTORS**

**NO. 2 SUPPLIED WITH 7" WIRE LEADS**

**COMPLETE WITH 12 VOLT, 3 WATT BULB.**

**MOLDED PLASTIC, BLACK OR WHITE  
INSTALLS IN A 1-3/4" DIAMETER HOLE.**



**FIG. 1064**

#### ORDERING INFORMATION

Color	Dimensions Inches	Depth Inches	Display Pkg. - 10 Cards 1 Pc. per Card	OEM Bulk Pkg. 100 Pcs.	Weight Ounces
Black	2-1/4 x 2-1/4	15/16	1064 DP1 BLK	1064 001 BLK	1
Black	2-1/4 x 2-1/4	15/16	1064 DP2 BLK	1064 002 BLK	1
White	2-1/4 x 2-1/4	15/16	1064 DP1 WHT	1064 001 WHT	1
White	2-1/4 x 2-1/4	15/16	1064 DP2 WHT	1064 002 WHT	1

Screw Size, No. 6.

Spare Bulb, Cat. No. 1044 000 99A.





## SPREADER LIGHTS



### FIG. 1040 - ADJUSTABLE SPREADER LIGHT

**COMPLETE WITH 12 VOLT, 24 OR 32 VOLT SEALED BEAM UNIT.**

**MOLDED BLACK PLASTIC BODY  
CHROME PLATED BRASS MOUNTING BRACKET**



**FIG. 1040**

#### ORDERING INFORMATION

Voltage	Dimensions			Display Pkg. 1 Pc. per Card	Cards per Pkg.	OEM Bulk Pkg. 10 Pcs.	Weight Pounds
	O.D. Inches	Depth Inches	Bracket Inches				
12	4-1/2	4-1/2	4-1/2 x 1	1040 DP1 12V	5	1040 001 12V	1-1/2
24	4-1/2	4-1/2	4-1/2 x 1	1040 DP2 24V	2	1040 002 24V	1-1/2
32	4-1/2	4-1/2	4-1/2 x 1	1040 DP3 32V	2	1040 003 32V	1-1/2

Screw Size, No. 12 R.H.

Spare Sealed Beam Unit (12 Volt), Cat. No. 432 001 12V.

Spare Sealed Beam Unit (24 Volt), Cat. No. 432 002 24V.

Spare Sealed Beam Unit (32 Volt), Cat. No. 432 003 32V.



### FIG. 280 - ADJUSTABLE SPREADER LIGHT

**COMPLETE WITH 12 VOLT, 24 OR 32 VOLT SEALED BEAM UNIT.**

**CHROME PLATED BRASS**



**FIG. 280**

#### ORDERING INFORMATION

Voltage	Dimensions			Display Pkg. 1 Pc. per Card	Cards per Pkg.	OEM Bulk Pkg. 10 Pcs.	Weight Pounds
	O.D. Inches	Depth Inches	Bracket Inches				
12	4-5/8	2-1/2	5-3/8 x 3/4	280 DP1 12V	5	280 001 12V	1-1/8
24	4-5/8	2-1/2	5-3/8 x 3/4	280 DP2 24V	2	280 002 24V	1-1/8
32	4-5/8	2-1/2	5-3/8 x 3/4	280 DP3 32V	2	280 003 32V	1-1/8

Screw Size, No. 12 R.H.

Spare Sealed Beam Unit (12 Volt), Cat. No. 432 001 12V.

Spare Sealed Beam Unit (24 Volt), Cat. No. 432 002 24V.

Spare Sealed Beam Unit (32 Volt), Cat. No. 432 003 32V.



### FIG. 265 - FIXED SPREADER LIGHT

**COMPLETE WITH 12 VOLT, 10 WATT BULB**

**CHROME PLATED BRONZE**



**FIG. 265**

#### ORDERING INFORMATION

O.D. Inches	Depth Inches	Display Pkg. - 5 Pcs. 1 Pc. per Pkg.	OEM Bulk Pkg. 10 Pcs.	Screw Size	Weight Ounces
2-3/4	1-3/8	265 DP CHR	265 000 CHR	6	5

Spare Bulbs (2 per card), Cat. No. 70 DP0 CLR.

Spare Socket Assembly, Cat. No. 265 000 99A.

Spare Lens with O-Ring, Cat. No. 284 DP CLR.



## BULKHEAD LIGHTS

### FIG. 217 - BULKHEAD LIGHT FIXTURES

**FOR SYSTEMS UP TO 50 VOLTS.  
MEDIUM SCREW SOCKET, TURN SWITCH**

**CHROME PLATED ZINC**

#### ORDERING INFORMATION

Dimensions Base Inches	Projection Less Lamp Inches	Display Pkg. - 5 Cards 1 Pc. per Card	Screw Size	Weight Ounces
2-1/2 x 1-3/4	2-5/8	217 DP CHR	6 R.H.	8

Spare Bulb Socket with Switch, Cat. No. 223.



FIG. 217



### FIG. 450 - BULKHEAD LIGHT FIXTURES

**FOR SYSTEMS UP TO 50 VOLTS.  
MEDIUM SCREW SOCKET, TURN SWITCH  
BULB NOT INCLUDED**

**CAST BRONZE  
POLISHED OR CHROME PLATED**

#### ORDERING INFORMATION

Dimensions Base Inches	Projection Less Lamp Inches	Polished Bronze Display Pkg. - 5 Pcs.	Chrome Plated Bronze Display Pkg. - 5 Pcs.	Screw Size	Weight Ounces
2-1/2 x 2-1/2	2-1/2	450 DP POL	450 DP CHR	8 R.H.	11

Spare Bulb Socket with Switch, Cat. No. 223.



FIG. 450



### FIG. 1303 - BULKHEAD LIGHT FIXTURES

**FOR SYSTEMS UP TO 50 VOLTS.**

**SIZE NO. 1 HAS DOUBLE CONTACT BAYONET SOCKET.  
WILL ACCOMMODATE A BULB UP TO 24 WATTS.**

**SIZE NO. 2 HAS MEDIUM SCREW SOCKET.  
WILL ACCOMMODATE A BULB UP TO 40 WATTS.**

**MOLDED PLASTIC, BLACK OR WHITE**

#### ORDERING INFORMATION

Dimensions Wall Plated Inches	Normal Projection Inches	Length Shade Inches	Black Std. Pkg. - 1 Pc. OEM Pkg. - 50 Pcs.	White Std. Pkg. - 1 Pc. OEM Pkg. - 50 Pcs.	Screw Size	Weight Ounces
4-1/2 x 3-1/4	4-3/8	3	1303 001 BLK	1303 001 WHT	8	3
4-1/2 x 3-1/4	5	4-1/2	1303 002 BLK	1303 002 WHT	8	5

Spare Switch, Cat. No. 701 DP.



FIG. 1303





**JANUARY 31, 1977 THE U.S.C.G. PUBLISHED SAFETY STANDARDS FOR MARINE ELECTRICAL SYSTEMS. THESE STANDARDS COVER SUCH TECHNICAL DETAILS AS:**

- **BATTERIES AND ASSOCIATED CONDUCTORS**
  
- **CONDUCTOR SIZE AND AMPACITY**
  
- **STRAIN RELIEF AND PULL TESTS**
  
- **TERMINATION REQUIREMENTS**
  
- **OVERCURRENT PROTECTION**
  
- **IGNITION PROTECTION**
  
- **GROUNDING**
  
- **INSULATION**

A particular electrical component may be affected by some or all of the above categories. Those categories related to product design have been complied with, however, many additional details must be considered by the installer of the equipment as well in order to achieve compliance with this standard. It is suggested that the actual standard be familiarized when installing equipment. Perhaps one of the most critical requirements is ignition protection. A product that is marked "Ignition Protected" can be used in that area of a boat that is not isolated from a gasoline fuel vapor source. Refer to the actual standard for a determination of what parts of a boat require Ignition Protected products. If a product is not plainly marked "Ignition Protected" then assume it is not.

**FOR DETAILS ON ALL OF THE ABOVE, OBTAIN THE FOLLOWING:  
U.S.C.G. SAFETY STANDARDS FOR ELECTRICAL SYSTEMS  
CFR TITLE 33, CHAPTER 1, SUBCHAPTER S, PART 183, SUBPART I.**



## BATTERY SELECTOR SWITCHES



### IGNITION PROTECTED

STANDARD FEATURES INCLUDE A MAKE BEFORE BREAK DESIGN, FOR USE WITH TWO OR MORE BATTERIES AND SINGLE OR DUAL ENGINE SYSTEMS\*. THEY PERMIT SELECTION BETWEEN BATTERIES FOR STARTING AND CHARGING OR OPERATION OF BOTH BATTERIES IN PARALLEL. THEY ALLOW THE ADDITION OF AN EXTRA BATTERY FOR USE WITH ACCESSORIES. THE "OFF" POSITION ALSO ACTS AS AN EMERGENCY DISCONNECT IN THE EVENT OF AN ELECTRICAL PROBLEM. IN ADDITION SOME MODELS OFFER UNIQUE OPTIONS SUCH AS A KEYLOCK FOR EXTRA THEFT PROTECTION.

PROTECTED BY THE FOLLOWING U.S. PATENTS; DESIGN 260,637 - 4,280,028 - 4,424,424

**SURFACE MOUNT, RED PLASTIC HOUSING WITH LARGE BLACK PLASTIC KNOB. INCORPORATES AN IMPROVED DESIGN TO PROTECT THE COPPER CONTACTS AND BRASS TERMINALS USED AS ELECTRICAL CONNECTIONS.**

**FOR USE WITH SYSTEMS UNDER 50 VOLTS.  
CAPACITY - 250 AMPS CONTINUOUS, 360 AMPS INTERMITTENT.**

### ORDERING INFORMATION

Features:	Display Pkg. - 5 Pkgs. 1 Pc. per Pkg.	OEM Bulk Pkg. 25 Pcs.	Diameter Inches	Depth Inches	Weight Pounds
Standard	8501 DP	8501	5-1/4	2-5/8	1
With Keylock	8502 DP	8502	5-1/4	2-5/8	1



Fig. 8501



Fig. 8502

\*For Dual Engine Systems, two switches are required.

### ALTERNATOR FIELD DISCONNECT MODELS



IN ADDITION TO THE STANDARD FEATURES LISTED ABOVE THE ADVANTAGE THESE MODELS FEATURE IS THAT THEY WILL PREVENT DAMAGE TO THE ALTERNATOR\* IF ACCIDENTALLY SWITCHED TO THE "OFF" POSITION WHILE THE ENGINE IS RUNNING.

### ORDERING INFORMATION

Features:	Display Pkg. - 5 Pkgs. 1 Pc. per Pkg.	OEM Bulk Pkg. 25 Pcs.	Diameter Inches	Depth Inches	Weight Pounds
Standard	8503 DP	8503	5-1/4	2-5/8	1
With Keylock	8504 DP	8504	5-1/4	2-5/8	1



Fig. 8503

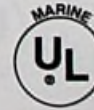

Fig. 8504

\*When used with Non-Unitized Alternators, these models will interrupt the field current (reducing the possibility of damage) if turned "OFF" with the engine running.



## MAIN BATTERY SWITCHES



### IGNITION PROTECTED

THESE UNITS ARE THE SAME BASIC DESIGN AND CONSTRUCTION AS OUR 8500 SERIES, EXCEPT THEY ARE OFFERED AS MAIN DISCONNECT SWITCHES.

FOR USE WITH SYSTEMS UNDER 50 VOLTS.  
CAPACITY - 250 AMPS CONTINUOUS, 360 AMPS INTERMITTENT.

PROTECTED BY THE FOLLOWING U.S. PATENTS; DESIGN 260,637 - 4,280,028 - 4,424,424

### ORDERING INFORMATION

Features:	Display Pkg. - 5 Pkgs. 1 Pc. per Pkg.	OEM Bulk Pkg. 25 Pcs.	Diameter Inches	Depth Inches	Weight Pounds
Standard	9601 DP	9601	5-1/4	2-5/8	1
With Keylock	9602 DP	9602	5-1/4	2-5/8	1



Fig. 9601



Fig. 9602

### ALTERNATOR FIELD DISCONNECT MODELS



IN ADDITION TO THE STANDARD FEATURES THE ADVANTAGE THESE MODELS FEATURE IS THAT THEY WILL PREVENT DAMAGE TO THE ALTERNATOR\* IF ACCIDENTALLY SWITCHED TO THE "OFF" POSITION WHILE THE ENGINE IS RUNNING.

### ORDERING INFORMATION

Features:	Display Pkg. - 5 Pkgs. 1 Pc. per Pkg.	OEM Bulk Pkg. 25 Pcs.	Diameter Inches	Depth Inches	Weight Pounds
Standard	9603 DP	9603	5-1/4	2-5/8	1
With Keylock	9604 DP	9604	5-1/4	2-5/8	1

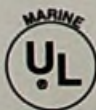

Fig. 9603

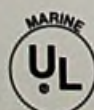

Fig. 9604

\*When used with Non-Unitized Alternators, these models will interrupt the field current (reducing the possibility of damage) if turned "OFF" with the engine running.



## BATTERY SELECTOR SWITCHES

**FIG. 8603 - HEAVY DUTY BATTERY SELECTOR SWITCH**



**IGNITION PROTECTED**

**MAKE BEFORE BREAK DESIGN, FOR USE WITH TWO OR MORE BATTERIES AND SINGLE OR DUAL ENGINES. ALTERNATOR FIELD DISCONNECT TO PREVENT DAMAGE TO ALTERNATOR IF ACCIDENTALLY SWITCHED TO THE "OFF" POSITION WHILE ENGINE IS RUNNING.**

**FIBER-REINFORCED POLYCARBONATE BODY  
1/2 INCH DIAMETER BRASS BATTERY TERMINALS  
FOR USE WITH SYSTEMS UNDER 50 VOLTS.  
CAPACITY - 380 AMPS CONTINUOUS, 850 AMPS INTERMITTENT.**

### ORDERING INFORMATION

Dimensions Face Inches	Depth Inches	Display Pkg. - 2 Pkgs. 1 Pc. per Pkg.	Weight Pounds
5-1/4 x 5-1/4	3-3/8	8603 DP	3



**Fig. 8603**

## BATTERY SELECTOR SWITCHES WITH REMOTE INDICATOR PANEL



**IGNITION PROTECTED**

**THESE UNITS HAVE THE SAME BASIC FEATURES AND CONSTRUCTION AS FIGS. 8501 & 8502 PLUS PROVISIONS FOR USE WITH A REMOTE INDICATOR PANEL.**

**FOR USE WITH SYSTEMS UNDER 50 VOLTS.  
INDICATOR PANEL SUPPLIED WITH 12 VOLT LAMPS ONLY  
CAPACITY - 250 AMPS CONTINUOUS, 360 AMPS INTERMITTENT**

**PROTECTED BY THE FOLLOWING U.S. PATENTS; DESIGN 260,637 - 4,280,028 - 4,424,424**

### ORDERING INFORMATION

Features:	Display Pkg. - 5 Pkgs. 1 Pc. per Pkg.	OEM Bulk Pkg. 25 Pcs.	Diameter Inches	Depth Inches	Weight Pounds
Standard	8505 DP	8505	5-1/4	2-5/8	1
With Keylock	8506 DP	8506	5-1/4	2-5/8	1



**Fig. 8505**

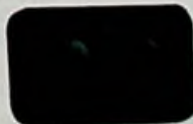
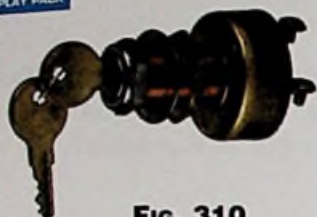

**Fig. 8506**

*These Switches are Designed to Meet Federal Specification-Ambulance (KKK-A-1822B).*



## SWITCHES



**Fig. 310**

### Fig. 310 - Ignition Starter Switch

**3 POSITION: OFF-IGNITION/RUN-START.**  
**RATED FOR 15 AMPS AT 12, 24 AND 32 VOLTS.**  
**AUTOMATICALLY RETURNS FROM START TO RUN POSITION.**  
**CHROME PLATED BRASS FACE NUT WITH PLAIN BRASS BODY**

#### ORDERING INFORMATION

For Maximum Dash Thickness Inches	Diameter Neck Inches	Length Overall Inches	Display Pkg. - 10 Cards 1 Pc. per Card	Weight Ounces
1	13/16	2-3/4	310 DP CHR	4-1/2



**Fig. 105**

### Fig. 105 - Push-Pull Switch

**2 POSITION: OFF-ON.**  
**RATED FOR 15 AMPS AT 12, 24 AND 32 VOLTS.**  
**CHROME PLATED BRASS FACE NUT AND PLASTIC KNOB WITH PLAIN BRASS BODY**

#### ORDERING INFORMATION

For Maximum Dash Thickness Inches	Diameter Neck Inches	Length Overall Inches	Display Pkg. - 10 Cards 1 Pc. per Card	OEM Bulk Pkg. 50 Pcs.	Weight Ounces
1	3/8	3	105 DP1 CHR	105 001 CHR	2-1/2

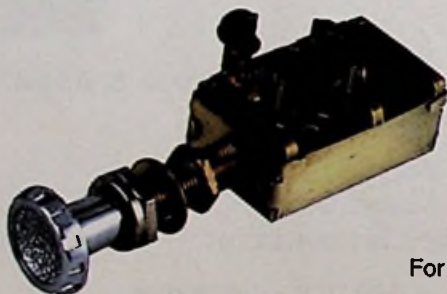

**Fig. 366**

### Fig. 366 - Push-Pull Switch

**3 POSITION: 2 CIRCUIT, OFF-ON-ON.**  
**RATED FOR 15 AMPS AT 12, 24 AND 32 VOLTS.**  
 For use with Combination Masthead/All-Round Lights together with Running Lights. Second "On" Position turns off Running Lights and turns on both compartments of Masthead/All-Round Light.

**CHROME PLATED BRASS FACE NUT AND PLASTIC KNOB WITH PLAIN BRASS BODY**

#### ORDERING INFORMATION

For Maximum Dash Thickness Inches	Diameter Neck Inches	Length Overall Inches	Display Pkg. - 10 Cards 1 Pc. per Card	Weight Ounces
1	3/8	3-3/4	366 DP CHR	3-1/4



**Fig. 381**

### Fig. 381- Push-Pull Switch

**3 POSITION: OFF-ON-ON.**  
**RATED FOR 15 AMPS AT 12, 24 AND 32 VOLTS.**

First "On" Position Energizes One Terminal  
 Second "On" Position Energizes Both Terminals

**CHROME PLATED BRASS FACE NUT AND PLASTIC KNOB WITH PLAIN BRASS BODY**

#### ORDERING INFORMATION

For Maximum Dash Thickness Inches	Diameter Neck Inches	Length Overall Inches	Display Pkg. - 10 Cards 1 Pc. per Card	Weight Ounces
1	3/8	3-3/4	381 DP CHR	3-1/4

**Important Note: None of the above Switches are Ignition Protected. See Page 68.**



## SWITCHES

**FIG. 255 - MOMENTARY SWITCH**

**SINGLE POLE.  
RATED FOR 15 AMPS AT 12, 24 AND 32 VOLTS.  
CHROME PLATED BRASS BUTTON AND FACE NUT  
WITH PLAIN BRASS BODY**

**ORDERING INFORMATION**

For Maximum Dash Thickness Inches	Diameter Neck Inches	Length Overall Inches	Display Pkg. - 10 Cards 1 Pc. per Card	OEM Bulk Pkg. 50 Pcs.	Weight Ounces
7/8	5/8	2-3/4	255 DP CHR	255 000 CHR	2-1/2



**FIG. 255**

**FIG. 306 - MOMENTARY SWITCH**

**SINGLE POLE.  
RATED FOR 15 AMPS AT 12, 24 AND 32 VOLTS.  
CHROME PLATED BRASS BUTTON WITH WEATHER  
RESISTANT COVER AND PLAIN BRASS BODY**

**ORDERING INFORMATION**

For Maximum Dash Thickness Inches	Diameter Neck Inches	Length Overall Inches	Display Pkg. - 10 Cards 1 Pc. per Card	OEM Bulk Pkg. 50 Pcs.	Weight Ounces
1	5/8	2-3/4	306 DP CHR	306 000 CHR	3



**FIG. 306**

**FIG. 701 - PUSH BUTTON SWITCH**

**PUSH-ON, PUSH-OFF.  
RATED FOR 4 AMPS AT 12, 24 AND 32 VOLTS.  
BLACK PLASTIC WITH WEATHER RESISTANT COVER**

**ORDERING INFORMATION**

Maximum Thickness of Panel	Diameter Neck Inches	Display Pkg. - 10 Cards 1 Pc. per Card	Weight Ounces
1/8	3/8	701 DP	1/2



**FIG. 701**



**FIG. 703 - PUSH BUTTON SWITCH**

**PUSH-ON, PUSH-OFF.  
RATED FOR 2 AMPS AT 12, 24 AND 32 VOLTS.  
NICKEL PLATED BUTTON WITH BRUSHED ALUMINUM FACE NUT  
AND WEATHER RESISTANT COVER**

**ORDERING INFORMATION**

Maximum Thickness of Panel	Diameter Neck Inches	Display Pkg. - 10 Cards 1 Pc. per Card	Weight Ounces
1/8	3/8	703 DP NKL	1/2



**FIG. 703**



**Important Note: None of the above Switches are Ignition Protected. See Page 68.**





**FIG. 514**

**FIG. 514 - TOGGLE SWITCH**

**SINGLE POLE, SINGLE THROW (OFF-ON).  
RATED FOR 6 AMPS AT 12, 24 AND 32 VOLTS.**

**NICKEL PLATED BRASS TOGGLE WITH  
CHROME PLATED FACE NUT**

**ORDERING INFORMATION**

Maximum Thickness of Panel Inches	Diameter Neck Inches	Display Pkg. - 10 Cards 1 Pc. per Card	Weight Ounces
5/16	7/16	514 DP	3/4



**FIG. 688**

**FIG. 688 - TOGGLE SWITCH**

**SINGLE POLE, SINGLE THROW (OFF-ON).  
RATED FOR 20 AMPS AT 12, 24 AND 32 VOLTS.**

**NICKEL PLATED BRASS TOGGLE WITH  
CHROME PLATED FACE NUT**

**ORDERING INFORMATION**

Maximum Thickness of Panel Inches	Diameter Neck Inches	Display Pkg. - 10 Cards 1 Pc. per Card	Weight Ounces
3/16	7/16	688 DP NKL	1

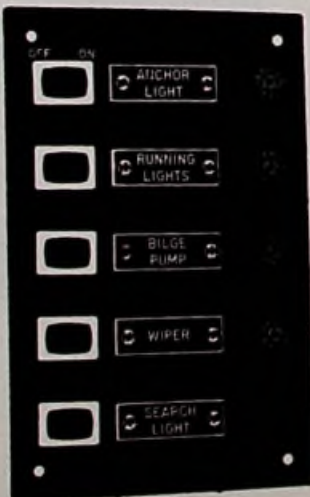

**FIG. 517**

**FIG. 517 - SWITCH PANEL**

**BLACK PLASTIC**

**RATED FOR 10 AMPS AT 12, 24 AND 32 VOLTS.  
FOR 1/4" x 1-1/4" FUSES.**

**COMPLETE WITH ROCKER SWITCHES,  
NAME PLATES AND LOW PROFILE  
FUSE HOLDERS FOR 1/4" x 1-1/4" FUSES.**

**WILL MOUNT ON CURVED OR FLAT SURFACES,  
TEXTURED FINISH,  
ENGRAVED LETTERING**

**ORDERING INFORMATION**

Dimensions Inches	Display Pkg. - 5 Cards 1 Pc. per Card	Weight Ounces
6-1/2 x 4-1/2	517 DP BLK	8

Screw Size #6

Spare Rocker Switches, Cat. No. 531 DP.  
Spare Fuse Holder Cap, Cat. No. 558 DP.  
Spare Fuse Holders, Cat. No. 532 DP.

**Important Note: None of the above Switches are Ignition Protected. See Page 68.**



## FUSE PANELS

### FIG. 626 - FUSE PANELS

**RATED FOR 20 AMPS AT 12, 24 AND 32 VOLTS.  
FOR 1/4" x 1-1/4" FUSES**

**MOLDED PLASTIC BASE WITH BRASS HARDWARE**

#### ORDERING INFORMATION

Number of Gangs	Display Pkg. - 5 Bags 1 Pc. per Bag	Dimensions Inches	Weight Ounces
3	626 003 DP	2-1/4 x 2-7/16 x 3/16	2
4	626 004 DP	3 x 2-7/16 x 3/16	2-1/4
5	626 005 DP	3-3/4 x 2-7/16 x 3/16	2-1/2
6	626 006 DP	4-1/2 x 2-7/16 x 3/16	2-3/4

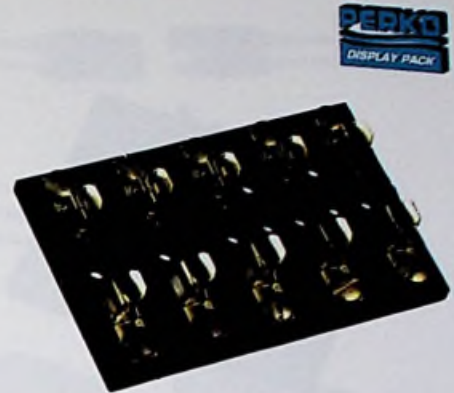

FIG. 626

### FIG. 629 - FUSE PANELS

**RATED FOR 20 AMPS AT 12, 24 AND 32 VOLTS.  
FOR 1/4" x 1-1/4" FUSES**

**SINGLE BUS BAR  
MOLDED PLASTIC BASE WITH BRASS HARDWARE**

#### ORDERING INFORMATION

Number of Gangs	Display Pkg. - 5 Bags 1 Pc. per Bag	Dimensions Inches	Weight Ounces
4	629 004 DP	3 x 2-7/16 x 3/16	2
6	629 006 DP	4-1/2 x 2-7/16 x 3/16	3
8	629 008 DP	6 x 2-7/16 x 3/16	3
12	629 012 DP	9 x 2-7/16 x 3/16	6-1/2

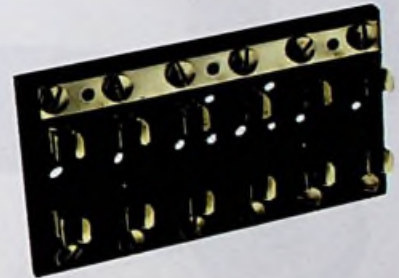

FIG. 629

### FIG. 694 - FUSE PANELS

**RATED FOR 20 AMPS AT 12, 24 AND 32 VOLTS.  
FOR 1/4" x 1-1/4" FUSES**

**INCLUDES CENTER CLIP FOR SPARE FUSE.  
MOLDED PLASTIC BASE WITH BRASS HARDWARE**

#### ORDERING INFORMATION

Number of Gangs	Display Pkg. - 5 Bags 1 Pc. per Bag	Dimensions Inches	Weight Ounces
2	694 DP	2-7/16 x 1-1/2 x 3/16	1-1/2

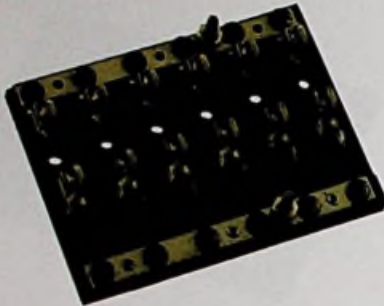

FIG. 694

**Important Note: All of the Above Items Conform to U.S.C.G. Electrical Standards. See Page 68.**



## TERMINAL BLOCKS & FUSEHOLDER



**Fig. 647**

### FIG. 647 - COMBINATION FUSE & TERMINAL BLOCK

**RATED FOR 20 AMPS AT 12, 24 AND 32 VOLTS.  
FOR 1/4" x 1-1/4" FUSES**

**WITH BINDING POSTS  
MOLDED PLASTIC BASE WITH BRASS HARDWARE**

#### ORDERING INFORMATION

Number of Gangs	Display Pkg. - 5 Bags 1 Pc. per Bag	Dimensions Inches	Weight Ounces
4	647 004 DP	3 x 3-5/16 x 3/16	3-1/2
6	647 006 DP	4-1/2 x 3-5/16 x 3/16	5
8	647 008 DP	6 x 3-5/16 x 3/16	7
12	647 012 DP	9 x 3-5/16 x 3/16	11



**Fig. 627**

### FIG. 627 - TERMINAL BLOCKS

**RATED FOR 30 AMPS AT 12, 24 AND 32 VOLTS.**

**MOLDED PLASTIC BASE WITH BRASS HARDWARE**

#### ORDERING INFORMATION

Number of Gangs	Display Pkg. - 5 Bags 1 Pc. per Bag	Dimensions Inches	Weight Ounces
2	627 002 DP	1-1/2 x 1-1/2 x 3/16	1
4	627 004 DP	3 x 1-1/2 x 3/16	2
6	627 006 DP	4-1/2 x 1-1/2 x 3/16	2-1/4



**Fig. 786**

### FIG. 786 - IN-LINE FUSEHOLDER

**RATED FOR 20 AMPS AT 12, 24 AND 32 VOLTS.  
FOR 1/4" x 1-1/4" FUSES**

**COMPLETE WITH 12 VOLT, 20 AMP FUSE  
AND 7-1/2 INCH WIRE LEAD.**

**MOLDED PLASTIC**

#### ORDERING INFORMATION

Length Inches	Diameter Inches	Display Pkg. - 10 Bags 1 Pc. per Bag	Weight Ounces
2-1/8	11/16	786 DP	3/4



**Important Note: All of the Above Items Conform to A.B.Y.C. Electrical Standards. See Page 68.**



## CONNECTIONS & CABLE OUTLETS



### FIG. 720 - FLAT LINE CONNECTORS

**RATED FOR 15 AMPS AT 12, 24 AND 32 VOLTS.**

**POLARIZED**

**BOTH SIDES HAVE 12 INCH, 18 GAUGE COLOR CODED WIRE LEADS**

**MOLDED PLASTIC BODIES WITH BRASS CONTACTS**

#### ORDERING INFORMATION

Number of Poles	Display Pkg. - 5 Bags 1 Pc. per Bag	Width Inches	Weight Ounces
2	720 DP2	5/8	1
3	720 DP3	7/8	1-1/2
4	*720 DP4	1-1/8	2

\*All contacts are shrouded.



FIG. 720-2

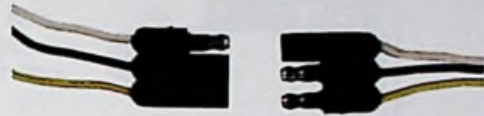

FIG. 720-3



FIG. 720-4 SHROUDED

### FIGS. 1189 & 1190 - WATERTIGHT DECK CONNECTIONS

**RATED FOR 15 AMPS AT 12, 24 AND 32 VOLTS.**

**POLARIZED DOUBLE CONTACT CONNECTOR**

**FIG. 1189, CHROME PLATED BRASS**

**FIG. 1190, CHROME PLATED ZINC**

**FLANGE GASKET WITH INTEGRAL WATERPROOF CAP FOR BASE WHEN PLUG IS REMOVED.**

#### ORDERING INFORMATION

Diameter Inches	Height Inches	Display Pkg. - 10 Cards 1 Pc. per Card	OEM Bulk Pkg. 50 Pcs.	Screw Size	Weight Ounces
1-5/8	1-3/16	1189 DP CHR	1189 000 CHR	4	2-1/2
1-5/8	1-3/16	1190 DP CHR	1190 000 CHR	4	2-1/2

Spare Connector with Cover, Cat. No. 1189 DP 99A.

Spare Connector Only, Cat. No. 42.

*Note: These Items Are Not Ignition Protected.*



FIG. 1189 -

**CHROME PLATED BRASS**

FIG. 1190 -

**CHROME PLATED ZINC**

*Important Note: All of the Above Items Conform to U.S.C.G. Electrical Standards. See Page 68.*

### FIGS. 424 & 1191 - WATERTIGHT CABLE OUTLETS

**FOR 5/16 INCH O.D. CABLE**

**FIG. 424, CHROME PLATED BRASS**

**FIG. 1191, CHROME PLATED ZINC**

**EQUIPPED WITH RUBBER GROMMET FOR WATERTIGHT PASSAGE OF CABLE.**

#### ORDERING INFORMATION

Diameter Base Inches	Display Pkg. - 10 Cards 1 Pc. per Card	Screw Size	Weight Ounces
1-1/4	424 DP CHR	4	1
1-1/4	1191 DP CHR	4	1



FIG. 424 - CHROME PLATED BRASS

FIG. 1191 - CHROME PLATED ZINC

## CABLE STRAPS & LINE SUPPORT CLIPS



### FIG. 121 - BRASS CABLE STRAP

FOR CABLE, TUBING, CONTROL WIRE, ETC.

#### ORDERING INFORMATION



Fig. 121

I.D. Inches	Length Inches	Display Pkg. - 10 Bags 10 Pcs. per Bag
1/8	1-7/16	121 DP1 PLB
3/16	1-3/8	121 DP2 PLB
1/4	1-5/16	121 DP3 PLB
5/16	1-3/16	121 DP4 PLB
3/8	1-5/8	121 DP5 PLB
7/16	1-5/8	121 DP6 PLB
1/2	1-1/2	121 DP7 PLB
5/8	1-3/4	121 DP8 PLB
3/4	1-7/8	121 DP9 PLB



Width all sizes - 1/2 inch.

Note: This Item Conforms to U.S.C.G. Fuel Standards



### FIG. 196 - PLASTIC CABLE STRAP

BLACK PLASTIC, ULTRA-VIOLET STABILIZED FOR WEATHER RESISTANCE.  
ELIMINATES THE NEED FOR INSULATING CUSHION.

#### ORDERING INFORMATION

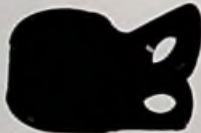

Fig. 196

I.D. Inches	Display Pkg. - 10 Bags 10 Pcs. per Bag	OEM Pkg. 500 Pcs.
3/16	196 DP1	196 001
1/4	196 DP2	196 002
5/16	196 DP3	196 003
3/8	196 DP4	196 004
1/2	196 DP5	196 005
5/8	196 DP6	196 006
3/4	196 DP7	196 007



Width all sizes - 1/2 inch.

Note: This Item Conforms to U.S.C.G. Electric Standards



### FIGS. 163, 164, 165 - LINE SUPPORT CLIPS

ALUMINUM WITH SYNTHETIC RUBBER CUSHION



FIG. 163  
SINGLE

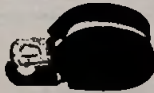

FIG. 164  
DOUBLE



FIG. 165  
TRIPLE

#### ORDERING INFORMATION

For O.D. Line Inches	Width Inches	Single Display Pkg. - 10 Bags 10 Pcs. per Bag	Double Display Pkg. - 10 Bags 10 Pcs. per Bag	Triple Display Pkg. - 10 Bags 10 Pcs. per Bag
3/16	3/8	163 DP1 ALU	164 DP1 ALU	-----
1/4	3/8	163 DP2 ALU	164 DP2 ALU	-----
5/16	1/2	163 DP3 ALU*	164 DP3 ALU	165 DP3 ALU
3/8	1/2	163 DP4 ALU*	164 DP4 ALU	165 DP4 ALU
1/2	1/2	163 DP5 ALU	164 DP5 ALU*	165 DP5 ALU*
5/8	1/2	163 DP6 ALU*	-----	-----



\*OEM Package - 500 Pcs. Replace "DP" with "00" When Ordering.

Note: This Item Conforms to U.S.C.G. Electric & Fuel Standards



## LIGHT BULBS

**FIG. 337 - DOUBLE CONTACT BAYONET BASE BULB**



**CLEAR**

**ORDERING INFORMATION**

Nominal Voltage	Wattage	Amps	Display Pkg. 5 Cards	Bulbs per Card	Bulb Diameter Inches	Mfg. Lamp No.
12	7	.58	337 011 DP	2	3/4	90
12	11	.94	337 012 DP	2	3/4	1004
12	17	1.44	337 013 DP	2	1	1142
24	15	.63	337 014 DP	1	1	306
32	12	.37	337 018 DP	1	3/4	624
32	14	.65	337 019 DP	1	1	1228
32	20	.61	337 020 DP	1	1	1692
32	24	.74	337 021 DP	1	1-3/8	1054
120	15	---	337 023 DP	2	7/8	15T7



**FIG. 337**



**FIG. 67, 69, 70, 71, & 72 - DOUBLE ENDED FESTOON BULBS**



**CLEAR**

**RUST-PROOF NICKEL PLATED BRASS CAPS**

**ORDERING INFORMATION**

Nominal Voltage	Wattage	Amps	Display Pkg. - 5 Cards 2 Bulbs per Card	Bulb Diameter Inches	Bulb Length Inches
12	10	.83	69 DP CLR	3/8	1-5/8
12	10	.74	70 DP0 CLR	3/8	1-11/16
12	15	.97	70 DP1 CLR	9/16	1-11/16
12	10	.80	71 DP CLR	3/8	1-1/8
24	10	.42	67 DP1 CLR	3/8	1-11/16
24	18	.75	67 DP2 CLR	9/16	1-11/16
24	10	.40	72 DP1 CLR	3/8	1-1/8
32	13	.40	70 DP2 CLR	3/8	1-5/8



**FIG. 67**  
**FIG. 69**  
**FIG. 70**  
**FIG. 71**  
**FIG. 72**



**FIG. 340 - MEDIUM SCREW BASE BULB**



**FROSTED**

**ORDERING INFORMATION**

Nominal Voltage	Wattage	Amps	Standard Pkg. 6 Bulbs	Type	L.C.L. Inches	Mfg. Lamp No.
12	15	1.25	340 005 FRD	A-17	2-3/8	15-A
12	25	2.08	340 006 FRD	A-19	2-9/16	25-A
12	50	4.16	340 007 FRD	A-21	3-7/16	50-A21
32	15	.47	340 011 FRD	A-17	2-3/8	15-A
32	25	.78	*340 012 FRD	A-19	2-9/16	25-A
32	50	1.56	*340 013 FRD	A-21	3-7/16	50-A21



**FIG. 340**



\*Standard Pkg. - 2 Bulbs

**Note: High Power Bulbs and Sealed Beam Units for Searchlights, See Searchlight Section.**  
**ELECTRIC BULBS ARE NOT RETURNABLE. ORDER CAREFULLY**

Note: Figs. 162 & 349 Conform to A.B.Y.C. Standard A-23 in Accordance with the '72 COLREGS and U.S. Inland Rules for Use on Vessels Under 5 Meters (16.4 ft.) in Length.



**Fig. 162**

**FIG. 162 - FOG HORN**  
**ALUMINUM WITH WHITE BAKED ENAMEL FINISH**  
**NYLON MOUTHPIECE**

**ORDERING INFORMATION**

Length Inches	Display Pkg. - 10 Bags 1 Pc. per Bag	Weight Ounces
12-1/2	162 DP WHT	6



**Fig. 349**

**FIG. 349 - "BALL TYPE" WHISTLE**

**ORANGE PLASTIC**

**ORDERING INFORMATION**

Length Inches	Width Inches	Display Pkg. - 10 Cards 1 Pc. per Card	OEM Bulk Pkg. 100 Pcs.	Weight Ounces
2-1/4	3/4	349 DP	349	1-1/2



**Fig. 441**

**FIG. 441 - PORTLIGHT CHAIN**

**STAINLESS STEEL CHAIN WITH CHROME PLATED FITTINGS**

**ORDERING INFORMATION**

Length Inches	Length Strap Inches	Display Pkg. - 5 Cards 1 Pc. per Card	OEM Bulk Pkg. 50 Pcs.	Screw Size	Weight Ounces
7	1-7/8	441 DP CHR	441 000 CHR	8	2

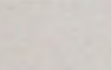

**Fig. 461**

**FIG. 461 - PORTLIGHT WEATHERSTRIPPING**

**OPEN CELL FOAM RUBBER**  
**SUPPLIED IN TEN FOOT LENGTHS**

**ORDERING INFORMATION**

Height Inches	Min. Width Inches	Max. Width Inches	Standard Pkg. - 1 Length
9/16	7/16	5/8	461

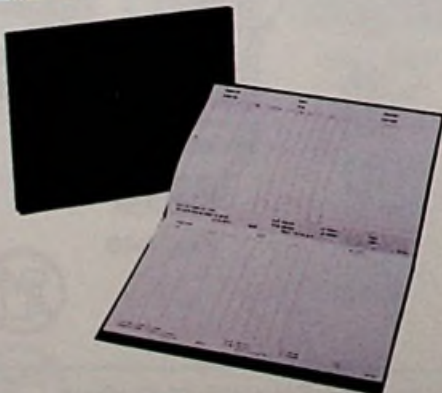

**Fig. 708**

**FIG. 708 - YACHT LOG BOOK**

**112 PAGES 8-1/4" x 11"**

Cover is hard plastic coated with a water resistant washable finish. Navy blue with gold lettering. In addition to pages for log data, these books contain useful information such as extracts from Bowditch Practical Navigator on symbols for weather, state of sea, cloud formations, force of wind, quest log and marine telephone log.

**ORDERING INFORMATION**

Display Pkg. - 5 Bags 1 Pc. per Bag	Weight Ounces
708 DP	18



## COWL & CLAM SHELL VENTILATORS

### FIG. 1312 - COWL VENTILATOR

**CHROME PLATED ZINC COWL WITH BLACK PLASTIC BASE**  
3 Inch Duct Threads into Neck, Hose Clamps Not Required

**chromalex®**

#### ORDERING INFORMATION

Mouth Opening Square Inches	Length Overall Inches	Width Overall Inches	Height Overall Inches	Display Pkg. - 5 Cards 1 Pc. per Card	OEM Bulk Pkg. 50 Pcs.	Screw Size	Weight Ounces
8	5-3/4	4-3/8	2-5/8	1312 DP CHR	1312 000 CHR	8	12



**Fig. 1312**

### FIG. 870 - COWL VENTILATOR

**CHROME PLATED ZINC**

3 Inch Duct Threads into Neck, Hose Clamps Not Required

#### ORDERING INFORMATION

Mouth Opening Square Inches	Length Overall Inches	Width Overall Inches	Height Overall Inches	Standard Pkg. 5 Pcs.	Screw Size	Weight Ounces
7-1/3	5-1/4	4	2-3/4	870 000 CHR	10	21



**Fig. 870**

### FIG. 510 - COWL VENTILATOR

**POLISHED OR CHROME PLATED BRASS. CAST BRONZE DECK PLATE**

Internal Thumb Screw Allows Cowl to be Locked in any Position.  
Ventilators are Painted White Inside Only.

#### ORDERING INFORMATION

I.D. Deck Plate Inches	O.D. Deck Plate Inches	Diameter Mouth Inches	Height Overall Inches	Polished Brass Standard Pkg. - 1 Pc.	Chrome Plated Brass Standard Pkg. - 1 Pc.	Screw Size	Weight Pounds
4	7-1/16	8	11	510 004 POL	510 004 CHR	10	6-3/8
5	8-3/8	10	13	510 005 POL	510 005 CHR	10	9-3/8

For Spare Deck Plates, Covers and Keys; Refer to Fig. No. 526, Page 96



**Fig. 510**

### FIG. 315 - CLAM SHELL VENTILATOR

**CHROME PLATED BRASS**

#### ORDERING INFORMATION

Dimensions Base Inches	Height Opening Inches	Width Opening Inches	Display Pkg. - 10 Cards 1 Pc. per Card	OEM Bulk Pkg. 100 Pcs.	Screw Size	Weight Ounces
1-5/8 x 1-1/2	7/16	7/8	315 DP1 CHR	315 001 CHR	4	1/2
2 x 2	9/16	1-7/8	315 DP2 CHR	315 002 CHR	6	1-1/4



**Fig. 315**

### FIG. 339 - CLAM SHELL VENTILATOR

**CHROME PLATED BRASS**

#### ORDERING INFORMATION

Dimensions Base Inches	Height Opening Inches	Width Opening Inches	Display Pkg. - 5 Cards 1 Pc. per Card	OEM Bulk Pkg. 25 Pcs.	Screw Size	Weight Ounces
4 x 3-3/4	1-5/8	2-1/2	339 DP CHR	339 000 CHR	6	5-1/2



**Fig. 339**

## GAS TANK VENTS



**FIG. 570 - GAS TANK VENT**

**CHROME PLATED ZINC COWL WITH BLACK OR WHITE PLASTIC CAP AND REMOVABLE 30 MESH, MONEL WIRE SCREEN FLAME ARRESTER**

**chromalex®**



**FIG. 570**

**ORDERING INFORMATION**

Color	Hose Size Inches	Max. Hull Thickness Inches	Display Pkg. - 10 Cards 1 Pc. per Card	OEM Bulk Pkg. 50 Pcs.	Weight Ounces
Black	5/8	3/4	570 DP4 BLK	570 004 BLK	3
White	5/8	3/4	570 DP4 WHT	570 004 WHT	3



**FIG. 571 - GAS TANK VENT WITH SWIVEL ELBOW**

**BLACK OR WHITE PLASTIC CAP WITH ZINC ELBOW AND REMOVABLE 30 MESH, MONEL WIRE SCREEN FLAME ARRESTER**  
Design Allows Elbow to be Rotated to any Position



**FIG. 571**

**ORDERING INFORMATION**

Color	Hose Size Inches	Max. Hull Thickness Inches	Display Pkg. - 10 Cards 1 Pc. per Card	OEM Bulk Pkg. 50 Pcs.	Weight Ounces
Black	5/8	3/4	571 DP4 BLK	571 004 BLK	3
White	5/8	3/4	571 DP4 WHT	571 004 WHT	3



**FIG. 561 - GAS TANK VENT WITH SWIVEL ELBOW**

**CHROME PLATED ZINC CAP WITH ZINC ELBOW, BLACK PLASTIC SPLASH GUARD AND REMOVABLE 30 MESH, MONEL WIRE SCREEN FLAME ARRESTER**  
Design Allows Elbow to be Rotated to any Position



**FIG. 561**

**chromalex®**

**ORDERING INFORMATION**

Hose Size Inches	Max. Hull Thickness Inches	Display Pkg. - 10 Cards 1 Pc. per Card	OEM Bulk Pkg. 50 Pcs.	Weight Ounces
5/8	1	561 DP4 CHR	561 004 CHR	3-1/4

Spare Splash Guard Cat. No. 518 000 BLK



**FIG. 506 - GAS TANK VENT**

**CHROME PLATED ZINC WITH BLACK PLASTIC SPLASH GUARD AND REMOVABLE 30 MESH, MONEL WIRE SCREEN FLAME ARRESTER**

**chromalex®**



**FIG. 506**

**ORDERING INFORMATION**

Hose Size Inches	Max. Hull Thickness Inches	Display Pkg. - 10 Cards 1 Pc. per Card	OEM Bulk Pkg. 100 Pcs.	Weight Ounces
5/8	3/4	506 DP4 CHR	506 004 CHR	3

Spare Splash Guard Cat. No. 518 000 BLK

**Note: All of the Above Vents are Designed to Meet the Requirements of U.S.C.G. Safety Standards January 31, 1977, for Gasoline Fuel Systems 33CFR183.**



## GAS TANK VENTS

**FIG. 509 - GAS TANK VENT**

**CHROME PLATED BRONZE**  
**WITH REMOVABLE 30 MESH, MONEL WIRE SCREEN FLAME ARRESTER**



**ORDERING INFORMATION**

Hose Size Inches	Max. Hull Thickness Inches	Display Pkg. - 5 Cards 1 Pc. per Card	OEM Bulk Pkg. 50 Pcs.	Weight Ounces
5/8	3/4	509 DP4 CHR	509 004 CHR	4
3/4	5/8	509 DP5 CHR	509 005 CHR	6



**Fig. 509**

**FIG. 503 - GAS TANK VENT**

**CHROME PLATED BRONZE**  
**WITH REMOVABLE 30 MESH, MONEL WIRE SCREEN FLAME ARRESTER**



**ORDERING INFORMATION**

Thread Size Inches	Max. Hull Thickness Inches	Display Pkg. - 5 Cards 1 Pc. per Card	OEM Bulk Pkg. 50 Pcs.	Weight Ounces
3/8	7/8	503 DP3 CHR	503 003 CHR	5-1/2
1/2	7/8	503 DP4 CHR	503 004 CHR	6



**Fig. 503**

**FIG. 515 - GAS TANK VENT**

**CHROME PLATED BRONZE**  
**WITH REMOVABLE 30 MESH, MONEL WIRE SCREEN FLAME ARRESTER**



**ORDERING INFORMATION**

Thread Size Inches	Max. Hull Thickness Inches	Display Pkg. - 5 Cards 1 Pc. per Card	OEM Bulk Pkg. 50 Pcs.	Weight Ounces
3/8	5/8	515 DP3 CHR	515 003 CHR	3
1/2	5/8	515 DP4 CHR	515 004 CHR	4



**Fig. 515**

**FIG. 505 - GAS TANK VENT**

**CHROME PLATED CAST BRONZE**  
**WITH REMOVABLE 30 MESH, MONEL WIRE SCREEN FLAME ARRESTER**



Designed to meet the requirements of the National Fire Protection Association Booklet No. 302, Section No. 323 on vent pipe outlets.  
 The 1/2 inch N.P.T. is off center to create a water baffle.

**ORDERING INFORMATION**

O.D. Flange Inches	O.D. Neck Inches	Length Neck Inches	Display Pkg. - 5 Cards 1 Pc. per Card	OEM Bulk Pkg. 25 Pcs.	Screw Size	Weight Ounces
2-1/2	1-3/16	1-1/2	505 DP CHR	505 000 CHR	8	6-1/2



**Fig. 505**

**Note: All of the Above Vents are Designed to Meet the Requirements of U.S.C.G. Safety Standards January 31, 1977, for Gasoline Fuel Systems 33CFR183.**

## VENTILATORS



**FIG. 707 - VENTILATOR**

**CHROME PLATED BRASS FRAME  
PERFORATED STAINLESS STEEL SCREEN**



**FIG. 707**

**ORDERING INFORMATION**

Dimensions Inches	Display Pkg. - 10 Cards 1 Pc. per Card	OEM Bulk Pkg. 25 Pcs.	Screw Size	Weight Ounces
7-1/4 x 1-1/2	707 DP CHR	707 000 CHR	8	2



**FIG. 330 - LOCKER VENTILATOR**

**CHROME PLATED BRASS**



**FIG. 330**

**ORDERING INFORMATION**

O.D. Inches	Display Pkg. - 10 Cards 1 Pc. per Card	OEM Bulk Pkg. 100 Pcs.	Screw Size	Weight Ounces
2-1/2	330 DP1 CHR	330 001 CHR	6 R.H.	3/4
3-1/4	330 DP2 CHR	330 002 CHR	6 R.H.	1



**FIG. 550 - TRANSOM OR LOCKER VENTILATOR**

**CHROME PLATED BRASS**

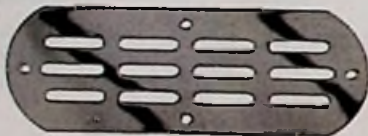

**FIG. 550**

**ORDERING INFORMATION**

Dimensions Inches	Display Pkg. - 10 Cards 1 Pc. per Card	OEM Bulk Pkg. 25 Pcs.	Screw Size	Weight Ounces
7 x 2-1/2	550 DP CHR	550 000 CHR	8	3



**FIG. 1271 - TRANSOM OR LOCKER VENTILATOR**

**CHROME PLATED ZINC  
WITH ANODIZED ALUMINUM GRILL-TYPE SCREEN**

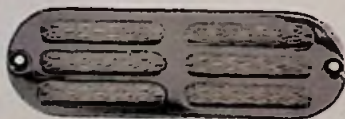

**FIG. 1271**

**ORDERING INFORMATION**

Dimensions Inches	Display Pkg. - 10 Cards 1 Pc. per Card	OEM Bulk Pkg. 25 Pcs.	Screw Size	Weight Ounces
6 x 2	1271 DP CHR	1271 000 CHR	8	3



**FIG. 1238 - TRANSOM OR LOCKER VENTILATOR**

**CHROME PLATED ZINC  
WITH ANODIZED ALUMINUM GRILL-TYPE SCREEN**



**FIG. 1238**

**ORDERING INFORMATION**

Dimensions Inches	Display Pkg. - 10 Cards 1 Pc. per Card	OEM Bulk Pkg. 50 Pcs.	Screw Size	Weight Ounces
8-3/8 x 2-1/4	1238 DP CHR	1238 000 CHR	8	4



## VENTILATORS

**FIG. 334 - LOUVER VENTILATOR**



**CHROME PLATED BRASS**

**ORDERING INFORMATION**

Dimensions Inches	Length Louvers Inches	Display Pkg. - 5 Cards 1 Pc. per Card	OEM Bulk Pkg. 10 Pcs.	Weight Ounces
3 x 2-1/2	2	334 002 DP	334 002 CHR	1-1/5
4 x 2-1/2	3	334 02A DP	334 02A CHR	1-4/5
5-1/2 x 2-1/2	2	334 004 DP	334 004 CHR	2-1/2
7-1/2 x 2-1/2	3	334 04A DP	334 04A CHR	3-1/5
8 x 2-1/2	2	334 006 DP	334 006 CHR	3-1/2
11 x 2-1/2	3	334 06A DP	334 06A CHR	4-1/2

Screw Size #4 R.H.

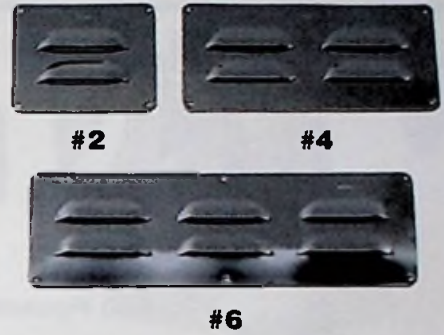

**FIG. 334**

**FIG. 335 - LOUVER VENTILATOR**



**CHROME PLATED BRASS**

**ORDERING INFORMATION**

Dimensions Inches	Length Louvers Inches	Display Pkg. - 5 Cards 1 Pc. per Card	OEM Bulk Pkg. 10 Pcs.	Weight Ounces
3 x 3	2	335 003 DP	335 003 CHR	1-1/2
4 x 3-1/2	3	335 03A DP	335 03A CHR	2
5-1/2 x 3	2	335 006 DP	335 006 CHR	3
7-1/2 x 3-1/2	3	335 06A DP	335 06A CHR	4-1/2
8 x 3	2	335 009 DP	335 009 CHR	4
11 x 3-1/2	3	335 09A DP	335 09A CHR	6-1/2

Screw Size #4 R.H.

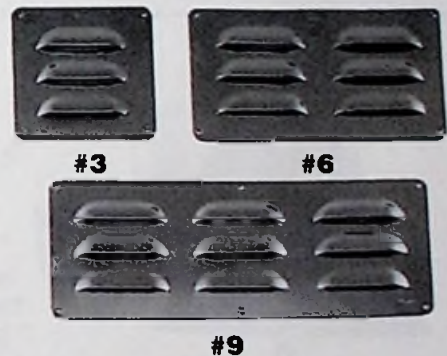

**FIG. 335**

**FIG. 336 - LOUVER VENTILATOR**



**CHROME PLATED BRASS**

**ORDERING INFORMATION**

Dimensions Inches	Length Louvers Inches	Display Pkg. - 5 Cards 1 Pc. per Card	OEM Bulk Pkg. 10 Pcs.	Weight Ounces
3-3/4 x 3	2	336 004 DP	336 004 CHR	2
4-3/8 x 4	3	336 04A DP	336 04A CHR	3
4-1/2 x 3	2	336 005 DP	336 005 CHR	2-1/2
5-3/8 x 4	3	336 05A DP	336 05A CHR	3-4/5
5-1/4 x 3	2	336 006 DP	336 006 CHR	2-4/5
6-3/8 x 4	3	336 06A DP	336 06A CHR	4-1/3

Screw Size #4 R.H.



**FIG. 336**

## FOG BELLS

**THE 8, 10 AND 12 INCH BELLS LISTED ON THIS PAGE HAVE BEEN REVIEWED BY THE U.S. COAST GUARD AND COMPLY WITH C.G. 169 REGULATIONS FOR SOUND SIGNAL APPLIANCES AS REQUIRED BY ANNEX III PARAGRAPH 2 OF THE '72 COLREGS. THE 8 AND 10 INCH SIZES ARE FOR USE ON VESSELS UNDER 20 METERS (65.6 FT.) IN LENGTH. THE 12 INCH SIZE IS FOR USE ON VESSELS OF ANY LENGTH.**



**FIG. 420 POLISHED**



**FIG. 420 CHROME**

**FIG. 420 - FOG BELL**

**CAST BRONZE**

Polished or Chrome Plated Bronze  
Medium Weight, Removable

**ORDERING INFORMATION**

Bottom Diameter Inches	Height Overall Inches	Polished Bronze Std. Pkg. - 1 Pc.	Chrome Plated Bronze Std. Pkg. - 1 Pc.	Weight Pounds
6	5	420 006 POL	420 006 CHR	4-1/4
8	6-1/8	420 008 POL	420 008 CHR	7-1/8

Screw Size #8 F.H.

**FIG. 150 - FOG BELL**

**CAST BRONZE**

Plain, Polished or Chrome Plated Bronze  
Heavy Weight, Removable

**ORDERING INFORMATION**

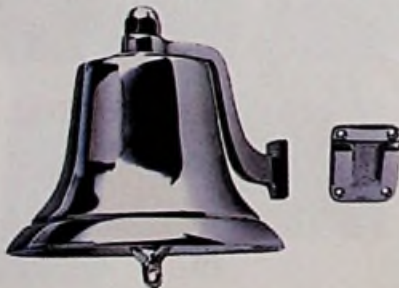

**Fig. 150**

Bottom Diameter Inches	Height Overall Inches	Plain Bronze Std. Pkg. - 1 Pc.	Polished Bronze Std. Pkg. - 1 Pc.	Chrome Plated Bronze Std. Pkg. - 1 Pc.	Weight Pounds
8	8	150 008 PLB	150 008 POL	150 008 CHR	11
10	10-1/2	150 010 PLB	150 010 POL	150 010 CHR	20-1/2
12	12	150 012 PLB	150 012 POL	150 012 CHR	28-1/4

Screw Size 1/4" F.H.

**SPARE PARTS ORDERING INFORMATION FOR PAGES 86 AND 87.**

For complete Spare Part No. insert Finish Code:

P or PLB, for Plain Bronze or Brass Finish (i.e. 420 P06 99A or 127 000 PLB)  
B or POL, for Polished Bronze or Brass Finish (i.e. 420 B06 99A or 127 000 POL)  
C or CHR, for Chrome Plated Finish (i.e. 420 C06 99A or 127 000 CHR)

ARMS		WALL PLATES		CLAPPERS		EYE BOLTS		ACORN NUTS	
Figure No.	Spare Part No.	Figure No.	Spare Part No.	Figure No.	Spare Part No.	Figure No.	Spare Part No.	Figure No.	Spare Part No.
420-6"	420-99A-6"	420-6"	127	420-6"	153	420-8"	113	420-6"	465 004
420-8"	171	420-8"	127	420-8"	144	420-8"	123	420-8"	465 008
150-8"	171	150-8"	127	150-8"	144	150-8"	123	150-8"	465 008
150-10"	150-99A-10"	150-10"	150-99B-10"	150-10"	150-99C	150-10"	150-99D	150-10"	465 009
150-12"	150-99A-12"	150-12"	150-99B-12"	150-12"	172	150-12"	172	150-12"	465 009
*158-12"	158-99A-12"	*158-12"	158-99A-12"	*158-12"	172	*158-12"	172	158-12"	465 009
*159-8-14"	158-99A-14"	*159-8-14"	158-99A-14"	*159-8-14"	172	*159-8-14"	172	159-8-14"	465 009
179	179-000-99A	179	179-000-99A	179	144	179	179-99B	179	465 008
159-6"	159-99A	159-6"	166	159-6"	159-99B	159-6"	113	159-6"	465 004
159-8"	159-99A	159-8"	166	159-8"	153	159-8"	113	159-8"	465 004
*Includes Wall Bracket		*Includes Arm		*Includes Eye Bolt		*Includes Clapper			



## FOG BELLS

**THE 8 AND 12 INCH BELLS LISTED ON THIS PAGE HAVE BEEN REVIEWED BY THE U.S. COAST GUARD AND COMPLY WITH C.G. 169 REGULATIONS FOR SOUND SIGNAL APPLIANCES AS REQUIRED BY ANNEX III PARAGRAPH 2 OF THE '72 COLREGS. THE 8 AND 10 INCH SIZES ARE FOR USE ON VESSELS UNDER 20 METERS (65.6 FT.) IN LENGTH. THE 12 INCH SIZE IS FOR USE ON VESSELS OF ANY LENGTH.**

**FIG. 158 - FOG BELL**

**CAST BRONZE**

Plain, Polished or Chrome Plated Bronze  
Heavy Weight, Fixed Mounting

**ORDERING INFORMATION**

Bottom Diameter Inches	Height Overall Inches	Plain Bronze Std. - 1 pc.	Polished Bronze Std. Pkg. - 1 Pc.	Chrome Plated Bronze Std. Pkg. - 1 Pc.	Weight Pounds
12	12	158 012 PLB	158 012 POL	158 012 CHR	29-2/3

Screw Size 1/4" R.H.



**FIG. 158 POLISHED**

**FIG. 179 - FOG BELL**

**WROUGHT BRASS**

Plain Brass  
Light Weight, Fixed Mounting

**ORDERING INFORMATION**

Bottom Diameter Inches	Height Overall Inches	Standard Pkg. - 1 Pc.	Weight Pounds
12	8	179 012 PLB	7-3/4

Screw Size #12 R.H.



**FIG. 179**

**FIG. 159 - FOG BELL**

**STAMPED BRASS**

Plain or Chrome Plated Brass  
Light Weight, Removable

**ORDERING INFORMATION**

Bottom Diameter Inches	Height Overall Inches	Chrome Plated Display Pkg. - 2 Pcs. 1 Pc. per Pkg.	Plain Brass Display Pkg. - 2 Pcs. 1 Pc. per Pkg.	Weight Pounds
6	4	159 DP6 CHR	159 DP6 PLB	1-1/2
8	5	159 DP8 CHR	159 DP8 PLB	2-3/4

Screw Size #4 F.H.



**FIG. 159 CHROME**



**FIG. 159 PLAIN**

## INTAKE WATER STRAINERS

### FIGS. 493 & 500 - INTAKE WATER STRAINERS CAST BRONZE

PERKO WATER STRAINERS ARE DESIGNED FOR EASY INSTALLATION AND CLEANING. FEATURES INCLUDE MOUNTING LUGS CAST INTO BOTH SIDES TO ASSURE UNIVERSAL MOUNTING, FOUR OUTSIDE TIE RODS AND A 304 STAINLESS STEEL STRAINER BASKET TO MINIMIZE ELECTROLYSIS. HINGED LUGS FOR THE CAST BRONZE COVER PERMIT EASY REMOVAL AND CLEANING OF THE STRAINER BASKET. A DRAIN PLUG IN THE BOTTOM CASTING IS PROVIDED FOR EASILY REMOVING SEDIMENT AND DRAINING FOR WINTERIZING.

FOR APPLICATIONS REQUIRING HIGHER CAPACITY SEE FIG. 500 BELOW

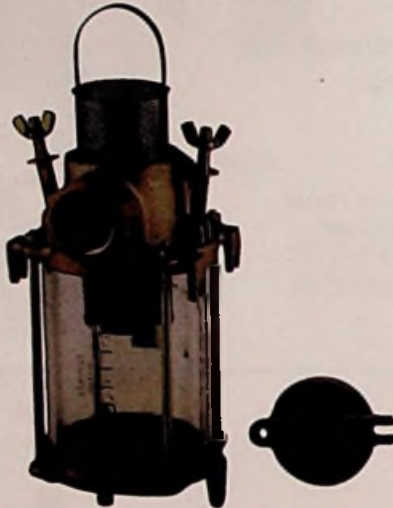

FIG. 493

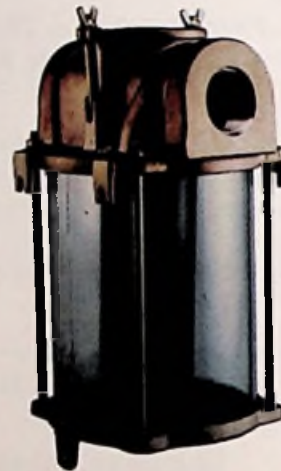

FIG. 500

#### ORDERING INFORMATION FOR FIG. 493

Pipe Size Inches	Height Overall Inches	Width Overall Inches	Standard Pkg. - 1 Pc.	Dimensions Cylinder Inches	Dimensions Basket Inches	Open Area To Pipe Size Ratio	Weight Pounds	Spare Gasket Kit* Display Pkg. - 5 kts 1 Kit. per Bag
3/8	4-1/4	3-1/4	493 003 PLB	2-3/4 x 2-1/2	1-3/16 x 2-3/4	22:1	2-1/2	493 DP3 99M
1/2	5-3/4	4-1/2	493 004 PLB	3-1/2 x 4	1-13/16 x 4-3/8	30:1	5	493 DP4 99M
3/4	8-3/8	4-1/2	493 005 PLB	3-1/2 x 6	1-13/16 x 6-1/4	25:1	5	493 DP5 99M
1	9-1/2	5-1/2	493 006 PLB	4-1/2 x 5-1/2	2-5/8 x 5-7/8	20:1	8	493 DP6 99M
1-1/4	10	5-1/2	493 007 PLB	4-1/2 x 6	2-5/8 x 6-1/4	13:1	8	493 DP7 99M
1-1/2	11-1/2	7-1/4	493 008 PLB	6 x 8	3-5/16 x 8-7/16	17:1	14	493 DP8 99M
2	16	7-1/2	493 009 PLB	6 x 12	3-5/16 x 12-1/4	13:1	18	493 DP9 99M
2-1/2	16	7-1/2	493 010 PLB	6 x 12	3-5/16 x 12-1/2	10:1	18	493 DPX 99M

#### ORDERING INFORMATION FOR FIG. 500

Pipe Size Inches	Height Overall Inches	Width Overall Inches	Standard Pkg. - 1 Pc.	Dimensions Cylinder Inches	Dimensions Basket Inches	Open Area To Pipe Size Ratio	Weight Pounds	Spare Gasket Kit* Standard Pkg. - 1 kit
2	14-1/2	9	500 009 PLB	8 x 10	3-7/8 x 10-1/4	20:1	34	500 009 99M
2-1/2	16-1/2	9	500 010 PLB	8 x 12	3-7/8 x 12-1/4	18:1	34	500 010 99M
3	18-1/2	9	500 011 PLB	8 x 14	3-7/8 x 14-1/4	14:1	34	500 011 99M

\*Spare Gasket Kit Consists of: 1 - Cover Gasket and 2 - Cylinder Gaskets.

#### SPARE PARTS ORDERING INFORMATION

For Spare Part No. Insert a Spare Part Code Listed Below In Place of the "PLB" in the Strainer's Catalog Number (i.e., 493 006 99A, Top Casting for 1" Strainer).

Top Casting	99A	Cover with Gasket	99E	Cover Gaskets (2 Per Bag)	99N
Bottom Casting	99B	Hinged Bolt for Cover		Tie Rods, Nuts and Washers	99P
Transparent Cylinder	99C	With Pin, Nut and Washer	99L	Consists of:	
Basket Strainer	99D			(4 Each for 493 Series)	
				(1 Each for 500 Series)	



## INTAKE WATER STRAINERS

**FIG. 493 & 500 - INTAKE WATER STRAINERS  
DIFFERENTIAL PRESSURE GRAPHS**

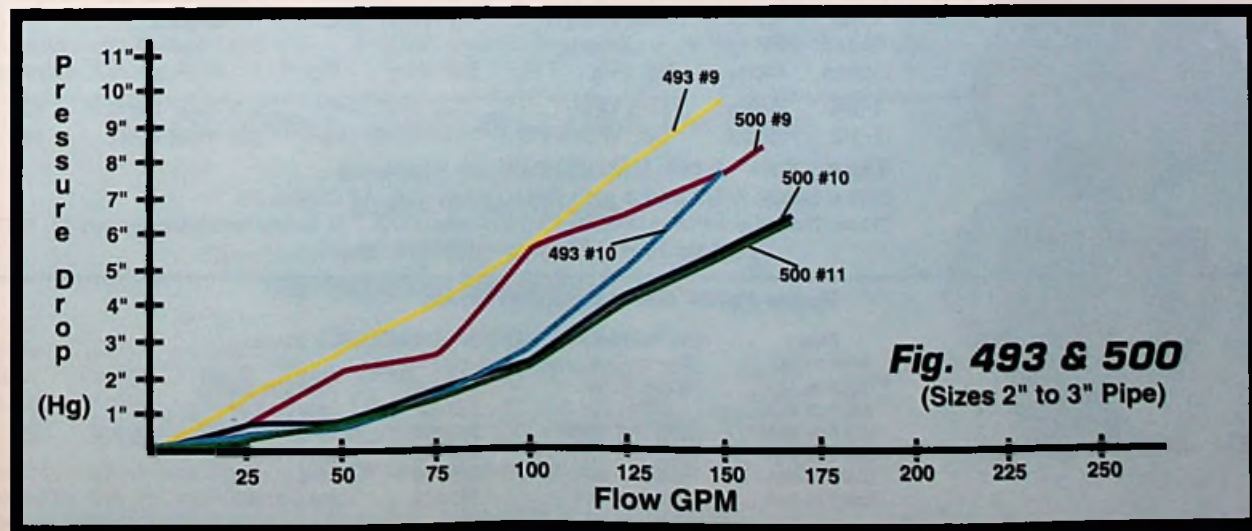
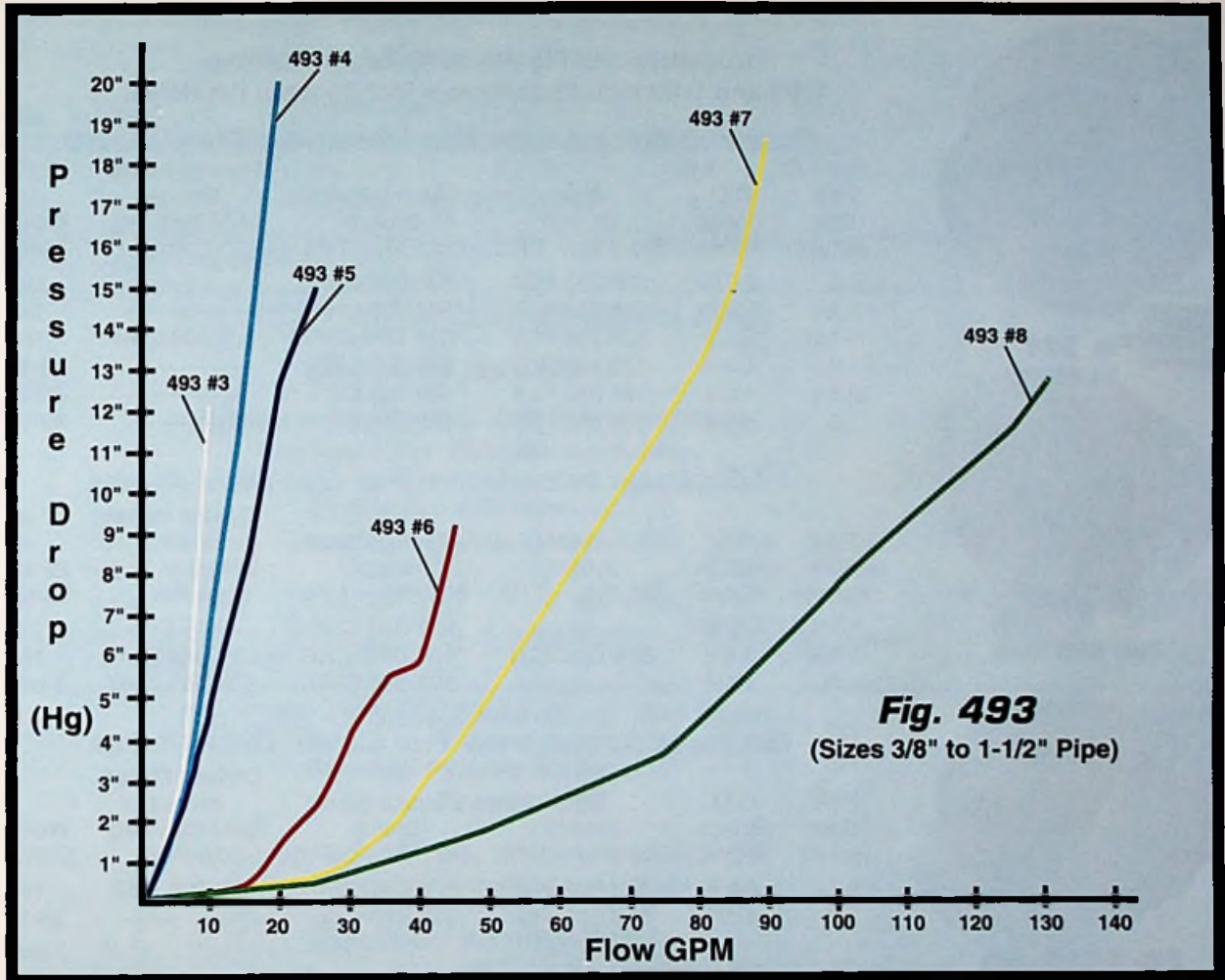

## DECK PLATES



### FIG. 528 - DECK PLATES FOR PIPE

#### CAST BRONZE PLAIN OR CHROME PLATED

Complete with Fig. No. 1248 Key and O-Ring.  
1-1/4 and 1-1/2 Inch Caps Have a Slot Between the Holes.



FIG. 528



FIG. 528 GAS



FIG. 528 DIESEL



FIG. 528 WATER

#### ORDERING INFORMATION FOR UNMARKED DECK PLATES

Pipe Size Inches	O.D. Flange Inches	Plain Bronze Std. Pkg. - 1 Pc.	Chrome Plated Bronze Std. Pkg. - 1 Pc.	Chrome Plated Bronze OEM Bulk Pkg. 10 Pcs.	Weight Ounces
1	2-7/8	528 006 PLB	528 006 CHR	-----	12
1-1/4	3-5/16	528 007 PLB	528 007 CHR	-----	12
1-1/2	3-5/8	528 008 PLB	*528 DP8 CHR	528 008 CHR	16
2	4-1/4	528 009 PLB	528 009 CHR	-----	33-1/2
2-1/2	4-5/8	528 010 PLB	528 010 CHR	-----	33-1/2
3	5-3/8	528 011 PLB	528 011 CHR	-----	43-1/2

#### \* \* ORDERING INFORMATION FOR GAS DECK PLATES

Pipe Size Inches	O.D. Flange Inches	Plain Bronze Std. Pkg. - 1 Pc.	Chrome Plated Bronze Std. Pkg. - 1 Pc.	Chrome Plated Bronze OEM Bulk Pkg. 10 Pcs.	Weight Ounces
1-1/4	3-5/16	-----	528 G07 CHR	-----	12
1-1/2	3-5/8	528 G08 PLB	*528 DPG CHR	528 G08 CHR	16
2	4-1/4	-----	528 G09 CHR	528 G09 CHR	33-1/2

#### ORDERING INFORMATION FOR DIESEL DECK PLATES

Pipe Size Inches	O.D. Flange Inches	Plain Bronze Std. Pkg. - 1 Pc.	Chrome Plated Bronze Std. Pkg. - 1 Pc.	Chrome Plated Bronze OEM Bulk Pkg. 10 Pcs.	Weight Ounces
1-1/2	3-5/8	528 D08 PLB	*528 DPD CHR	528 D08 CHR	16
2	4-1/4	528 D09 PLB	528 D09 CHR	-----	33-1/2

#### ORDERING INFORMATION FOR WATER DECK PLATES

Pipe Size Inches	O.D. Flange Inches	Plain Bronze Std. Pkg. - 1 Pc.	Chrome Plated Bronze Std. Pkg. - 1 Pc.	Chrome Plated Bronze OEM Bulk Pkg. 10 Pcs.	Weight Ounces
1-1/4	3-5/16	528 W07 PLB	528 W07 CHR	528 W07 CHR	12
1-1/2	3-5/8	528 W08 PLB	*528 DPW CHR	528 W08 CHR	16

\*Display Pack - 5 pcs. (1Pc. per card)

Screw Sizes: 2-1/2 and 3 Inch Deck Plates #10, All Others #8.

\*\*Note: These Deck Plates Meet the Requirements of U.S.C.G. Safety Standards, January 31, 1977, for Gasoline Fuel Systems, 33CFR183.

#### Spare Parts Ordering Information

Pipe Size Inches	Plain Bronze Cap*	Chrome Plated Bronze Cap*	O-Rings Only (2 per bag)	Spare Key
1	528 P06 99A	528 C06 99A	513 006	1248 006 ZNC
1-1/4	528 P07 99A	528 C07 99A	513 007	1248 7-8 DP***
1-1/2	528 P08 99A	528 DP8 99A**	513 008	1248 7-8 DP***
2	528 P09 99A	528 C09 99A	513 009	1248 009 ZNC
2-1/2	528 P10 99A	528 C10 99A	513 010	1248 010ZNC
3	528 P11 99A	528 C11 99A	513 011	528 011 99C

\* Complete With O-Ring.

\*\* Display Pkg. - 5 pcs. (1 pc. per card).

\*\*\* Display Pkg. - 10 pcs. (1 pc. per card).



## DECK PLATES

### FIG. 524 - WASTE DECK PLATE FOR PIPE

#### CHROME PLATED BRONZE

Complete with Fig. No. 1248 Key and O-Ring  
Cap Has a Slot Between the Holes.



FIG. 524

#### ORDERING INFORMATION

Pipe Size Inches	O.D. Flange Inches	Display Pkg. - 5 Cards 1 Pc. per Card	OEM Bulk Pkg. 10 Pcs.	Screw Size	Weight Ounces
1-1/2	3-5/8	524 DP CHR	524 000 CHR	8	16

Spare Cap with O-Ring, Cat. No. 524 DP 99A.  
Spare Key, Cat. No. 1248 7-8 DP.

Spare O-Rings Only (2 per bag), Cat. No. 513 008.

### FIG. 507 - WASTE DECK PLATE FOR HOSE

#### CHROME PLATED BRONZE

Complete with Fig. No. 1248 Key and O-Ring  
Cap Has a Slot Between the Holes.



FIG. 507

#### ORDERING INFORMATION

Hose Size Inches	O.D. Flange Inches	Length Neck Inches	Display Pkg. - 5 Cards 1 Pc. per Card	OEM Bulk Pkg. 50 Pcs.	Screw Size	Weight Ounces
1-1/2	3-1/8	3-1/2	507 DP CHR	507 000 CHR	8	14

Spare Cap with O-Ring, Cat. No. 507 DP 99A.  
Spare Key, Cat. No. 1248 7-8 DP.

Spare O-Rings Only (2 per bag), Cat. No. 513 008.

### FIG. 508 - WASTE DECK PLATE FOR HOSE

#### CHROME PLATED BRONZE BLACK PLASTIC CAP

Complete with Fig. No. 1248 Key and O-Ring  
Cap Has a Slot Between the Holes.

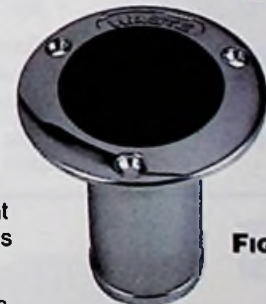

FIG. 508

#### ORDERING INFORMATION

Hose Size Inches	O.D. Flange Inches	Length Neck Inches	Display Pkg. - 5 Cards 1 Pc. per Card	OEM Bulk Pkg. 50 Pcs.	Screw Size	Weight Ounces
1-1/2	3-1/8	3-1/2	508 DP CHR	508 000 CHR	8	11

Spare Cap with O-Ring, Cat. No. 508 DP 99A.  
Spare Key, Cat. No. 1248 7-8 DP.

Spare O-Rings Only (2 per bag), Cat. No. 513 008.

### FIG. 1269 - WASTE DECK PLATE FOR HOSE

#### CHROME PLATED ZINC BLACK PLASTIC CAP

Complete with Fig. No. 1248 Key and O-Ring  
Cap Has a Slot Between the Holes.



FIG. 1269

#### ORDERING INFORMATION

Hose Size Inches	O.D. Flange Inches	Length Neck Inches	Display Pkg. - 5 Cards 1 Pc. per Card	OEM Bulk Pkg. 50 Pcs.	Screw Size	Weight Ounces
1-1/2	3-1/2	2-1/2	1269 DP CHR	1269 000 CHR	8	8

Spare Cap with O-Ring, Cat. No. 1269 DP 99A.  
Spare Key, Cat. No. 1248 7-8 DP.

Spare O-Rings Only (2 per bag), Cat. No. 513 008.

NOTE: These Items Comply with Adopted Standards on "Fittings" A.B.Y.C. Recommended Practices Standards Covering Sewage Holding and/or Treatment Devices for Marine Waste Systems.

## DECK PLATES

### FIG. 527 - DECK PLATES FOR HOSE

#### CHROME PLATED BRONZE 35° ANGLED HOSE BIBS

Complete with Fig. No. 1247 Key,  
O-Ring and Fig. No. 537 Retaining Cable on Cap.  
Caps Have A Slot Between the Holes.



**Fig. 527**

#### ORDERING INFORMATION

Marked For:	Hose Size Inches	O.D. Flange Inches	Length Neck Inches	Standard Pkg. - 1 Pc.	Screw Size	Weight Pounds
*Gas	1-1/2	3-1/2	4-7/8	527 G08 CHR	10	2-3/8
Diesel	1-1/2	3-1/2	4-7/8	527 D08 CHR	10	2-3/8

Spare Cap with O-Ring, Cat. No. 528 DP8 99A.  
Spare Key, Cat. No. 1247 DP CHR.

Spare O-Rings Only (2 per bag), Cat. No. 513 008.



### FIG. 520 - DECK PLATES FOR HOSE

#### CHROME PLATED BRONZE

Complete with Fig. No. 1248 Key,  
O-Ring and Integral Retainer on Cap.  
Caps Have A Slot Between the Holes.



**Fig. 520**

#### ORDERING INFORMATION

Marked For:	Hose Size Inches	O.D. Flange Inches	Length Neck Inches	Display Pkg. - 5 Cards 1 Pc. per Card	OEM Bulk Pkg. 50 Pcs.	Screw Size	Weight Ounces
*Gas	1-1/2	3-1/8	3-1/2	520 DPG CHR	520 G00 CHR	8	14
Diesel	1-1/2	3-1/8	3-1/2	520 DPD CHR	520 D00 CHR	8	14
Water	1-1/2	3-1/8	3-1/2	520 DPW CHR	520 W00 CHR	8	14

Spare Cap with O-Ring and Retainer, Cat. No. 520 DP 99A.  
Spare O-Rings Only (2 per bag), Cat. No. 513 008.

Spare Key, Cat. No. 1248 7-8 DP.



### FIG. 521 - DECK PLATES FOR HOSE

#### CHROME PLATED BRONZE BLACK PLASTIC CAP

Complete with Fig. No. 1248 Key,  
O-Ring and Integral Retainer on Cap.  
Caps Have A Slot Between the Holes.



**Fig. 521**

#### ORDERING INFORMATION

Marked For:	Hose Size Inches	O.D. Flange Inches	Length Neck Inches	Display Pkg. - 5 Cards 1 Pc. per Card	OEM Bulk Pkg. 50 Pcs.	Screw Size	Weight Ounces
*Gas	1-1/2	3-1/8	3-1/2	521 DPG CHR	521 G00 CHR	8	11
Diesel	1-1/2	3-1/8	3-1/2	521 DPD CHR	521 D00 CHR	8	11
Water	1-1/2	3-1/8	3-1/2	521 DPW CHR	521 W00 CHR	8	11

Spare Gas Cap with O-Ring and Retainer, Cat. No. 521 DPG 99A.  
Spare Diesel Cap with O-Ring and Retainer, Cat. No. 521 DPD 99A.  
Spare Water Cap with O-Ring and Retainer, Cat. No. 521 DPW 99A.

Spare O-Rings Only (2 per bag), Cat. No. 513 008.  
Spare Key, Cat. No. 1248 7-8 DP.

\*NOTE: These Items Meet the Requirements of U.S.C.G. Safety Standards, January 31, 1977, for Gasoline Fuel Systems, 33CFR183.



## DECK PLATE, GAS FILL & CAPS

**FIG. 1270 - DECK PLATE FOR HOSE**

**CHROME PLATED ZINC  
BLACK PLASTIC CAP**

Complete with Fig. No. 1248 Key,  
O-Ring and Integral Retainer on Cap.  
Caps Have A Slot Between the Holes.



**FIG. 1270**

**ORDERING INFORMATION**

Marked For:	Hose Size Inches	O.D. Flange Inches	Length Neck Inches	Display Pkg. - 5 Cards 1 Pc. per Card	OEM Bulk Pkg. 50 Pcs.	Screw Size	Weight Ounces
*Gas	1-1/2	3-1/2	2-1/2	1270 DPG CHR	1270 G00 CHR	8	8
Diesel	1-1/2	3-1/2	2-1/2	1270 DPD CHR	1270 D00 CHR	8	8
Water	1-1/2	3-1/2	2-1/2	1270 DPW CHR	1270 W00 CHR	8	8

Spare Gas Cap with O-Ring and Retainer, Cat. No. 1270 DPG 99A. Spare O-Rings Only (2 per bag), Cat. No. 513 008.  
Spare Diesel Cap with O-Ring and Retainer, Cat. No. 1270 DPD 99A. Spare Key, Cat. No. 1248 7-8 DP.  
Spare Water Cap with O-Ring and Retainer, Cat. No. 1270 DPW 99A.

**FIG. 1413 - GAS FILL**

**CHROME PLATED ZINC  
BLACK PLASTIC CAP AND BASE**

Complete with Integral Cap Retainer/Gasket

**chromalex**

**ORDERING INFORMATION**

For Hose Inches	Length Neck Inches	Dimensions Overall Inches	Std. Pkg. - 1 Pc. OEM Bulk Pkg. - 50 Pcs.	Screw Size	Weight Ounces
1-1/2	1-7/8	3 x 3	*1413 000 CHR	6	7

Spare Cap, Cat. No. 126 DP BLK.



**FIG. 1413**

\*NOTE: These Items Meet the Requirements of U.S.C.G. Safety Standards, January 31, 1977, for Gasoline Fuel Systems, 33CFR183.

**FIG. 126 & 1324 - CAPS**

**BLACK PLASTIC  
COMPLETE WITH GASKET**

**FIG. 1324 HAS A BUILT-IN LOCK WITH COVER**

Fig. 1324 is Supplied with 2 Keys  
Both Caps Will Fit all PERKO CHROMALEX® Fills



**FIG. 126**

**chromalex**

**ORDERING INFORMATION**

Cap Type	Display Pkg. - 5 Cards** 1 Pc. per Card	Weight Ounces
Non-Locking	126 DP BLK	1/2
Locking	1324 DP BLK	3

\*\*All Keyed Alike



**FIG. 1324**

## FILLS



**Fig. 1313**



**Fig. 1399**

### FIGS. 1313 & 1399 - GAS FILLS

PATENT No. 3,828,714

#### CHROME PLATED ZINC BLACK PLASTIC FLANGE AND CAP

Complete with Grounding Screw, Cap Retainer and Gasket.  
Locking Cap Has a Cover for the Key Hole.

**chromolex®**

#### ORDERING INFORMATION

Marked For:	Hose Size Inches	O.D. Flange Inches	Length Neck Inches	Display Pkg. - 5 Cards 1 Pc. per Card	OEM Bulk Pkg. 50 Pcs.	Weight Ounces
*Gas	1-1/2	3-1/8	1-7/8	1313 DP CHR	1313 000 CHR	8
*Gas w/Lock	1-1/2	3-1/8	1-7/8	1399 DP CHR	1399 000 CHR	8

Screw Size #6.

Spare Non-Locking Cap, Cat. No. 126 DP BLK.

Spare Locking Cap, Cat. No. 1324 DP BLK.



**Fig. 1613**

### FIGS. 1613 - PLASTIC GAS FILL

**BLACK PLASTIC  
FIBER REINFORCED, U.V. STABILIZED  
EASY-GRIP CAP**  
COMPLETE WITH O-RING AND CAP RETAINER.  
No Deck Plate Key or Ground Wire Required.

#### ORDERING INFORMATION

For Hose Inches	O.D. Overall Inches	Length Neck Inches	Display Pkg. - 5 Cards 1 Pc. per Card	OEM Bulk Pkg. 50 Pcs.	Screw Size	Weight Ounces
1-1/2	3-1/16	2-7/16	1613 DP BLK*	*1613 000 BLK	8	4

Spare Cap with O-Ring and Retainer, Cat. No. 1613 000 99A.

Spare O-Rings (2 per bag), Cat. No. 513 008.



**Fig. 1319**



### FIGS. 1319 - COMBINATION GAS FILL & TANK VENT

PATENT PENDING

**BLACK OR WHITE PLASTIC  
INTEGRAL TANK VENT WITH FLAME ARRESTOR.  
FLIP TOP CAP**

No Deck Plate Key or Ground Wire Required.

#### ORDERING INFORMATION

Marked For:	For Fuel Hose Inches	For Vent Hose Inches	Length Neck Inches	Display Pkg. - 10 Cards 1 Pc. per Card	OEM Bulk Pkg. 50 Pcs.	Screw Size	Weight Ounces
Gas	1-1/2	5/8	2-7/16	1319 DPG BLK*	1319 G00 BLK	10	4-1/2
Gas	1-1/2	5/8	2-7/16	1319 DPG WHT*	1319 G00 WHT	10	4-1/2
Diesel	1-1/2	5/8	2-7/16	1319 DPD BLK	1319 D00 BLK	10	4-1/2
Diesel	1-1/2	5/8	2-7/16	-----	1319 D00 WHT	10	4-1/2
Water	1-1/2	5/8	2-7/16	1319 DPW BLK	1319 W00 BLK	10	4-1/2
Water	1-1/2	5/8	2-7/16	-----	1319 W00 WHT	10	4-1/2

\*NOTE: These Items Meet the Requirements of U.S.C.G. Safety Standards, January 31, 1977, for Gasoline Fuel Systems, 33CFR183.



## DECK PLATE KEYS & CABLE

**FIG. 1247 - DECK PLATE KEY**

**CHROME PLATED ZINC**

Compact Size with Hole for Key Chain.  
Will Fit PERKO 1-1/4" and 1-1/2" Deck Plates  
and Many Other "Slot" Type Opening Deck Plates.

**ORDERING INFORMATION**

C. to C. of Lugs	Length Spade Inches	Length Overall Inches	Display Pkg. - 10 Bags 1 Pc. per Bag	Weight Ounces
1-1/8	1	1-3/4	1247 DP CHR	1



**FIG. 1247**



**FIG. 1248 - DECK PLATE KEY**

**PLAIN ZINC**

The Keys For 1" Thru 1-1/2" Deck Plates Have a 1 Inch Spade on Handle  
That Allows Them to Fit Many Other "Slot" Type Opening Deck Plates.

**ORDERING INFORMATION**

For Deck Plate Size Inches	C. to C. of Lugs	Length Overall Inches	Display Pkg. - 10 Bags 1 Pc. per Bag	Standard Pkg. - 10 Pc.	Weight Ounces
1	5/8	3-3/8	-----	1248 006 ZNC	2
1-1/4 & 1-1/2	1-1/8	3-3/8	1248 7-8 DP	-----	2
2	1-11/16	4-3/8	-----	1248 009 ZNC	2-1/2
2-1/2	2	4-3/8	-----	*1248 010 ZNC	2-1/2



**FIG. 1248**



\*Standard Pkg. - 1 pc.

**FIG. 1248 - DECK PLATE KEY**

**CHROME PLATED ZINC**

Hardened Steel Pins  
Will Fit Sizes up to 8 Inch Diameter

**ORDERING INFORMATION**

Length Overall Inches	Display Pkg. - 5 Cards 1 Pc. per Card	Weight Ounces
8-1/2	826 DP CHR	9-1/2



**FIG. 826**

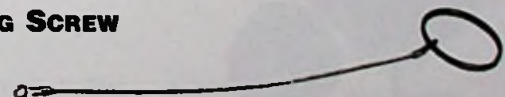

**FIG. 537 - RETAINING CABLE FOR DECK PLATES**

**STAINLESS STEEL CABLE AND FITTINGS WITH  
1-3/8" STAINLESS STEEL RING AND SELF TAPPING SCREW**

**ORDERING INFORMATION**

Length Cable Inches	Display Pkg. - 5 Cards 1 Pc. per Card	Weight Ounces
7	537 DP CHR	1/2



**FIG. 537**



## DECK PLATE & FITTINGS

**FIG. 526 - REGULAR DECK PLATE**

**CAST BRONZE  
PLAIN OR CHROME PLATED**

Complete with Key

**ORDERING INFORMATION**



**FIG. 526**

I.D. Opening Inches	O.D. Overall Inches	Plain Bronze Standard Pkg. - 1 Pc.	Chrome Plated Bronze Standard Pkg. - 1 Pc.	Screw Size	Weight Pounds
3	5-3/8	526 003 PLB	526 003 CHR	10	2
4	7-1/16	526 004 PLB	526 004 CHR	10	3-3/8
5	8-3/8	526 005 PLB	526 005 CHR	10	4-3/4
6	9-3/8	526 006 PLB	526 006 CHR	1/4	7-1/2
8	10-1/4	526 008 PLB	-----	1/4	8-3/4

**Spare Parts Ordering Information**

I.D. Opening Inches	Plain Bronze Cap	Chrome Plated Bronze Cap	Spare Key Only
3	526 P03 99A	526 C03 99A	539 003 ZNC
4	526 P04 99A	526 C04 99A	539 004 PLB
5	526 P05 99A	526 C05 99A	539 005 PLB
6	526 P06 99A	526 C06 99A	539 006 PLB
8	526 P08 99A	-----	539 008 PLB



**FIG. 499 - WATER INLET FITTING**

**CHROME PLATED BRONZE**

Standard Female Swivel Hose Connector.  
Complete With Black Plastic Watertight Plug and Stainless Steel Bead Chain.  
For Obtaining Water Under Pressure At Dockside.



**FIG. 499**

**ORDERING INFORMATION**

Pipe Size Inches	O.D. Flange Inches	Display Pkg. - 5 Cards 1 Pc. per Card	OEM Bulk Pkg. 10 Pcs.	Screw Size	Weight Ounces
1/2	2-3/4	499 DP CHR	499 000 CHR	8	8

Spare Plug with Chain, Cat. No. 499 DP 99A.



**FIG. 504 - WATER OUTLET FITTING**

**CHROME PLATED BRONZE**

Standard Male Hose Connector.  
Complete With Watertight Black Plastic Cap and Stainless Steel Bead Chain.  
For Use with On-board Washdown Systems.



**FIG. 504**

**ORDERING INFORMATION**

Pipe Size Inches	O.D. Flange Inches	Display Pkg. - 5 Cards 1 Pc. per Card	OEM Bulk Pkg. 10 Pcs.	Screw Size	Weight Ounces
1/2	2-3/4	504 DP CHR	504 000 CHR	8	8

Spare Cap with Chain, Cat. No. 504 DP 99A.



## SCUPPERS

**FIG. 323 - THRU-HULL SCUPPER**

**MOLDED WHITE PLASTIC  
SOFT BLACK FLAPPER VALVE**

Complete with Nut and Mounting Hardware.  
For Mounting Through the Transom.

**ORDERING INFORMATION**

Hose Size Inches	Maximum Hull Thickness Inches	O.D. Flange Inches	Display Pkg. - 5 Cards 1 Pc. per Card	OEM Bulk Pkg. 50 Pcs.	Weight Ounces
1-1/2	2-1/8	2-7/8	323 DP	323	5

Spare Flanged Nut See Fig. 326, on page 100.



**FIG. 323**



**FIG. 365 - SCUPPER VALVE ASSEMBLY**

**MOLDED WHITE PLASTIC  
SOFT BLACK FLAPPER VALVE**

Without Thru-Hull and Mounting Hardware.  
For Surface Mount Applications.

**ORDERING INFORMATION**

O.D. Flange Inches	Display Pkg. - 5 Cards 1 Pc. per Card	OEM Bulk Pkg. 50 Pcs.	Screw Size	Weight Ounces
2-7/8	365 DP	365	6	1



**FIG. 365**



**FIG. 285 - COCKPIT SCUPPER**

**MOLDED WHITE PLASTIC  
FLUSH MOUNT**

For Use When Discharge is Above the Waterline.  
Insert Prevents Passage of Large Objects  
without Restricting Water Flow.

**ORDERING INFORMATION**

Hose Size Inches	Maximum Hull Thickness Inches	O.D. Flange Inches	I.D. Inches	Display Pkg. - 5 Cards 1 Pc. per Card	OEM Bulk Pkg. 50 Pcs.	Weight Ounces
1-1/2	1-3/4	2-3/4	1-1/2	285 DP	285	5

Spare Flanged Nut See Fig. 326, on page 100.



**FIG. 285**



## SCUPPERS & THRU-HULL CONNECTIONS

**FIG. 142 - COCKPIT SCUPPER**



**CAST BRONZE  
PLAIN OR CHROME PLATED**

**RUBBER CHECK BALL**

Complete with Key  
For Use When Discharge is Below the Waterline.  
Angle of Outlet is 45 Degrees.

**ORDERING INFORMATION**

Hose Size Inches	O.D. Grate Inches	O.D. Flange Inches	Plain Bronze Std. Pkg. - 1 Pc.	Chrome Plated Bronze Std. Pkg. - 1 Pc.	Weight Pounds
1	1-13/16	3-1/4	142 001 PLB	142 001 CHR	1-1/2
1-1/2	2-1/4	3-5/8	142 002 PLB	*142 002 CHR	2-5/8

Screw Size #8  
\* O.E.M. Bulk Pkg. - 10 pcs.

**FIG. 142**

**SPARE PARTS ORDERING INFORMATION**

Hose Size Inches	Plain Bronze Grate	Chrome Plated Bronze Grate	Check Ball Only	Spare Key Only
1	142 P01 99A	142 C01 99A	142 001 99B	1248 7-8 DP
1-1/2	142 P02 99A	142 C02 99A	142 002 99B	1248 7-8 DP



**FIG. 322 - THRU-HULL CONNECTION**



**FIG. 322**

**CAST BRONZE**

Flange is Machined to Fit Hull and  
Grooved to Retain Bedding Compound.  
Neck is Threaded to Approximately 3/8 inches from Flange.



**ORDERING INFORMATION**

Pipe Size Inches	Maximum Hull Thickness Inches	O.D. Flange Inches	Display Pkg. - 5 Cards 1 pc. per Card	Standard Package - 1 Pc.	OEM Bulk Pkg. 25 Pcs.	Weight Pounds
3/8	1-3/4	1-7/16	322 DP3 PLB	-----	322 003 PLB	3/8
1/2	1-3/8	1-1/2	322 DP4 PLB	-----	322 004 PLB	3/8
3/4	1-1/2	1-7/8	322 DP5 PLB	-----	322 005 PLB	1/2
1	1-7/8	2-3/16	322 DP6 PLB	-----	322 006 PLB	7/8
1-1/4	2	2-3/4	322 DP7 PLB	-----	322 007 PLB	1-1/8
1-1/2	2-1/4	3	322 DP8 PLB	-----	*322 008 PLB	1-3/4
2	2-3/8	3-5/8	-----	322 009 PLB	-----	2
2-1/2	2-5/8	4-1/2	-----	322 010 PLB	-----	3-1/2
3	2-3/4	5	-----	322 011 PLB	-----	5

\* O.E.M. Bulk Pkg. - 10 pcs.  
Spare Flanged Nut See Fig. 75, on page 100.



## THRU-HULL CONNECTIONS

**FIG. 348 - EXTRA LONG THRU-HULL CONNECTION**



**CAST BRONZE**

Flange is Machined to Fit Hull and Grooved to Retain Bedding Compound.  
Neck is Threaded to Approximately 3/8 Inch From Flange.

**ORDERING INFORMATION**

Pipe Size Inches	Maximum Hull Thickness Inches	O.D. Flange Inches	Standard Package - 5 Pcs.	OEM Bulk Pkg.	Weight Pounds
3/4	5	1-7/8	348 005 PLB	25	7/8
1	4-7/8	2-1/4	348 006 PLB	10	1-1/4
1-1/4	4-5/8	2-3/4	348 007 PLB	10	2-1/8
1-1/2	4-5/8	3	348 008 PLB	10	2-1/4
2	4-1/2	3-5/8	348 009 PLB	---	3
2-1/2	4-1/4	4-5/16	348 010 PLB	---	4

Spare Flanged Nut See Fig. 75, on page 100.



**FIG. 348**

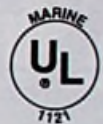

**FIG. 350 - THRU-HULL CONNECTION**



**CAST BRONZE  
PLAIN OR CHROME PLATED  
FOR USE WITH HOSE\*\***



**FIG. 350 CHROME**

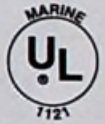

Flange is Machined to Fit Hull and Grooved to Retain Bedding Compound.  
Neck is Threaded to Approximately 3/8 Inch From Flange.

**ORDERING INFORMATION**

Hose Size Inches	Maximum Hull Thickness Inches	O.D. Flange Inches	Plain Bronze Display Pkg. - 5 Cards 1 Pc. per Card	Chrome Plated Bronze Display Pkg. - 5 Cards 1 Pc. per Card	Plain Bronze OEM Bulk Pkg. 10 Pcs.	Chrome Plated Bronze OEM Bulk Pkg. 10 Pcs.	Weight Pounds
5/8	1-1/16	1-1/2	350 004 DPP	350 004 DPC	350 004 PLB	350 004 CHR	3/8
3/4	1-5/8	1-7/8	350 005 DPP	350 005 DPC	350 005 PLB	350 005 CHR	1/2
1	1-3/4	2-1/4	350 006 DPP	350 006 DPC	350 006 PLB	350 006 CHR	7/8
1-1/8	1-3/4	2-1/4	350 06A DPP	350 06A DPC	350 06A PLB	350 06A CHR	7/8
1-1/4	1-7/8	2-3/4	350 007 DPP	350 007 DPC	350 007 PLB	350 007 CHR	1-3/8
1-1/2	1-7/8	3-1/8	350 008 DPP	350 008 DPC	350 008 PLB	350 008 CHR	1-1/2

**FIG. 350 PLAIN**



Spare Flanged Nut See Fig. 75, on page 100.

\*\*NOTE: Thru-Hull Connections For Use With Hose Are Not Recommended For Use Below The Waterline Per A.B.Y.C. "Safety Standards For Small Craft" Section H-27.

## THRU-HULL CONNECTIONS



**Fig. 301**

**FIG. 301 - THRU-HULL CONNECTION**

**MOLDED WHITE PLASTIC**

**NARROW FLANGE**

**FOR USE WITH HOSE\*\***

**ORDERING INFORMATION**

Hose Size Inches	Maximum Hull Thickness Inches	O.D. Flange Inches	Display Pkg. - 10 Cards 1 Pc. per Card	OEM Bulk Pkg. 100 Pcs.	Weight Ounces
1/2	1-1/4	1-1/4	301 DP4	301 004	1
5/8	1-1/4	1-1/4	301 DP4A	301 04A	1
3/4	1-7/16	1-1/2	301 DP5	301 005	1-1/2
1	1-1/2	1-7/8	*301 DP6	***301 006	2
1-1/8	1-1/2	1-7/8	*301 DP6A	***301 06A	2
1-1/2	1-7/8	2-1/2	*301 DP8	***301 008	4

\* Display Pkg. - 5 pcs.

\*\*\* OEM Bulk Pkg. - 50 pcs.

Spare Flanged Nut See Fig. 326.



**Fig. 328**

**FIG. 328 - THRU-HULL CONNECTION**

**MOLDED WHITE PLASTIC**

**BROAD FLANGE**

**FOR USE WITH HOSE\*\***

**ORDERING INFORMATION**

Hose Size Inches	Maximum Hull Thickness Inches	O.D. Flange Inches	Display Pkg. - 10 Cards 1 Pc. per Card	OEM Bulk Pkg. 100 Pcs.	Weight Ounces
1/2	1-1/4	1-1/2	328 DP4	328 004	1
5/8	1-1/4	1-1/2	328 DP4A	328 04A	1
3/4	1-7/16	2-1/16	328 DP5	328 005	1-1/2
1	1-1/2	2-1/4	*328 DP6	***328 006	2
1-1/8	1-1/2	2-1/4	*328 DP6A	***328 06A	2
1-1/2	1-7/8	3	*328 DP8	***328 008	4

\* Display Pkg. - 5 Pcs.

\*\*\* OEM Bulk Pkg. - 50 Pcs.

Spare Flanged Nut See Fig. 326.



**Fig. 75**



**Fig. 326**

**FIG. 75 - SPARE FLANGED LOCK NUT - CAST BRONZE**

**FIG. 326 - SPARE FLANGED LOCK NUT - MOLDED WHITE PLASTIC**

**ORDERING INFORMATION**

Pipe Size Inches	Cast Bronze Nut	Standard Pkg. Pcs.	Molded White Plastic Display Pkg. - 10 Pcs.	Molded White Plastic OEM Bulk Pkg.	Bulk Pkg. Qty.
3/8	75 003 PLB	5	-----	-----	---
1/2	75 004 PLB	5	326 DP4	326 004	100
3/4	75 005 PLB	5	326 DP5	326 005	100
1	75 006 PLB	5	326 DP6	326 006	50
1-1/4	75 007 PLB	5	-----	-----	---
1-1/2	75 008 PLB	1	326 DP8	326 008	50
2	75 009 PLB	1	-----	-----	---
2-1/2	75 010 PLB	1	-----	-----	---
3	75 011 PLB	1	-----	-----	---

\*\*NOTE: Thru-Hull Connections For Use With Hose Are Not Recommended For Use Below The Waterline Per A.B.Y.C. "Safety Standards For Small Craft" Section H-27.



## SEACOCKS

### FIGS. 834 & 835 - SEACOCKS

#### BALL VALVE DESIGN

#### CAST BRONZE

Complete with Thru-Hull, Hose Adapter, Drain Plug, Four Pre-Drilled Mounting Holes and Bonding Screw.

**FIG. 834 - WITH 90° CURVED HOSE ADAPTER.**

**FIG. 835 - WITH STRAIGHT HOSE ADAPTER.**

PERKO Seacocks Incorporate a Plastic Ball and Seat Assuring a Tight Seal and Ease of Operation. Drain Plugs for Winterizing. Handles are Easily Removed.



**FIG. 834**



**FIG. 835**

#### ORDERING INFORMATION

Hose Size Inches	Pipe Size Inches	Fig. 834 Standard Package - 1 Pc.	Fig. 835 Standard Package - 1 Pc.	OEM Bulk Pkg.	Bolt Size	Weight Pounds
3/4	3/4	834 005 PLB	835 005 PLB	5	5/16	3-1/8
1	1	834 006 PLB	835 006 PLB	---	3/8	5-1/8
1-1/4	1-1/4	834 007 PLB	835 007 PLB	5	3/8	6-3/4
1-1/2	1-1/2	834 008 PLB	835 008 PLB	5	3/8	10
2	2	834 009 PLB	835 009 PLB	---	3/8	22
2-1/2	2-1/2	834 010 PLB	835 010 PLB	---	1/2	25
3	3	834 011 PLB	835 011 PLB	---	1/2	32

### FIG. 805 - SEACOCK BODY

#### BALL VALVE DESIGN

#### CAST BRONZE

These Valve Bodies are Offered to Meet the Needs of Applications that Require Extra Long, Scoop or Flush Type Thru-Hulls.

#### ORDERING INFORMATION

Pipe Size Inches	Fig. 805 Standard Package - 1 Pc.	OEM Bulk Pkg.	Weight Pounds
3/4	805 005 PLB	5	2-1/2
1	805 006 PLB	5	4
1-1/4	805 007 PLB	5	5-1/8
1-1/2	805 008 PLB	5	6-3/8
2	805 009 PLB	---	11-3/8
2-1/2	805 010 PLB	---	19
3	805 011 PLB	---	24



**FIG. 805**

#### SPARE PARTS ORDERING INFORMATION

The Repair Kits Listed Below Consist of: 1 Ball, 2 Ball Seats and 2 O-Rings for the Valve Stem.

Pipe Size Inches	Repair Kit	Pipe Size Inches	Repair Kit	Pipe Size Inches	Repair Kit
3/4	805 005 99B	1-1/2	805 008 99B	3	805 011 99B
1	805 006 99B	2	805 009 99B		
1-1/4	805 007 99B	2-1/2	805 010 99B		

## INLINE VALVE & PIPE TO HOSE ADAPTERS

**FIG. 825 - INLINE VALVE**

**CAST BRONZE**

Complete with Drain Plug and Bonding Screw.  
Ball Valve for Smooth Operation.



**Fig. 825**

**ORDERING INFORMATION**

Pipe Size Inches	Standard Package - 1 Pc.	OEM Bulk Pkg.	Weight Pounds
1/2	825 004 PLB	10	1
3/4	825 005 PLB	10	1-1/4
1	825 006 PLB	10	1-3/4
1-1/4	825 007 PLB	10	2-3/4
1-1/2	825 008 PLB	5	4-1/4

**FIG. 63 - PIPE TO HOSE ADAPTER**

**CAST BRONZE**

**CURVED 90 DEGREES**



**Fig. 63**

**ORDERING INFORMATION**

Pipe Size Inches	Hose Size Inches	Length Overall Inches	Standard Package - 1 Pc.	OEM Bulk Pkg.	OEM Bulk Pcs./Pkg.	Weight Pounds
3/4	3/4	4-1/2	-----	63 005 PLB	25	1/2
1	1	4-3/4	-----	63 006 PLB	25	3/4
1-1/4	1-1/4	5-1/2	-----	63 007 PLB	25	1
1-1/2	1-1/2	6	-----	63 008 PLB	10	1-1/4
2	2	7	63 009 PLB	-----	---	2-1/2
2-1/2	2-1/2	8-1/2	63 010 PLB	-----	---	3-7/8
3	3	10	63 011 PLB	-----	---	6-3/8

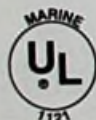

NOTE: The Above Item Meets the Requirements of U.S.C.G. Safety Standards, January 31, 1977 for Gasoline Fuel Systems, 33CFR183.



**FIG. 76 - PIPE TO HOSE ADAPTER**

**CAST BRONZE**

**ORDERING INFORMATION**



**Fig. 76**

Pipe Size Inches	Hose Size Inches	Length Overall Inches	Display Pkg. - 5 Cards 1 Pc. per Card	Standard Package - 1 Pc.	OEM Bulk Pkg. 25 Pcs.	Weight Pounds
1/2	5/8	1-5/8	76 DP4 PLB	-----	76 004 PLB	1/8
3/4	3/4	1-3/4	76 DP5 PLB	-----	76 005 PLB	1/4
1	1	1-3/4	76 DP6 PLB	-----	76 006 PLB	3/8
1-1/4	1-1/4	2	76 DP7 PLB	-----	76 007 PLB	1/2
1-1/2	1-1/2	2-1/4	76 DP8 PLB	-----	76 008 PLB	3/4
2	2	2-5/8	-----	76 009 PLB	-----	1
2-1/2	2-1/2	4	-----	76 010 PLB	-----	2-1/8
3	3	5-1/8	-----	76 011 PLB	-----	3

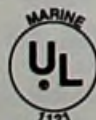

NOTE: The Above Item Meets the Requirements of U.S.C.G. Safety Standards, January 31, 1977 for Gasoline Fuel Systems, 33CFR183.



## STRAINERS

**FIG. 65 - INTAKE STRAINER**

**CAST BRONZE**

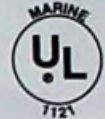

**Fig. 65**

**ORDERING INFORMATION**

Pipe Size Inches	Maximum Hull Thickness Inches	Dimensions Strainer Inches	Display Pkg. - 5 Cards 1 Pc. per Card	OEM Bulk Pkg. 10 Pcs.	Weight Pounds
1/2	2-1/4	3 x 4	-----	65 004 PLB	3/4
3/4	2-3/16	3 x 4	65 DP5 PLB	65 005 PLB	1
1	2-1/2	3 x 4	-----	65 006 PLB	1-1/4
1-1/4	3	3-1/4 x 4-1/4	-----	65 007 PLB	2

Screw Size #8.

Spare Flanged Nut See Fig. 75, on page 100.

**FIG. 66 - SCOOP STRAINER**

**CAST BRONZE**



**Fig. 66**

**ORDERING INFORMATION**

For Thru-Hull Sizes Inches	Dimensions Strainer Inches	Standard Package - 1 Pc.	Weight Pounds
3/8 & 1/2	3-1/2 x 2-1/2	66 001 PLB	1-3/4
3/4 & 1	5 x 3-1/4	66 002 PLB	4-1/2
1-1/4 & 1-1/2	6-1/4 x 4-1/4	66 003 PLB	6-3/8
2	8 x 5-1/8	66 004 PLB	10

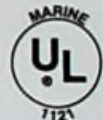

Screw Size #8.

**FIG. 86 - ROUND STRAINER**

**CAST BRONZE**



**Fig. 86**



**ORDERING INFORMATION**

For Thru-Hull Sizes Inches	O.D. Inches	I.D. Inches	Display Pkg. - 5 Cards 1 Pc. per Card	Standard Package - 5 Pcs.	OEM Bulk Pkg. 25 Pcs.	Screw Size	Weight Pounds
3/8 & 1/2	2-1/2	1-5/8	-----	86 001 PLB	-----	8	3/16
3/4	3	2	86 DP2 PLB	-----	86 002 PLB	8	1/4
1	3-1/2	2-3/8	-----	86 003 PLB	86 003 PLB	8	3/8
1-1/4 x 1-1/4	4	3	-----	86 004 PLB	-----	8	1/2
2	5	3-3/4	-----	86 005 PLB	86 005 PLB	8	3/4
2-1/2	6	4-1/2	-----	*86 006 PLB	**86 006 PLB	10	1-1/4
3	8	6-1/4	-----	*86 007 PLB	-----	10	2-1/2

\* Standard Package - 1 pc.

\*\* OEM Bulk Package - 10 pcs.

## PUMP STRAINERS



### FIG. 709 - PUMP STRAINER

**CAST BRONZE**

#### ORDERING INFORMATION



**FIG. 709**

Hose Size Inches	Length Overall Inches	Width Overall Inches	Display Pkg. - 5 Cards 1 Pc. per Card	Weight Ounces
5/8	3-5/8	1-3/4	709 DP PLB	6



**FIG. 704**

### FIG. 704 & 705 - PUMP STRAINERS

**CAST BRONZE**

#### ORDERING INFORMATION



**FIG. 705**

Hose Size Inches	Length Overall Inches	Width Overall Inches	Standard Package - 1 Pc.	Weight Pounds
1-1/4	6-3/8	2-3/4	704 000 PLB	2
1-1/4	4-1/2	2-3/4	705 000 PLB	1-1/2



**FIG. 721**

### FIG. 721 & 722 - PUMP STRAINERS

**CAST BRONZE**

#### ORDERING INFORMATION



**FIG. 722**

Pipe Size Inches	Length Overall Inches	Width Overall Inches	Standard Package - 1 Pc.	Weight Pounds
1-1/4	4-3/4	2-3/4	721 000 PLB	1-3/4
1-1/4	4-1/2	2-3/4	722 000 PLB	1-3/8



## FUEL FILTER & SEPARATOR

**FIG. 299 - FUEL FILTER AND SEPARATOR**

**CAST BRONZE**

**MICROPOROUS FILTER ELEMENT**

Complete with Adjustable Mounting Bracket, Drain Plug and O-Ring.  
These Units Separate Water From Gasoline or Diesel Fuel and  
Filter Out Particles of 40 Microns or Larger in Size.

### ORDERING INFORMATION

Pipe Size Inches	Height Overall Inches	O.D. Overall Inches	Standard Package - 1 Pc.	Dimensions Element Inches	Screw Size	Weight Pounds
3/8	5-1/2	2-3/8	299 001 PLB	1-3/4 x 1-3/4	8	3-3/4
1/2	6-1/4	3-1/8	299 002 PLB	2-1/4 x 2	10	5-1/2

Spare Element and O-Ring for 3/8", Cat. No. 324 001 ELM.  
Spare Element and O-Ring for 1/2", Cat. No. 324 002 ELM.



**FIG. 299**



NOTE: This Item Meets the Requirements of U.S.C.G. Safety Standards, January 31, 1977, for Gasoline Fuel Systems, 33CFR183.

**FIG. 414 - TRANSOM DRAIN PLUG**

**BRASS  
BLACK PLASTIC HANDLE  
EXPANDABLE PLUG**

### ORDERING INFORMATION

I.D. Tube Inches	Length Tube Inches	Length Overall Inches	Display Pkg. - 10 Cards 1 Pc. per Card	Weight Ounces
1	2	2-1/2	414 DP1 PLB	3-1/2

Spare Plug, Cat. No. 414 DP 99A.  
Spare Tube, Cat. No. 414 001 99B.



**FIG. 414**



## GARBOARD DRAIN PLUGS



**FIG. 263 - GARBOARD DRAIN PLUG**

**CAST BRONZE**

**ORDERING INFORMATION**



Pipe Size Inches	Length Threaded Neck Inches	O.D. Flange Inches	Display Pkg. - 5 Cards 1 Pc. per Card	Screw Size	Weight Ounces
3/4	5/8	2-3/8	263 DP PLB	8	12

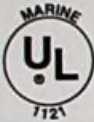

**FIG. 263**

Spare Plug, Cat. No. 370 DP PLB.



**FIG. 266 - GARBOARD DRAIN PLUG**

**CAST BRONZE**

**ORDERING INFORMATION**



Pipe Size Inches	Length Threaded Neck Inches	O.D. Flange Inches	Display Pkg. - 5 Cards 1 Pc. per Card	Screw Size	Weight Ounces
3/4	5/8	2-3/8	266 DP PLB	8	12



**FIG. 266**

Spare Plug, Cat. No. 370 DP PLB.



**FIG. 363 - GARBOARD DRAIN PLUG**

**CAST BRONZE**

**ORDERING INFORMATION**



Pipe Size Inches	Maximum Hull Thickness Inches	Length Threaded Neck Inches	O.D. Flange Inches	Display Pkg. - 5 Cards 1 Pc. per Card	OEM Bulk Pkg. 25 Pcs.	Weight Ounces
3/4	3/4	1-1/4	2-3/8	363 DP PLB	363 000 PLB	15

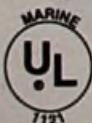

**FIG. 363**

Spare Plug, Cat. No. 370 DP PLB.



## GARBOARD DRAIN PLUGS

### FIG. 714 - GARBOARD DRAIN PLUG

#### CAST BRONZE FLANGE BRASS PLUG

No. 2 Style has Stainless Steel Pin.

#### ORDERING INFORMATION

Pipe Size Inches	O.D. Flange Inches	Display Pkg. - 5 Cards 1 Pc. per Card	OEM Bulk Pkg. 50 Pcs.	Screw Size	Weight Ounces
1/2	2	714 DP1 PLB	714 001 PLB	8	4
1/2	2	714 DP2 PLB	714 002 PLB	8	4

Spare No. 1 Plug, Cat. No. 742 DP1.

Spare No. 2 Plug, Cat. No. 742 DP2.



FIG. 714 No. 1

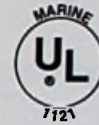

FIG. 714 No. 2

### FIG. 737 - GARBOARD DRAIN PLUG

#### CAST BRONZE FLANGE BRASS PLUG

Complete with Brass Backing Plate and Fasteners.  
No. 2 Style has Stainless Steel Pin.

#### ORDERING INFORMATION

Pipe Size Inches	Maximum Hull Thickness Inches	O.D. Flange Inches	Display Pkg. - 5 Cards 1 Pc. per Card	Screw Size	Weight Ounces
1/2	7/16	2	737 DP1 PLB	8-32	5
1/2	7/16	2	737 DP2 PLB	8-32	5

Spare No. 1 Plug, Cat. No. 742 DP1.

Spare No. 2 Plug, Cat. No. 742 DP2.



FIG. 737 No. 1

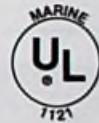

FIG. 737 No. 2

### FIG. 124 - GARBOARD DRAIN PLUG

#### CAST BRONZE FLANGE BRASS PLUG

Complete with Zinc Plated Steel Wrench.

#### ORDERING INFORMATION

Pipe Size Inches	Length Threaded Neck Inches	O.D. Flange Inches	Standard Package - 5 Pcs.	Screw Size	Weight Pounds
1	1	3-1/8	124 000 PLB	10	1-1/4

Spare Wrench, Cat. No. 124 000 99A.

Spare Plug, Cat. No. 124 000 99B.



FIG. 124



## RIGGING TUBE, CAULKING IRON & SCRAPER

**FIG. 357 - RIGGING TUBE**

**CHROME PLATED BRASS AND BRONZE**

For use with 2 Inch I.D. Hose to Pass Wiring Harnesses and Control Cables Through Transoms and Motorwell Bulkheads.

Mounts in 2-1/8 Inch Diameter Hole.



**FIG. 357**

**ORDERING INFORMATION**

O.D. Tube Inches	Length Overall Inches	O.D. Flange Inches	Standard Pkg. - 1 Pcs. OEM Bulk Pkg. - 25 Pcs.	Screw Size	Weight Ounces
2	4-1/8	3-1/8	357 001 CHR	8	12

**FIG. 307 - CAULKING IRON**

**MALLEABLE IRON**

**ORDERING INFORMATION**



**FIG. 307**

Thickness Blade Inches	Width Blade Inches	Length Overall Inches	Standard Package - 10 Pcs.	Weight Ounces
1/32	2	5	307 000	5
1/16	2-1/2	5-5/8	307 00A	6-1/2
1/8	2-1/4	5-7/8	307 001	7

**FIG. 1175 - DOUBLE ENDED SCRAPER**

**HEAT TREATED STEEL**

**ORDERING INFORMATION**

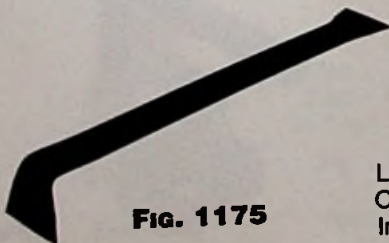

**FIG. 1175**

Length Overall Inches	Width Blade Inches	Width Shank Inches	Thickness Shank Inches	Standard Package - 5 Pcs.	Weight Pounds
15	1-3/4	1	1/4	1175	1



## GLEATS

**FIG. 566 - CLOSED BASE CLEAT**



**CHROME PLATED ZINC**

**ORDERING INFORMATION**

Length Overall Inches	Dimensions Base Inches	Max. Rope Size Inches	Display Pkg. - 5 Cards 2 Pcs. per Card	Screw Size	Weight Ounces
2	2-3/16 x 1-1/8	5/16	566 DP2 CHR	6	1-1/2
3	3-1/8 x 1-1/2	3/8	566 DP3 CHR	8	4-1/2
4-1/2	4-7/16 x 1-7/8	1/2	566 DP4 CHR	10	8-1/2
6	5-1/2 x 2	3/4	*566 DP6 CHR	12	13-1/2



**FIG. 566**

\* Display Pkg. 5 pcs., 1 Pc. per card

**FIG. 1251 - CLOSED BASE CLEAT**



**CHROME PLATED ZINC**

**ORDERING INFORMATION**

Length Overall Inches	Dimensions Base Inches	Max. Rope Size Inches	Display Pkg. - 10 Cards 1 Pc. per Card	Screw Size	Weight Ounces
3	1-3/8 x 1-3/16	3/8	1251 DP3 CHR	8	2-1/3
4-1/2	1-1/2 x 1-1/4	1/2	1251 DP4 CHR	8	6



**FIG. 1251**

**FIG. 1252 - OPEN BASE CLEAT**



**CHROME PLATED ZINC**

**ORDERING INFORMATION**

Length Overall Inches	Dimensions Base Inches	Max. Rope Size Inches	Display Pkg. - 5 Cards 2 Pcs. per Card	OEM Bulk Pkg. 50 Pcs.	Screw Size	Weight Ounces
6-1/2	3 x 1-1/8	3/4	1252 DP CHR	1252 000 CHR	1/4	7



**FIG. 1252**

## CLEATS



**FIG. 572 - OPEN BASE CLEAT**



**FIG. 572**

**CHROME PLATED BRONZE**

**ORDERING INFORMATION**

Length Overall Inches	Dimensions Base Inches	Max. Rope Size Inches	Display Pkg. - 5 Cards 1 Pc. per Card	Standard Package - 10 Pcs.	OEM Bulk Pkg. 10 Pcs.	Screw Size	Weight Pounds
*6-1/2	3-5/16 x 1-7/8	1/2	572 DP6 CHR	-----	572 06A CHR	12	3/4
8	4 x 2-1/4	3/4	572 DP8 CHR	-----	572 008 CHR	1/4	1-1/4
10	5-1/16 x 2-13/16	7/8	-----	**572 010 CHR	-----	5/16	1-3/4
12	6-1/16 x 2-7/8	1	-----	**572 012 CHR	-----	5/16	2-1/2

\* This Size is Solid, Balance of Sizes Are Hollow.

\*\* Standard Package, 1 pc.



**FIG. 1188 - OPEN BASE CLEAT**



**FIG. 1188**

**CHROME PLATED ZINC**

**ORDERING INFORMATION**

Length Overall Inches	Dimensions Base Inches	Max. Rope Size Inches	Display Pkg. - 5 Cards 1 Pc. per Card	Catalog Number	Std. Pkg.	OEM Bulk Pkg.	Screw Size	Weight Pounds
4	2-1/8 x 1-1/2	5/16	*1188 DP4 CHR	1188 004 CHR	---	50	10	1/4
6	3 x 1-3/4	7/16	1188 DP6 CHR	1188 006 CHR	---	50	10	1/2
8	4 x 2-1/8	5/8	1188 DP8 CHR	1188 008 CHR	---	25	1/4	3/4
10	5 x 2-3/8	7/8	-----	1188 010 CHR	1	10	1/4	1-1/2
12	6 x 3	1	-----	1188 012 CHR	1	10	5/16	2-1/2

\* Display Package, 5 cards - 2 Pcs. per card.

**FIG. 1210 - OPEN BASE CLEAT**

**CHROME PLATED ZINC  
ZINC PLATED STEEL STUDS,  
NUTS AND WASHERS**



**FIG. 1210**

**ORDERING INFORMATION**

Length Overall Inches	Dimensions Base Inches	Max. Rope Size Inches	Catalog Number	Std. Pkg.	OEM Bulk Pkg.	Stud Size	Weight Ounces
4	2-1/8 x 1-1/2	5/16	1210 004 CHR	10	50	12-24 x 1-1/4	5-1/2
6	3 x 1-3/4	7/16	1210 006 CHR	10	30	1/4-20 x 2	8
8	4 x 2-1/8	5/8	1210 008 CHR	5	30	1/4-20 x 2	12-1/2



## GLEATS

**FIG. 530 - OPEN BASE GLEAT**



**PLAIN ALUMINUM**

**ORDERING INFORMATION**

Length Overall Inches	Dimensions Base Inches	Max. Rope Size Inches	Standard Package - 1 Pc.	Screw Size	Weight Pounds
8	4 x 2-1/4	3/4	530 008 ALU	1/2	1-1/8
10	4-1/2 x 3	7/8	530 010 ALU	1/2	1-3/4
12	6-1/2 x 2-7/8	1	530 012 ALU	5/8	3-1/2
15	7 x 3-1/4	1-1/2	530 015 ALU	3/4	4-7/8



**Fig. 530**

**FIG. 545 - GLEAT**



**PLAIN ALUMINUM**

**ORDERING INFORMATION**

Length Overall Inches	Dimensions Base Inches	Max. Rope Size Inches	Display Pkg. - 5 Cards 2 Pcs. per Card	Standard Package - 5 Pcs.	Screw Size	Weight Ounces
3	1-1/2 x 5/8	1/4	545 DP3 ALU	-----	8	1-1/2
4	1-5/8 x 3/4	5/16	545 DP4 ALU	-----	10	2
5	2 x 7/8	3/8	545 DP5 ALU	-----	1/4	3
6	2-1/4 x 7/8	7/16	**545 DP6 ALU	-----	1/4	4
*8	2-5/8 x 1-7/8	5/8	**545 DP8 ALU	-----	1/4	5
*10	3-5/8 x 1-1/2	3/4	-----	545 010 ALU	5/16	9
*12	4 x 1-1/2	7/8	-----	545 012 ALU	5/16	14



**Fig. 545**



\* These Sizes are Open Base, Balance of Sizes are Closed Base.  
\*\* Display Package, 10 pcs., 1 Pc. per card.

**FIG. 544 - GLEAT**



**CAST BRONZE  
POLISHED OR CHROME PLATED**

**ORDERING INFORMATION**

Length Overall Inches	Dimensions Base Inches	Max. Rope Size Display Pkg.	Chrome Plated Bronze Display Pkg.	Display Pkg. - 5 Cards Pcs. per Card	Polished Bronze Standard Pkg.	Chrome Plated Bronze Standard Pkg.	Std. Pkg.	Screw Size
3	1-1/2 x 5/8	1/4	544 DP3 CHR	2	544 003 POL	-----	10	8
4	1-5/8 x 3/4	5/16	544 DP4 CHR	1	544 004 POL	-----	5	10
5	2 x 7/8	3/8	-----	---	544 005 POL	544 005 CHR	5	1/4
6	2-1/4 x 7/8	1/2	-----	---	544 006 POL	544 006 CHR	5	1/4
*8	2-5/8 x 1-1/2	3/4	-----	---	544 008 POL	**544 008 CHR	1	1/4



**Fig. 544**



\* This Size is Open Base, Balance of Sizes are Closed Base.  
\*\* O.E.M. Bulk Package, 10 pcs.



**FIG. 1305 - CLOSED BASE CLEAT**

**CHROME PLATED ZINC  
BLACK PLASTIC BASE**



**chromalex®**

**Fig. 1305**

**ORDERING INFORMATION**

Length Overall Inches	Max. Rope Size Inches	Display Package	Display Pkg. - 5 Cards Pcs. per Card	OEM Bulk Pkg. 50 Pcs.	Screw Size	Weight Ounces
4-1/2	3/8	1305 DP1 CHR	2	1305 001 CHR	10	5
6	1/2	1305 DP2 CHR	1	1305 002 CHR	1/4	10

**FIG. 1315 - CLOSED BASE CLEAT**

**CHROME PLATED ZINC  
BLACK PLASTIC BASE  
ZINC PLATED STEEL STUDS, NUTS AND WASHERS**



**chromalex®**

**Fig. 1315**

**ORDERING INFORMATION**

Length Overall Inches	Max. Rope Size Inches	Catalog Number	Standard Package	OEM Bulk Package	Stud Size	Weight Ounces
4-1/2	3/8	1315 001 CHR	10	50	12-24 x 1-1/2	6-1/2
6	1/2	1315 002 CHR	5	40	1/4 x 1-1/2	12



**FIG. 1316 - OPEN BASE CLEAT**

**CHROME PLATED ZINC  
BLACK PLASTIC BASE  
ZINC PLATED STEEL STUDS, NUTS AND WASHERS**



**FIG. 1316**

**chromalex**

**ORDERING INFORMATION**

Length Overall Inches	Max. Rope Size Inches	Catalog Number	Std. Pkg.	OEM Bulk Pkg.	Stud Size	Weight Ounces
4-1/2	3/8	1316 001 CHR	10	50	12-24 x 1-1/2	5
6	1/2	1316 002 CHR	5	40	1/4 x 1-1/2	10-1/2

**FIG. 1416 - OPEN BASE CLEAT**

**CHROME PLATED ZINC  
BLACK PLASTIC BASE AND INSERT  
ZINC PLATED STEEL STUDS, NUTS AND WASHERS**



**FIG. 1416**

**chromalex**

**ORDERING INFORMATION**

Length Overall Inches	Max. Rope Size Inches	Catalog Number	Std. Pkg.	OEM Bulk Pkg.	Stud Size	Weight Ounces
4-1/2	3/8	1416 001 CHR	10	50	12-24 x 1-1/2	5
6	1/2	1416 002 CHR	5	40	1/4 x 1-1/2	10-1/2
8	3/4	1416 003 CHR	1	30	1/4 x 1-1/2	13

## CLEATS



**FIG. 1306 - OPEN BASE CLEAT**



**CHROME PLATED ZINC  
BLACK PLASTIC BASE**

**chromolex®**

**Fig. 1306**

**ORDERING INFORMATION**

Length Overall Inches	Max. Rope Size Inches	Display Package	Display Pkg. - 5 Cards Pcs. per Card	OEM Bulk Pkg. 50 Pcs.	Screw Size	Weight Ounces
4-1/2	3/8	1306 DP1 CHR	2	1306 001 CHR	10	4
6	1/2	1306 DP2 CHR	1	1306 002 CHR	1/4	8-1/2



**FIG. 1406 - OPEN BASE CLEAT**



**CHROME PLATED ZINC  
BLACK PLASTIC BASE AND INSERT**

**chromolex®**

**Fig. 1406**

**ORDERING INFORMATION**

Length Overall Inches	Max. Rope Size Inches	Display Package	Display Pkg. - 5 Cards Pcs. per Card	OEM Bulk Pkg. 50 Pcs.	Screw Size	Weight Ounces
4-1/2	3/8	1406 DP1 CHR	2	1406 001 CHR	10	4
6	1/2	1406 DP2 CHR	1	1406 002 CHR	1/4	8-1/2
8	3/4	-----	---	1406 003 CHR	1/4	11



**FIG. 1326 - OPEN BASE CLEAT**



**CHROME PLATED ZINC  
BLACK PLASTIC BASE**

**chromolex®**

**Fig. 1326**

**ORDERING INFORMATION**

Length Overall Inches	Dimensions Base Inches	Max. Rope Size Inches	Display Pkg. - 5 Cards 1 Pc. per Card	OEM Bulk Pkg. 50 Pcs.	Screw Size	Weight Ounces
5-3/4	3-5/8 x 7/8	1/2	1326 DP2 CHR	1326 002 CHR	1/4	9



**FIG. 573 - OPEN BASE CLEAT**



**CHROME PLATED BRONZE  
BLACK PLASTIC BASE**

**chromolex®**

**Fig. 573**

**ORDERING INFORMATION**

Length Overall Inches	Dimensions Base Inches	Max. Rope Size Inches	Display Pkg. - 5 Cards 1 Pc. per Card	OEM Bulk Pkg. 25 Pcs.	Screw Size	Weight Ounces
6	3-5/8 x 7/8	1/2	573 DP6 CHR	573 006 CHR	1/4	9



## CHOCKS



### FIG. 546 - BOW CHOCKS

**CHROME PLATED BRONZE**

#### ORDERING INFORMATION

Max. Rope Size Inches	Length Overall Inches	Width Inches	Display Pkg. - 5 Cards 1 Pair per Card	Screw Size	Weight per Pair Pounds
5/8	4	3/4	546 DP4 CHR	10	1/2



**Fig. 546**



### FIG. 1223 - SKENE BOW CHOCKS

**CHROME PLATED ZINC**

#### ORDERING INFORMATION

Max. Rope Size Inches	Length Overall Inches	Width Inches	Display Pkg. - 5 Cards 1 Pair per Card	OEM Bulk Pkg. 50 Pair	Screw Size	Weight per Pair Ounces
1/2	3-1/2	7/8	1223 DP CHR	1223 000 CHR	8	4



**Fig. 1223**



### FIG. 119 - STRAIGHT CHOCK

**CHROME PLATED BRONZE**

#### ORDERING INFORMATION

Maximum Rope Size Inches	Length Overall Inches	Width Inches	Display Pkg. - 5 Cards 1 Pc. per Card	Screw Size	Weight Each Pounds
3/4	4	7/8	119 DP4 CHR	8	1/4
1	6	1-1/8	119 DP6 CHR	12	3/4



**Fig. 119**

## CHOCKS



**Fig. 1230**

**FIG. 1230 - STRAIGHT CHOCKS**

**CHROME PLATED ZINC**

**ORDERING INFORMATION**

Maximum Rope Size Inches	Length Overall Inches	Width Inches	Display Pkg. - 10 Cards 1 Pair per Card	OEM Bulk Pkg. 50 Pair	Screw Size	Weight per Pair Ounces
3/4	4	7/8	1230 DP CHR	1230 000 CHR	8	6



**Fig. 1307**

**FIG. 1307 - SKENE CHOCKS**

**CHROME PLATED ZINC  
BLACK PLASTIC BASE**

**chromalex®**

**ORDERING INFORMATION**

Maximum Rope Size Inches	Length Overall Inches	Width Inches	Display Pkg. - 5 Cards 1 Pair per Card	Screw Size	Weight per Pair Pounds
3/8	3-1/2	7/8	1307 DP1 CHR	10	5
1/2	5	1-1/4	1307 DP2 CHR	1/4	12



**Fig. 1308**

**FIG. 1308 - STRAIGHT CHOCKS**

**CHROME PLATED ZINC  
BLACK PLASTIC BASE**

**chromalex®**

**ORDERING INFORMATION**

Maximum Rope Size Inches	Length Overall Inches	Width Inches	Display Pkg. - 5 Cards 1 Pair per Card	Screw Size	Weight per Pair Ounces
3/8	3-1/2	7/8	1308 DP1 CHR	10	5
1/2	5	1-1/4	1308 DP2 CHR	1/4	12



## MOORING BITT & HAWSE HOLE PLATES

**FIG. 608 - MOORING BITT**

**CHROME PLATED BRONZE  
HOLLOW**

**ORDERING INFORMATION**

Dimensions Base Inches	Height Inches	Standard Pkg. 1 Pc.	Bolt Size	Weight Pounds
3 x 3	2-1/2	608 001 CHR	10	7/8
4-1/4 x 4-1/4	3-1/2	608 002 CHR	1/4	1-7/8
5 x 5	4-3/4	608 02A CHR	3/8	3-1/2
6 x 6	5	608 003 CHR	3/8	4-1/2



**FIG. 608**

**FIG. 1250 - HAWSE HOLE PLATE**

**CHROME PLATED ZINC**

**ORDERING INFORMATION**

Dimensions Outside Inches	Dimensions Inside Inches	Length Spigot Inches	Std. Pkg. - 1 Pc. OEM Pkg. - 10 Pcs.	Screw Size	Weight Pounds
3-5/8 x 5-5/8	2-1/16 x 4-1/16	1	1250 000 CHR	1/4	3/4



**FIG. 1250**

**FIG. 752 - HAWSE HOLE PLATE**

**CHROME PLATED BRONZE**

**ORDERING INFORMATION**

Dimensions Outside Inches	Dimensions Inside Inches	Length Spigot Inches	Std. Pkg. - 1 Pc. OEM Pkg. - 10 Pcs.	Screw Size	Weight Pounds
4-1/4 x 6	2-1/8 x 4-1/8	1-1/4	752 000 CHR	1/4	1-1/2



**FIG. 752**

## DECK PIPES



### FIG. 750 - ROPE AND CHAIN DECK PIPE

#### CHROME PLATED BRONZE

The Cover Has a Hook for Hanging Chain and a Stainless Steel Cable Retainer.



FIG. 750

#### ORDERING INFORMATION

Opening For Chain Size Inches	Dimensions Flange Inches	Height Overall Inches	Display Pkg. - 5 Cards 1 Pc. per Card	Screw Size	Weight Pounds
3/8	5-1/4 x 4	1-3/8	750 DP CHR	8	2

Spare Cover with Hook and Cable, Cat. No. 750 DP 99A



### FIG. 1057 - ROPE DECK PIPE

#### U.V. STABILIZED, FIBER REINFORCED HIGH IMPACT BLACK OR WHITE PLASTIC

Hinged, Snap-Down Cover



FIG. 1057 WHT



FIG. 1057 BLK

#### ORDERING INFORMATION

Color	Maximum Rope Size Inches	O.D. Flange Inches	Display Pkg. - 5 Cards 1 Pc. per Card	OEM Bulk Pkg. 25 Pcs.	Screw Size	Weight Ounces
Black	7/8	3-3/4	1057 DP BLK	1057 000 BLK	8	3-1/4
White	7/8	3-3/4	1057 DP WHT	1057 000 WHT	8	3-1/4



### FIG. 741 - ROPE DECK PIPE

#### CHROME PLATED BRONZE

#### ORDERING INFORMATION



FIG. 741

Maximum Rope Size Inches	O.D. Flange Inches	Display Pkg. - 5 Cards 1 Pc. per Card	OEM Bulk Pkg. 10 Pcs.	Screw Size	Weight Pounds
5/8	3	741 DP0 CHR	741 000 CHR	8	3/4

Spare No. 0 Cap with Chain, Cat. No. 741 DP0 99A.



### FIG. 757 - ROPE DECK PIPE

#### CHROME PLATED ZINC

#### ORDERING INFORMATION



FIG. 757

Maximum Rope Size Inches	O.D. Flange Inches	Display Pkg. - 5 Cards 1 Pc. per Card	OEM Bulk Pkg. 10 Pcs.	Screw Size	Weight Pounds
1	3-3/8	757 DP CHR	757 000 CHR	8	1/2



## ANCHOR CHOCKS

**CHROME PLATED BRONZE  
POLISHED OR BURNISHED**



Size No. 1 Fits	
<b>Fortress Models</b> FX7-FX16	<b>Danforth® Models</b> H <sup>®</sup> 500    T <sup>™</sup> 570 H <sup>®</sup> 960    T <sup>™</sup> 1200 H <sup>®</sup> 1500   T <sup>™</sup> 1800 S <sup>®</sup> 160    T <sup>™</sup> 2500 S <sup>®</sup> 300    T <sup>™</sup> 3000
<b>U.S. Anchor Mfg., INC. Models</b> 2-1/2, 4, 8, 13	S <sup>®</sup> 600    D <sup>™</sup> 375 S <sup>®</sup> 920    D <sup>™</sup> 750 S <sup>®</sup> 1300   D <sup>™</sup> 1150 VSB <sup>™</sup> 160   D <sup>™</sup> 1650 VSB <sup>™</sup> 13000 VSB <sup>™</sup> 1900
Size No. 2 Fits	
<b>Fortress Models</b> FX23-FX55	<b>Danforth® Models</b> H <sup>®</sup> 1800   T <sup>™</sup> 4000 H <sup>®</sup> 3100   T <sup>™</sup> 6000 H <sup>®</sup> 3600   T <sup>™</sup> 7000 D <sup>™</sup> 2000 D <sup>™</sup> 2500
<b>U.S. Anchor Mfg., INC. Models</b> 18 & 22	S <sup>®</sup> 1600 S <sup>®</sup> 2000 S <sup>®</sup> 3000 VSB <sup>™</sup> 2500 VSB <sup>™</sup> 3600



**Fig. 903**

### ORDERING INFORMATION

Polished Chrome Plated Bronze	Burnished Chrome Plated Bronze	Screw Size	Weight Per Set Pounds
Display Pkg. - 5 Cards 1 Set per Card	Display Pkg. - 5 Cards 1 Set per Card		
903 DP1 CHR	903 DP1 BUR	10	2
903 DP2 CHR	903 DP2 BUR	10	2-1/4

### SPARE PARTS ORDERING INFORMATION

To Specify Size Replace the Sixth Digit With the Size Number (i.e. 903 001 99A or 903 B01 99A).

Spare Polished Chrome Shank Support, Cat. No. 903 000 99A.  
Spare Pair, Polished Chrome Fluke Supports, Cat. No. 903 000 99B.  
Spare Polished Chrome Crown Support, Cat. No. 903 000 99C.  
Spare Knob, Cat. No. 1144 A00 BLK.

Spare Burnished Chrome Shank Support, Cat. No. 903 B00 99A.  
Spare Pair, Burnished Chrome Fluke Supports, Cat. No. 903 B00 99B.  
Spare Burnished Chrome Crown Support, Cat. No. 903 B00 99C.

### Fig. 759 - DOCK LINE SPRING

**GALVANIZED SPRING STEEL**



**Fig. 759**

### ORDERING INFORMATION

For Rope Size Inches	Length Overall Inches	O.D. Inches	Compression Inches	Standard Package - 5 Pcs.	Weight Pounds
1/2	10	1-1/2	4-1/2	759 001 ZNC	7/8

## BOW & TRANSOM EYES

**NOTE: THE BOW EYES AND TRANSOM EYES ILLUSTRATED ON THIS PAGE ARE NOT DESIGNED TO BEAR THE WEIGHT OF THE VESSEL AND THEREFORE SHOULD NOT BE USED FOR LIFTING.**

**FIG. 237 - BOW EYE**



**NON-MAGNETIC 300 SERIES STAINLESS STEEL SHANK  
STAINLESS STEEL NUTS & WASHERS**

**ORDERING INFORMATION**



**FIG. 237**

Length Shank Inches	O.D. Shank Inches	I.D. Eye Inches	Length Thread Inches	Display Pkg. - 10 Cards 1 Pc. per Card	Weight Ounces	Safe Working Load Pounds
3	5/16	1	3	237 DP1 STS	4	1800
6	5/16	1	6	237 DP2 STS	5-1/2	1800
3	3/8	1-1/8	3	*237 DP3 STS	5	3000
3-1/4	1/2	1-1/2	3-1/4	*237 DP4 STS	12	4600

\* Display Pkg., 5 cards, 1 Pc. per card



**FIG. 1235 - BOW EYE**



**CHROME PLATED ZINC EYE  
ZINC PLATED STEEL "U" BOLT, NUTS & WASHERS**

**SAFE WORKING LOAD 2000 POUNDS**

**ORDERING INFORMATION**

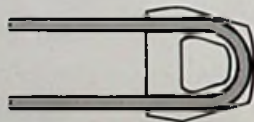

**FIG. 1235**

Length Shank Inches	O.D. Shank Inches	I.D. Eye Inches	Length Thread Inches	Display Pkg. - 10 Cards 1 Pc. per Card	Weight Ounces
3	5/16	1	2-3/4	1235 DP CHR	11



**FIG. 236 - TRANSOM EYE**

**NON-MAGNETIC 300 SERIES STAINLESS STEEL SHANK  
STAINLESS STEEL FINISHING PLATE, NUTS & WASHERS**

For Use as Towing or Lashing Eye.

**ORDERING INFORMATION**



**FIG. 236**

Length Shank Inches	O.D. Shank Inches	I.D. Eye Inches	Dimensions Plate Inches	Display Pkg. - 5 Cards 1 Pc. per Card	Weight Ounces	Safe Working Load Pounds
3	5/16	1	3 x 1-3/4	*236 DP1 STS	6	1800
3	5/16	1-1/8	3 x 1-3/4	236 DP3 STS	10	3000
3-1/4	1/2	1-1/2	4 x 1-3/4	236 DP4 STS	14-1/2	4600

\* Display Pkg., 10 cards, 1 Pc. per card

**IMPORTANT NOTE: THE SAFE WORKING LOAD INFORMATION GIVEN FOR THE ITEMS ABOVE IS BASED ON A STRAIGHT AXIAL PULL. THIS INFORMATION WOULD NOT APPLY IN CASES WHERE INSTALLATION OR USE CREATES ANGULAR LOADING SINCE THESE VARIATIONS MAKE IT IMPRACTICABLE TO OFFER ACCURATE TEST DATA.**



**WATER SKI TOWING HOOK, LIFTING EYES & CLEAT, AND STEP PLATE**

**FIG. 863 - WATER SKI TOWING HOOK**

**CHROME PLATED ZINC BODY  
ZINC PLATED STEEL SHANK, NUTS & WASHERS**

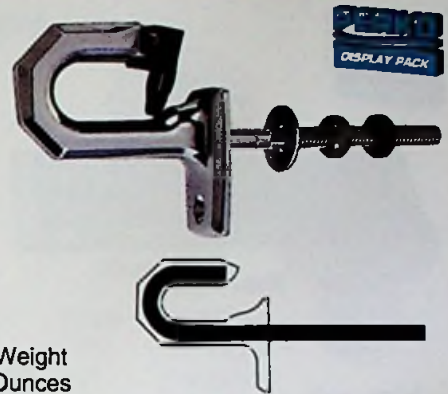

**ORDERING INFORMATION**

Length Overall Inches	Length Shank Inches	O.D. Shank Inches	Length Thread Inches	Display Pkg. - 5 Cards 1 Pc. per Card	Weight Ounces
6	3-1/4	5/16	2-1/2	863 DP CHR	10

**FIG. 863**

**FIG. 429 - LIFTING EYE**

**CHROME PLATED MANGANESE BRONZE  
INTEGRAL FLANGE  
SAFE WORKING LOAD 3000 POUNDS**



**ORDERING INFORMATION**

For Rod Threaded Inches	I.D. Eye Inches	O.D. Eye Inches	O.D. Base Inches	Standard Pkg. - 1 Pc.	Screw Size	Weight Ounces
5/8 x 11	1-1/2	2-1/4	2-1/4	429 000 CHR	8	19

**FIG. 429**

**FIG. 434 - LIFTING EYE AND CLEAT**

**CHROME PLATED MANGANESE BRONZE  
SAFE WORKING LOAD 4000 POUNDS**



**ORDERING INFORMATION**

For Rod Threaded Inches	I.D. Eye Inches	Length Overall Inches	Dimensions Base Inches	Display Pkg. - 5 Cards 1 Pc. per Card	Screw Size	Weight Ounces
5/8 x 11	1-1/16	5-1/16	3-1/2 x 2-1/2	434 DP CHR	10	18

**FIG. 434**

**IMPORTANT NOTE: THE SAFE WORKING LOAD INFORMATION GIVEN FOR THE ITEMS ABOVE IS BASED ON A STRAIGHT AXIAL PULL. THIS INFORMATION WOULD NOT APPLY IN CASES WHERE INSTALLATION OR USE CREATES ANGULAR LOADING SINCE THESE VARIATIONS MAKE IT IMPRACTICABLE TO OFFER ACCURATE TEST DATA.**



**FIG. 1015 - STEP PLATE**

**CHROME PLATED BRASS FRAME  
SOFT BLACK PLASTIC TREAD INSERT**



**ORDERING INFORMATION**

Dimensions Inches	Display Pkg. - 5 Cards 2 Pcs. per Card	O.E.M. Bulk Pkg. 50 Pcs.	Screw Size	Weight Ounces
7-1/4 x 1-1/2	1015 DP CHR	1015 000 CHR	8	2

**FIG. 1015**

## STEP PLATES & STEPS



**Fig. 1043**

### FIG. 1043 - STEP PLATES

**CHROME PLATED BRONZE FRAMES  
SOFT BLACK PLASTIC PADS**

#### ORDERING INFORMATION

Dimensions Inches	Display Pkg. - 5 Cards 1 Pc. per Card	Screw Size	Weight Ounces
8-3/4 x 3-1/4	1043 DP1 CHR	6	8
11-1/2 x 5-3/4	1043 DP2 CHR	8	12

Spare Pads for Size No. 1 (2 per bag), Cat. No. 1050 DP1 BLK.  
Spare Pads for Size No. 2 (2 per bag), Cat. No. 1050 DP2 BLK.



**Fig. 1325**

### FIG. 1325 - STEP PLATES

**CHROME PLATED ZINC FRAMES  
SOFT BLACK PLASTIC PADS**

#### ORDERING INFORMATION

Dimensions Inches	Display Pkg. - 5 Cards 2 Pcs. per Card	OEM Bulk Pkg. 50 Pcs.	Screw Size	Weight Ounces
8-3/8 x 2-1/4	1325 DP0 CHR	1325 000 CHR	8	5
8-3/4 x 3-1/4	1325 DP1 CHR	1325 001 CHR	8	8

Spare Pads for Size No. 0 (2 per bag), Cat. No. 1050 DP0 BLK.  
Spare Pads for Size No. 1 (2 per bag), Cat. No. 1050 DP1 BLK.



**Fig. 351**

### FIG. 351 & 501 - FIXED STEPS

**CHROME PLATED BRONZE**

#### ORDERING INFORMATION



**Fig. 501**

Dimensions Step Inches	Dimensions Bracket Inches	Display Pkg. - 5 Cards 1 Pc. per Card	Standard Package - 1 Pc.	Bolt Size	Weight Pounds
6 x 4-1/4	6 x 2	351 DP CHR	-----	5/16 R.H.	1-1/8
11 x 4-1/2	11 x 2	-----	501 000 CHR	5/16 R.H.	2-7/8



**Fig. 344**

### FIG. 344 - FOLDING STEPS

**CHROME PLATED BRONZE**

Stainless Steel Spring Holds Steps  
in Open or Closed Position.

#### ORDERING INFORMATION

Dimensions Step Inches	Dimensions Bracket Inches	Projection Folded Inches	Display Pkg. - 5 Cards 1 Pc. per Card	Bolt Size	Weight Pounds
4-1/8 x 2-1/4	4-1/4 x 1-3/4	1-3/8	344 DP CHR	5/16 R.H.	1-1/2



## FLAG POLE SOCKETS & FLAG STAFF

### FIG. 218 & 219 - FLUSH FLAG POLE SOCKETS

**CHROME PLATED BRONZE**

**FIG. 218 - BOW SOCKET**

**FIG. 219 - STERN SOCKET**

#### ORDERING INFORMATION

I.D. Socket Inches	O.D. Flange Inches	Depth Socket Inches	Fig. 218 Display Pkg. - 5 Cards 1 Pc. per Card	Fig. 219 Display Pkg. - 5 Cards 1 Pc. per Card	Screw Size	Weight Ounces
3/4	2	1-1/2	218 DP1 CHR	219 DP1 CHR	8	4-1/2
1	2-3/8	1-3/4	218 DP2 CHR	219 DP2 CHR	8	5
1-1/4	2-5/8	2	218 DP3 CHR	219 DP3 CHR	8	9



**FIG. 219  
STERN**



**FIG. 218  
Bow**

### FIG. 220 & 221 - UPRIGHT FLAG POLE SOCKETS

**CHROME PLATED BRONZE**

**FIG. 220 - BOW SOCKET**

**FIG. 221 - STERN SOCKET**

#### ORDERING INFORMATION

I.D. Socket Inches	O.D. Base Inches	Height Overall Inches	Fig. 220 Display Pkg. - 5 Cards 1 Pc. per Card	Fig. 221 Display Pkg. - 5 Cards 1 Pc. per Card	Screw Size	Weight Ounces
3/4	2-1/8	1-3/4	220 DP1 CHR	221 DP1 CHR	8	5-1/4
1	2-1/2	2	220 DP2 CHR	221 DP2 CHR	8	6-3/4
1-1/4	2-3/4	2-1/8	220 DP3 CHR	221 DP3 CHR	8	10-3/4



**FIG. 220  
Bow**



**FIG. 221  
STERN**

### FIG. 1302 - CLAMP-ON FLAG POLE SOCKET

**CHROME PLATED ZINC  
BLACK PLASTIC KNOB**

For Rail Sizes 3/4 to 1 Inch.

#### ORDERING INFORMATION

I.D. Socket Inches	Dimensions Bracket Inches	Display Pkg. - 5 Cards 1 Pc. per Card	Weight Ounces
3/4	2 x 1-3/4	1302 DP CHR	11



**FIG. 1302**

### FIG. 495 - FLAG STAFF

**CHROME PLATED ZINC BASE AND TOP  
ANODIZED ALUMINUM TUBE**

Sizes 2 and 3 For Use With Fig. 1302 Clamp-On Socket Only.

#### ORDERING INFORMATION

O.D. Base Inches	Length Overall Inches	Display Pkg. - 5 Bags 1 Pc. per Bag	Weight Ounces
1/2	14	495 DP1 CHR	3
3/4	14	495 DP2 CHR	4
3/4	18	495 DP3 CHR	5

**FIG. 495**

## HANDLES



**Fig. 1336**

**FIG. 1336 - HANDLES**

**CHROME PLATED ZINC  
BLACK PLASTIC BASE**

**chromalex®**

**ORDERING INFORMATION**

Length Overall Inches	Length Inside Inches	Height Inside Inches	Display Pkg. - 5 Cards 2 Pcs. per Card	OEM Bulk Pkg. 50 Pcs.	Screw Size	Weight Ounces
6-1/4	3-1/2	1	1336 DP CHR	1336 000 CHR	1/4	10



**Fig. 1346**

**FIG. 1346 - HANDLES**

**CHROME PLATED ZINC  
BLACK PLASTIC BASE**

**chromalex®**

**ORDERING INFORMATION**

Length Overall Inches	Length Inside Inches	Height Inside Inches	Std. Pkg. - 10 Pcs. OEM Bulk Pkg. - 50 Pcs.	Stud Size	Weight Ounces
6-1/4	3-1/2	1	1346 000 CHR	1/4 - 20 x 1-1/2	11

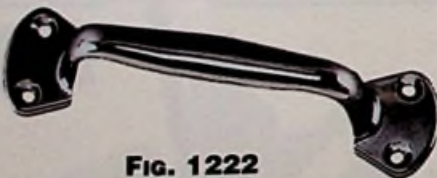

**Fig. 1222**

**FIG. 1222 - HANDLE**

**CHROME PLATED ZINC**

**ORDERING INFORMATION**

Length Overall Inches	Length Inside Inches	Height Inside Inches	Display Pkg. - 5 Cards 2 pcs. per Card	OEM Bulk Pkg. 100 Pcs.	Screw Size	Weight Ounces
5-3/4	3-5/8	1-1/4	1222 DP CHR	1222 000 CHR	8	3-1/2



## HANDLES & GRAB RAIL

**FIG. 1231 - HANDLE**



**CHROME PLATED ZINC**



**FIG. 1231**

**ORDERING INFORMATION**

Length Overall Inches	Length Inside Inches	Height Inside Inches	Display Pkg. - 5 Cards 2 pcs. per Pard	OEM Bulk Pkg. 50 Pcs.	Screw Size	Weight Ounces
6	3-1/2	1-5/16	1231 DP CHR	1231 000 CHR	1/4	7-1/4

**FIG. 775 - HANDLE**



**CHROME PLATED BRONZE**



**FIG. 775**

**ORDERING INFORMATION**

Length Overall Inches	Length Inside Inches	Height Inside Inches	Display Pkg. - 5 Cards 2 pcs. per Card	OEM Bulk Pkg. 50 Pcs.	Screw Size	Weight Ounces
4-1/4	2-1/2	7/8	775 DP1 CHR	775 001 CHR	6	2
5-3/4	3-5/8	1-3/8	775 DP2 CHR	775 002 CHR	8	4

**FIG. 491 - GRAB RAIL**



**CHROME PLATED ZINC END POSTS**

**POLISHED 18-8 STAINLESS STEEL TUBE**



**FIG. 491**

**ORDERING INFORMATION**

Length Overall Inches	Length Inside Inches	Height Inside Inches	Display Pkg. - 5 Cards 1 pc. per Card	Screw Size	Weight Pounds
9-1/2	7	3/4	491 DP1 CHR	6	3/4
15-5/8	13	3/4	491 DP2 CHR	6	1

## GRAB RAIL POSTS

### FIG. 1297 & 1298 - GRAB RAIL POSTS

**CHROME PLATED ZINC**

**FIG. 1297 - END POST**  
**FIG. 1298 - CENTER POST**



**FIG. 1297**  
**END POST**



**FIG. 1298**  
**CENTER POST**

Hollow, For 3/4 Inch O.D. Tubing

#### ORDERING INFORMATION

Height Overall Inches	O.D. Base Inches	Fig. 1297 Standard Pkg. - 4 Pcs.	Fig. 1298 Standard Pkg. - 2 Pcs.	Screw Size	Weight Ounces
1-3/4	1-5/8	1297 000 CHR	1298 000 CHR	6	2-3/4

### FIG. 380 & 380A - GRAB RAIL POSTS

**CHROME PLATED BRONZE**

**FIG. 380 - END POST**  
**FIG. 380A - CENTER POST**



**FIG. 380**  
**END POST**



**FIG. 380A**  
**CENTER POST**

Hollow, For 1 Inch O.D. Tubing

#### ORDERING INFORMATION

Height Overall Inches	O.D. Base Inches	Fig. 380 Standard Pkg. - 1 Pc.	Fig. 380A Standard Pkg. - 1 Pc.	Screw Size	Weight Ounces
3-3/8	2-1/2	380 000 CHR	380 A00 CHR	8	10

### FIG. 413 & 413A - GRAB RAIL POSTS

**CHROME PLATED BRONZE**

**FIG. 413 - END POST**  
**FIG. 413A - CENTER POST**



**FIG. 413**  
**END POST**



**FIG. 413A**  
**CENTER POST**

Hollow, For 1 Inch O.D. Tubing with .035 Inch Wall Thickness

#### ORDERING INFORMATION

Height Overall Inches	Dimensions Base Inches	Standard Pkg. - 1 Pc.	Screw Size	Weight Ounces
2-1/4	3 x 2	413 000 CHR	8	10
2-1/4	2-3/4 x 1-1/2	413 A00 CHR	8	7-1/4



## AXE BRACKETS, WOOD GUARD RAIL FITTINGS & RING BUOY HOLDER

**FIG. 325 - AXE BRACKETS**



**STAINLESS STEEL**



**Fig. 325**

**ORDERING INFORMATION**

For Blade Width Inches	Standard Pkg. - 10 sets	Socket Screw Size	Bracket Screw Size	Weight per Set Ounces
6	325 000 STS	10 R.H.	6	4-1/2

**FIG. 180 & 185 - FITTINGS FOR WOOD GUARD RAILS**

**CHROME PLATED BRONZE**

**HINGE - FIG. 180**

**LATCH - FIG. 185**



**Fig. 180**

**ORDERING INFORMATION**

For Rail Dimensions Inches	Length Overall Inches	Fig. 180 Standard Pkg. - 1 Pc.	Fig. 185 Standard Pkg. - 1 Pc.	Screw Size	Weight Pounds
2-3/8 x 1-3/8	5	180 001 CHR	185 001 CHR	8	3/4
2-7/8 x 1-1/4	5-1/2	180 002 CHR	185 002 CHR	8	1



**Fig. 185**

**FIG. 1017 - RING BUOY HOLDER**



**BRASS  
PLAIN OR CHROME PLATED**

**ORDERING INFORMATION**

Width Mounting Plate Inches	Height Overall Inches	Chrome Plated Brass Display Pkg. - 5 Cards 1 Pc. per Card	Plain Brass Standard Pkg. - 5 Pcs.	Screw Size	Weight Pounds
3	4-1/2	1017 DP CHR	1017 000 PLB	8	1/2



**Fig. 1017**



**FIG. 492 - BOAT HOOK HOLDERS**



**STAINLESS STEEL**

**FIG. 492**

**ORDERING INFORMATION**



Maximum Pole O.D. Inches	Length Inches	Width Inches	Display Pkg. - 10 Cards 1 Pair per Card	OEM Bulk Pkg. 50 Pair	Screw Size	Weight Per Pair Ounces
1-1/2	3-1/2	1	492 DP STS	492 000 STS	6	1-1/2



**FIG. 477 - POLE STORAGE CLIPS**



**FIG. 477**

**SOFT BLACK PLASTIC**

**ORDERING INFORMATION**



For Pole O.D. Inches	Display Pkg. - 10 Cards 1 Pair per Card	OEM Bulk Pkg. 50 Pair	Screw Size	Weight per Pair Ounces
3/4	477 DP BLK	477 000 BLK	10 P.H.	3



**FIG. 502 - SPRING CLAMPS**

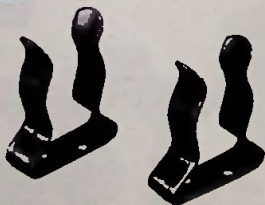

**STAINLESS STEEL**

**FIG. 502**

**ORDERING INFORMATION**



Minimum I.D. Inches	Maximum I.D. Inches	Projection Inches	Width Clamp Inches	Display Pkg. - 10 Cards 1 Pair per Card	Screw Size	Weight per Pair Ounces
5/8	1-1/4	1-1/2	1/2	502 DP1 STS	6 R.H.	2
1	1-3/4	2-1/4	5/8	502 DP2 STS	6 R.H.	2-1/2



**ROPE PULLEYS**

**FIG. 1255 - ROPE PULLEY**



**CHROME PLATED ZINC  
WHITE PLASTIC SHEAVE**

Coaming Type  
Maximum Rope Size 1/4 Inch.

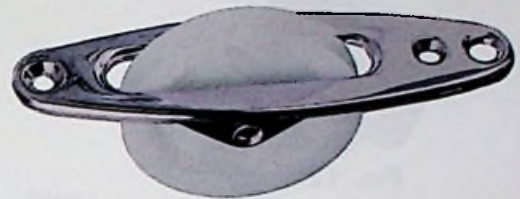

**FIG. 1255**

**ORDERING INFORMATION**

O.D. Sheave Inches	Dimensions Plate Inches	Display Pkg. - 10 Cards 1 Pc. per Card	Screw Size	Weight Ounces
2-5/16	4-7/8 x 1-1/4	1255 DP CHR	6	1/2



**FIG. 565 - ROPE PULLEY**



**STAINLESS STEEL  
WHITE PLASTIC SHEAVE**

Swivel Type with Strap  
Maximum Rope Size 1/4 Inch.



**FIG. 565**

**ORDERING INFORMATION**

O.D. Sheave Inches	Length Overall Inches	Length Strap Inches	Display Pkg. - 5 Cards 2 Pcs. per Card	Screw Size	Weight Ounces
2-5/16	3-3/4	1-5/8	565 DP	10 R.H.	2



**FIG. 634 - ROPE PULLEY**



**STAINLESS STEEL  
WHITE PLASTIC SHEAVE**

Swivel Snap Hook Type  
Maximum Rope Size 1/4 Inch.



**FIG. 634**

**ORDERING INFORMATION**

O.D. Sheave Inches	Length Overall Inches	Opening Snap Throat Inches	Display Pkg. - 5 Cards 2 Pcs. per Card	Weight Ounces
2-5/16	4-5/8	1/2	634 DP	2-1/2





**Fig. 1226**

**FIG. 1226 - ROPE CLAMP**

**CHROME PLATED ZINC**

For 1/8 or 3/16 Inch Rope.

**ORDERING INFORMATION**



Length Overall Inches	Width Inches	Display Pkg. - 25 Cards 2 Pcs. per Card	Weight Ounces
1-1/4	11/16	1226 DP CHR	1



**Fig. 1256**



**Fig. 1261**

**FIG. 1256 & 1261 - ROPE GUIDES**

**CHROME PLATED ZINC**

**ORDERING INFORMATION**



I.D. Hole Inches	Dimensions Base Inches	Display Pkg. - 25 Cards 2 Pcs. per Card	OEM Bulk Pkg. 100 Pcs.	Screw Size	Weight Ounces
5/16	1-1/4 x 3/4	1256 DP CHR	1256 000 CHR	6	1/2
5/16	1-1/4 x 3/4	1261 DP CHR	1261 000 CHR	6	1/2



**Fig. 533**

**FIG. 533 - HAND WINDSHIELD WIPER**

**CHROME PLATED ZINC**

**400 SERIES STAINLESS STEEL ARM AND BLADE HOLDER**

For Straight and Curved Windshields,  
the Arm is Extendable from 6-3/4 to 10-1/2 Inches  
(Length Overall is 8 to 11-1/2 Inches), and the Spring Tension is Adjustable.

**ORDERING INFORMATION**

O.D. Shaft Inches	Maximum Thickness of Panel Inches	Length Handle Inches	Length Blade Inches	Display Pkg. - 5 Pcs. 1 Pc. per Card	Weight Ounces
3/8	1-1/8	2-3/8	12	533 DP STS	8

Spare Arm, Cat. No. 533 000 99A.  
Spare Curved Blade, Cat. No. 533 000 99B.  
Spare Handle, Cat. No. 533 000 99D.



## ROPE GUIDE & TIGHTENERS

**FIG. 1243 - ROPE GUIDE**



**CHROME PLATED ZINC  
WITH PLASTIC SHEAVE**



**FIG. 1243**

**ORDERING INFORMATION**

Maximum Rope Size Inches	O.D. Sheave Inches	Dimensions Base Inches	Display Pkg. - 10 Cards 1 Pc. per Card	Screw Size	Weight Ounces
1/4	7/8	2 x 3/4	1243 DP CHR	8	1-3/4



**FIG. 732 - ROPE TIGHTENER**



**ZINC PLATED SPRING STEEL  
OR  
STAINLESS STEEL**



**FIG. 732 STAINLESS**

**ORDERING INFORMATION**

Finish	Length Normal Inches	Length Compressed Inches	O.D. Inches	Display Pkg. - 5 Cards 2 Pcs. per Card	Weight Ounces
Zinc	4	5	1	732 DP CAD	3-1/2
Stainless	4	5	1	732 DP STS	2-1/4



**FIG. 732 ZINC**



**FIG. 754 - ROPE TIGHTENER**



**ZINC PLATED SPRING STEEL**

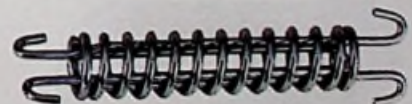

**FIG. 754**

**ORDERING INFORMATION**

Length Normal Inches	Length Compressed Inches	O.D. Inches	Display Pkg. - 10 Cards 2 Pcs. per Card	Weight Ounces
4-3/4	6-1/2	7/8	754 DP CAD	2-3/4



## EYE STRAPS



**FIG. 881 - EYE STRAP**



**FIG. 881**

**CHROME PLATED FORGED BRONZE**

**ORDERING INFORMATION**

Length Overall Inches	I.D. Eye Inches	O.D. Stock at Eye Inches	Display Pkg. - 25 Cards 2 Pcs. per Card	Screw Size	Weight Ounces
1-7/8	1/4	1/4	881 DP0 CHR	8	1/2
2-1/4	5/16	9/32	881 DP1 CHR	10	3/4
2-3/4	1/2	5/16	*881 DP2 CHR	10	1-1/2



\* Display Pkg. - 10 cards, 2 Pcs. per card.



**FIG. 1242 - EYE STRAP**



**FIG. 1242**

**CHROME PLATED ZINC**

**ORDERING INFORMATION**

Length Overall Inches	I.D. Eye Inches	Display Pkg. - 10 Cards 5 Pcs. per Card	OEM Bulk Pkg. 100 Pcs.	Screw Size	Weight Ounces
1-7/8	5/16	1242 DP CHR	1242 000 CHR	8	1/4



**FIG. 562 - EYE STRAP**



**FIG. 562**

**300 SERIES STAINLESS STEEL**

**ORDERING INFORMATION**

Length Overall Inches	I.D. Eye Inches	Display Pkg. - 10 Cards 5 Pcs. per Card	OEM Bulk Pkg. 100 Pcs.	Screw Size	Weight Ounces
1-5/8	1/4	562 DP STS	562 000 STS	10 R.H.	1/8





## FENDER LOCK & HOOKS

**FIG. 1299 - FENDER LOCK**



**CHROME PLATED ZINC**

The Eye is to be Permanently Attached to the Fender Line.

**ORDERING INFORMATION**

I.D. Eye Inches	O.D. Flange Inches	Display Pkg. - 10 Cards 2 Pcs. per Card	Screw Size	Weight Ounces
3/8	1-1/2	1299 DP CHR	8	1

Spare Eye, Cat. No. 1299 000 99A.



**FIG. 1299**



**FIG. 1246 - FENDER HOOK**



**CHROME PLATED ZINC**

**ORDERING INFORMATION**

Maximum Rope Size Inches	Dimensions Plate Inches	Display Pkg. - 10 Cards 2 Pcs. per Card	Screw Size	Weight Ounces
3/8	1-3/4 x 1-1/4	1246 DP CHR	6	1-1/4



**FIG. 1246**



**FIG. 1309 - SNAP TYPE FENDER HOOK**



**CHROME PLATED ZINC**

**ORDERING INFORMATION**

Maximum Rope Size Inches	Dimensions Plate Inches	Display Pkg. - 10 Cards 2 Pcs. per Card	OEM Bulk Pkg. 100 Pcs.	Screw Size	Weight Ounces
1/4	1-9/16 x 1-3/8	1309 DP CHR	1309 000 CHR	6	1-1/2



**FIG. 1309**



**FIG. 614 - FAST EYE SNAP HOOK**

**NON-MAGNETIC 316 SERIES STAINLESS STEEL**

**INTERLOCKING TONGUE**

**ORDERING INFORMATION**

I.D. Eye Inches	Length Overall Inches	O.D. Stock Inches	Display Pkg. - 10 Cards 1 Pc. per Card	Weight Ounces	Safe Working Load Pounds
3/8	3	5/16	614 DP STS	2-1/2	350



**FIG. 614**



## EYE SNAPS

**NOTE: THE SNAPS ILLUSTRATED BELOW SHOULD NOT BE USED FOR LIFTING, WINCHING, TOWING, MOORING OR LIKE APPLICATIONS.**

### FIG. 612 - FAST EYE BOAT SNAP



**FIG. 612**

**PLAIN BRONZE**

#### ORDERING INFORMATION

I.D. Eye Inches	Length Overall Inches	Display Pkg. - 10 Cards 1 Pc. per Card	Weight Ounces
3/8	2-1/16	612 DP0 PLB	1
5/8	2-7/8	612 DP1 PLB	1-1/2
3/4	3	612 DP2 PLB	2
3/4	3-7/8	612 DP3 PLB	4



### FIG. 613 - SWIVEL EYE BOAT SNAP



**FIG. 613**

**PLAIN BRONZE**

#### ORDERING INFORMATION

I.D. Eye Inches	Length Overall Inches	Display Pkg. - 10 Cards 1 Pc. per Card	Weight Ounces
9/16	3-1/4	613 DP1 PLB	2
11/16	3-5/8	613 DP2 PLB	3
3/4	4-5/8	613 DP3 PLB	4



### FIG. 659 - SWIVEL EYE SNAP



**FIG. 659**

**PLAIN BRONZE**

#### ORDERING INFORMATION

I.D. Eye Inches	I.D. Hook Inches	Length Overall Inches	Display Pkg. - 10 Cards 1 Pc. per Card	Weight Ounces
3/4	7/16	3-1/2	659 DP PLB	2-1/2



### FIG. 1289 - SWIVEL EYE SNAP



**FIG. 1289**

**CHROME PLATED ZINC**

**INTERLOCKING TONGUE**

#### ORDERING INFORMATION

I.D. Eye Inches	Length Overall Inches	Display Pkg. - 10 Cards 1 Pc. per Card	Weight Ounces
5/8	3	1289 DP CHR	2-1/2





## BABY EYE SNAPS

**NOTE: THE SNAPS ILLUSTRATED BELOW SHOULD NOT BE USED FOR LIFTING, WINCHING, TOWING, MOORING OR LIKE APPLICATIONS.**

**FIG. 1041 - SWIVEL BABY EYE SNAP**



**PLAIN BRONZE**

**ORDERING INFORMATION**

Dimensions Eye Inches	Length Overall Inches	Display Pkg. - 10 Cards 1 Pc. per Card	Weight Ounces
5/8 x 5/16	2-1/8	1041 DP PLB	1/2



**FIG. 1041**



**FIG. 1042 - SWIVEL BABY EYE SNAP**



**PLAIN BRONZE**

**ORDERING INFORMATION**

I.D. Eye Inches	Length Overall Inches	Display Pkg. - 10 Cards 1 Pc. per Card	Weight Ounces
3/8	2-1/8	1042 DP PLB	1/2



**FIG. 1042**



**FIG. 842 - FAST BABY EYE SNAP**



**PLAIN BRONZE**

**ORDERING INFORMATION**

I.D. Eye Inches	Length Overall Inches	Display Pkg. - 10 Cards 1 Pc. per Card	Weight Ounces
3/8	1-7/8	842 DP PLB	1/2



**FIG. 842**



## ROWLOCK HORNS



**FIG. 1227 - NORTH RIVER TYPE ROWLOCK HORNS**



**FIG. 1227**

**ZINC  
PLAIN OR CHROME PLATED**

**ORDERING INFORMATION**

Finish	O.D. Shank Inches	Length Shank Inches	Between Horns Inches	Display Pkg. - 10 Cards 1 Pair per Card	Weight per Pair Ounces
Plain	1/2	1-3/4	1-3/4	1227 DP ZNC	10
Chrome	1/2	1-3/4	1-3/4	1227 DP CHR	10



**FIG. 1267 - ROUND TYPE ROWLOCK HORNS**



**FIG. 1267**

**ZINC  
PLAIN OR CHROME PLATED**

**ORDERING INFORMATION**

Finish	O.D. Shank Inches	Length Shank Inches	I.D. Horn Inches	Display Pkg. - 10 Cards 1 Pair per Card	Weight per Pair Ounces
Plain	1/2	1-3/4	2	1267 DP ZNC	9-1/2
Chrome	1/2	1-3/4	2	1267 DP CHR	9-1/2



**FIG. 1262 - RIBBED TYPE ROWLOCK HORNS**



**FIG. 1262**

**ZINC  
PLAIN OR CHROME PLATED**

**ORDERING INFORMATION**

Finish	O.D. Shank Inches	Length Shank Inches	Between Horns Inches	Display Pkg. - 10 Cards 1 Pair per Card	Weight per Pair Ounces
Plain	1/2	1-3/4	1-3/4	1262 DP ZNC	8
Chrome	1/2	1-3/4	1-3/4	1262 DP CHR	8



## ROWLOCK SOCKETS, OAR LEATHERS & BUTTONS

**FIG. 1185 - TOP MOUNT ROWLOCK SOCKETS**



**ZINC**  
**PLAIN OR CHROME PLATED**  
**BLACK PLASTIC BEARINGS**

**ORDERING INFORMATION**

Finish	Length Inches	Width Inches	Depth Inches	Display Pkg. - 10 Cards 1 Pair per Card	OEM Bulk Pkg. 50 Pair	Weight per Pair Ounces
Plain	2-7/8	1-1/8	1-1/8	1185 DP ZNC	1185 000 ZNC	5
Chrome	2-7/8	1-1/8	1-1/8	1185 DP CHR	1185 000 CHR	5



**Fig. 1185**

Screw Size #10.  
 Spare Plastic Bearing, Cat. No. 1155 000 BLK.

**FIG. 1186 - EDGE MOUNT ROWLOCK SOCKETS**



**ZINC**  
**PLAIN OR CHROME PLATED**  
**BLACK PLASTIC BEARINGS**

**ORDERING INFORMATION**

Finish	Length Inches	Width Inches	Depth Inches	Display Pkg. - 10 Cards 1 Pair per Card	Weight per Pair Ounces
Plain	4	7/8	1-1/8	1186 DP ZNC	9
Chrome	4	7/8	1-1/8	1186 DP CHR	9



**Fig. 1186**

Screw Size #10.  
 Spare Plastic Bearing, Cat. No. 1155 000 BLK.

**FIG. 1187 - SIDE MOUNT ROWLOCK SOCKETS**



**ZINC**  
**PLAIN OR CHROME PLATED**  
**BLACK PLASTIC BEARINGS**

**ORDERING INFORMATION**

Finish	Length Inches	Depth Inches	Display Pkg. - 10 Cards 1 Pair per Card	Weight per Pair Ounces
Plain	4	1-1/4	1187 DP ZNC	6
Chrome	4	1-1/4	1187 DP CHR	6



**Fig. 1187**

Screw Size #10.  
 Spare Plastic Bearing, Cat. No. 1155 000 BLK.

**FIG. 233 - OAR LEATHERS & BUTTONS**

**LEATHER**

**ORDERING INFORMATION**

Dimensions Leather Inches	Dimensions Button Inches	Standard Pkg. - 5 Pair	Weight per Pair Ounces
7 x 6-1/2	1/2 x 13	233 001	10



**Fig. 233**

Note: Pair Consists of 2 Leathers and 2 Buttons.



## ROWLOCK HORNS



**Fig. 830**

**FIG. 830 - NORTH RIVER TYPE ROWLOCK HORNS**

**PLAIN MANGANESE BRONZE**

**ORDERING INFORMATION**

O.D. Shank Inches	Length Shank Inches	Between Horns Inches	Display Pkg. - 5 Cards 1 Pair per Card	Weight per Pair Ounces
1/2	2-1/8	2-1/8	830 DP PLB	13



**Fig. 829**

**FIG. 829 - ROUND TYPE ROWLOCK HORNS**

**PLAIN MANGANESE BRONZE**

**ORDERING INFORMATION**

O.D. Shank Inches	Length Shank Inches	I.D. Horn Inches	Display Pkg. - 5 Cards 1 Pair per Card	Weight per Pair Ounces
1/2	2-1/8	2	829 DP0 PLB	14
1/2	2-1/8	2-1/4	829 DP1 PLB	16



**Fig. 828**

**FIG. 828 - RIBBED TYPE ROWLOCK HORNS**

**PLAIN MANGANESE BRONZE**

**ORDERING INFORMATION**

O.D. Shank Inches	Length Shank Inches	Between Horns Inches	Display Pkg. - 5 Cards 1 Pair per Card	Weight per Pair Ounces
1/2	2-1/8	2	828 DP PLB	13



**Fig. 831**

**FIGS. 831, 832 & 833 - ROWLOCK SOCKETS**

**PLAIN MANGANESE BRONZE**



**Fig. 832**

**ORDERING INFORMATION**



**Fig. 833**

Mount	Length Inches	Width Inches	Depth Inches	Display Pkg. - 5 Cards 1 Pair per Card	Weight per Pair Ounces
Top	2-3/8	7/8	1	831 DP PLB	4
Side	3-5/8	---	1-3/8	832 DP PLB	7
Edge	4	3/4	1-3/4	833 DP PLB	8

Screw Size #10.



## TABLE BRACKETS, LADDER LOCKS & SAIL MAKER'S PALM

**FIG. 148 - TABLE BRACKETS**

**CHROME PLATED BRASS**

For Removable Tables  
Supplied in Sets Consisting of Two Brackets and Two Wall Plates.

**ORDERING INFORMATION**

Dimensions Angle Bracket Inches	Dimensions Wall Plate Inches	Display Pkg. - 5 Cards 1 Set per Card	OEM Bulk Pkg. 25 Sets	Screw Size	Weight per Set Ounces
2-3/4 x 1-11/16	3-3/8 x 2	148 DP CHR	148 000 CHR	10	12

Spare Pair of Angle Brackets, Cat. No. 148 000 99A. Spare Pair of Wall Plates, Cat. No. 148 000 99B.



**FIG. 148**

**FIG. 669 - LADDER LOCKS**

**CHROME PLATED BRONZE**

**ORDERING INFORMATION**

Height Overall Inches	Length Socket Inches	Length Bracket Inches	Std. Pkg. - 5 Sets OEM Pkg. - 25 Sets	Screw Size	Weight per Set Ounces
1-1/4	1	1-3/4	669 000 CHR	8	12

Spare Pair of Sockets, Cat. No. 669 000 99A.



**FIG. 669**

**FIG. 411 - SAIL MAKER'S PALM**

**LEATHER  
RIGHT HAND**

**ORDERING INFORMATION**

Display Pkg. - 5 Cards 1 Pc. per Card	Weight Ounces
411 DP	2



**FIG. 411**



## WINDSHIELD ADJUSTERS

**FIG. 359 - WINDSHIELD ADJUSTERS**



**Fig. 359**

**BLACK ANODIZED ALUMINUM SLIDE ON BLACK PLASTIC TRACK.  
CHROME PLATED BRASS ARM.  
BLACK PLASTIC KNOB AND END FITTINGS.**

**ORDERING INFORMATION**

Length Overall Inches	Length Adjustment Inches	Standard Pkg. - 1 Each	Screw Size	Weight Pounds
9	4-3/4	359 001 BLK	8	1/2
14	9-3/8	359 002 BLK	8	3/4
19	14-5/8	359 003 BLK	8	1



**FIG. 1290 & 1291 - WINDSHIELD ADJUSTERS**



**FIG. 1290  
SIDE MOUNT**

**FIG. 1291  
OFFSET MOUNT**

**CHROME PLATED ZINC  
BLACK PLASTIC KNOB**

**FIG. 1290 - SIDE MOUNT  
FIG. 1291 - OFFSET MOUNT**

**ORDERING INFORMATION**

Length Overall Inches	Length Adjustment Inches	Display Pkg. - 5 Cards 1 Pair per Card	OEM Bulk Pkg. 10 Pair	Screw Size	Weight per Pair Pounds
12	9-1/2	1290 DP CHR	1290 000 CHR	8	1-1/2
12	9-1/2	1291 DP CHR	1291 000 CHR	8	1-1/2

**SPARE PARTS ORDERING INFORMATION**

Figure No.	Port Adjuster	Starboard Adjuster	Mounting Bracket With Knob	Knob Only
1290	1290 P00 99A	1290 S00 99A	1290 000 99B	1292 000 BLK
1291	1291 P00 99A	1291 S00 99A	1291 000 99B	1292 000 BLK

NOTE: Illustration is Port Side.

**FIG. 82 - WINDSHIELD ADJUSTER**

**CHROME PLATED BRASS AND BRONZE  
BLACK PLASTIC KNOB**



**Fig. 82**

**ORDERING INFORMATION**

Length Overall Inches	Length Adjustment Inches	Standard Pkg. - 1 Pair	Screw Size	Weight per Pair Pounds
12	9-1/2	82 000 CHR	8	2-3/8

Spare Port Adjuster, Cat. No. 82 P00 99B.  
Spare Starboard Adjuster, Cat. No. 82 S00 99B.  
Spare Knob, Cat. No. 82 000 99A.

NOTE: Illustration is Port Side.



## WINDSHIELD ADJUSTERS



**FIG. 1179 - WINDSHIELD ADJUSTER**

**CHROME PLATED BRASS AND ZINC  
BLACK PLASTIC KNOB**

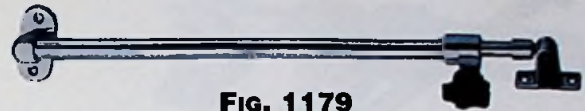

**FIG. 1179**

**ORDERING INFORMATION**

Length Closed Inches	Length Open Inches	O.D. Tube Inches	Display Pkg. - 5 Cards 1 Pc. per Card	OEM Bulk Pkg. 20 Pcs.	Screw Size	Weight Ounces
10	18	1/2	1179 DP1 CHR	1179 001 CHR	6	9
12	20	1/2	1179 DP2 CHR	1179 002 CHR	6	11

Spare Knob, Cat. No. 1117 DP BLK.



**FIG. 1180 - WINDSHIELD ADJUSTER**

**CHROME PLATED BRASS AND ZINC  
BLACK PLASTIC KNOB**

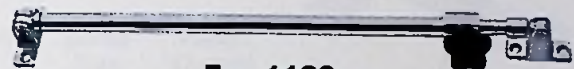

**FIG. 1180**

**ORDERING INFORMATION**

Length Closed Inches	Length Open Inches	O.D. Tube Inches	Display Pkg. - 5 Cards 1 Pc. per Card	OEM Bulk Pkg. 20 Pcs.	Screw Size	Weight Ounces
12	21	1/2	1180 DP CHR	1180 000 CHR	6	10

Spare Knob, Cat. No. 1117 DP BLK.



**FIG. 1116 - WINDSHIELD ADJUSTER**

**CHROME PLATED BRASS AND ZINC  
BLACK PLASTIC KNOB**

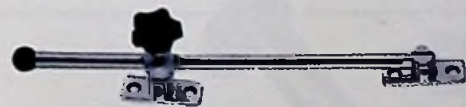

**FIG. 1116**

**ORDERING INFORMATION**

Length Rod Inches	O.D. Rod Inches	Display Pkg. - 5 Cards 1 Pc. per Card	OEM Bulk Pkg. 20 Pcs.	Screw Size	Weight Ounces
8	3/8	1116 DP1 CHR	1116 001 CHR	8	8
10	3/8	1116 DP2 CHR	1116 002 CHR	8	10
12	3/8	1116 DP3 CHR	1116 003 CHR	8	12

Spare Knob, Cat. No. 1117 DP BLK.

## HATCH ADJUSTER, BRACES & FASTENER

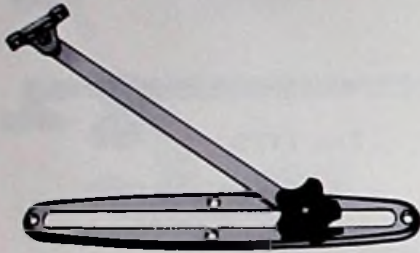

**Fig. 797**

**FIG. 797 - HATCH ADJUSTER**

**CHROME PLATED BRASS AND ZINC  
BLACK PLASTIC KNOB**

**ORDERING INFORMATION**

Length Arm Inches	Length Adjustment Inches	Length Slide Inches	Display Pkg. - 5 Cards 1 Pc. per Card	Screw Size	Weight Ounces
10	9-1/2	10-3/4	797 DP CHR	8	13



**Fig. 762**

**FIG. 762 - HATCH SUPPORT BRACES**

**CHROME PLATED BRASS**

**ORDERING INFORMATION**

Length Open Inches	Display Pkg. - 5 Cards 1 Pair per Card	OEM Bulk Pkg. 20 Pair	Screw Size	Weight per Pair Ounces
10	762 DP1 CHR	762 001 CHR	8	10
12	762 DP2 CHR	762 002 CHR	8	12
14	762 DP3 CHR	762 003 CHR	8	14

NOTE: Illustration is Port Side.



**Fig. 155**

**FIG. 155 - HATCH FASTENER OR WINDSHIELD KEEPER**

**CHROME PLATED BRASS AND ZINC  
PHOSPHOR BRONZE SPRING**

**ORDERING INFORMATION**

Length Overall Inches	Dimensions Mounting Base Inches	Display Pkg. - 5 Cards 1 Pc. per Card	OEM Bulk Pkg. 50 Pcs.	Screw Size	Weight Ounces
3-7/8	1-1/2 x 9/16	155 DP CHR	155 000 CHR	6	3-1/4



**HATCH FASTENERS OR WINDSHIELD KEEPERS**

**FIG. 769 - HATCH FASTENER OR WINDSHIELD KEEPER**



**CHROME PLATED BRASS AND ZINC  
BLACK PLASTIC KNOB**

**ORDERING INFORMATION**

Dimensions Base Inches	Display Pkg. - 5 Cards 1 Pc. per Card	OEM Bulk Pkg. 25 Pcs.	Screw Size	Weight Ounces
1-1/2 x 5/8	769 DP CHR	769 000 CHR	8	6



**Fig. 769**

Spare Keeper, Cat. No. 769 000 99A.  
Spare Handle with Stud, Cat. No. 769 000 99C.

**FIG. 697 - HATCH FASTENER OR WINDSHIELD KEEPER**



**CHROME PLATED BRASS AND ZINC**

**ORDERING INFORMATION**

Length Bolt Inches	Dimensions Bracket Inches	Dimensions Keeper Inches	Display Pkg. - 10 Cards 1 Pc. per Card	Screw Size	Weight Ounces
1-1/2	1-1/2 x 5/8	1-1/2 x 3/4	697 DP CHR	8	3



**Fig. 697**

**FIG. 967 - HATCH FASTENER OR WINDSHIELD KEEPER**



**CHROME PLATED BRONZE**

**ORDERING INFORMATION**

Length Bolt Inches	Dimensions Bracket Inches	Dimensions Keeper Inches	Display Pkg. - 5 Cards 1 Pc. per Card	Screw Size	Weight Ounces
1-1/2	1-9/16 x 1	1-7/8 x 7/8	967 DP CHR	8	6



**Fig. 967**

**FIG. 770 - HATCH FASTENER**



**CHROME PLATED BRONZE  
BLACK PLASTIC KNOB**

**ORDERING INFORMATION**

Dimensions Overall Inches	Adjustment Thread Inches	Display Pkg. - 5 Cards 1 Pc. per Card	OEM Bulk Pkg. 25 Pcs.	Screw Size	Weight Ounces
3-3/4 x 1-5/8	2-1/4	770 DP CHR	770 000 CHR	8	6



**Fig. 770**

## HOLD-DOWN CLAMPS



**FIG. 1112 - HOLD-DOWN CLAMP**



**FIG. 1112**

**CHROME PLATED BRONZE**

**Flat Mounting**

**ORDERING INFORMATION**

Length Inches	Width Inches	Display Pkg. - 5 Cards 1 Pc. per Card	OEM Bulk Pkg. 25 Pcs.	Screw Size	Weight Ounces
3	1-1/2	1112 DP CHR	1112 000 CHR	8	5-1/2



**FIG. 1113 - HOLD-DOWN CLAMP**



**FIG. 1113**

**CHROME PLATED BRONZE**

**Angle Mounting**

**ORDERING INFORMATION**

Length Inches	Width Inches	Display Pkg. - 5 Cards 1 Pc. per Card	OEM Bulk Pkg. 25 Pcs.	Screw Size	Weight Ounces
2-1/2	1-1/2	1113 DP CHR	1113 000 CHR	8	5-1/2



**FIG. 1108 - LOCKABLE HOLD-DOWN CLAMP**



**FIG. 1108**

**CHROME PLATED BRONZE**

**ORDERING INFORMATION**

Dimensions Base Inches	Clearance Padlock Inches	Display Pkg. - 5 Cards 1 Pc. per Card	OEM Bulk Pkg. 25 Pcs.	Screw Size	Weight Ounces
2-3/4 x 1-3/4	1/4	1108 DP CHR	1108 000 CHR	6	4



## PULL APART HINGES, HATCH TRIM & CONTINUOUS HINGE

### FIGS. 149 & 152 - PULL APART HINGES

**CHROME PLATED BRONZE**

**FIG. 149 - LEFT HAND**

**FIG. 152 - RIGHT HAND**



**FIG. 149  
LEFT HAND**

Use 2 Left Hand or 2 Right Hand For Quick Removal of Hatches, Motor Covers, etc. or Together (1 each Left & Right) as a Heavy Duty Hinge Set.

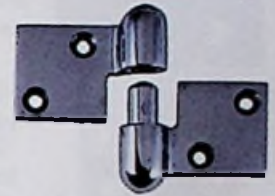

**FIG. 152  
RIGHT HAND**

### ORDERING INFORMATION

Length Open Inches	Width Overall Inches	Display Pkg. - 5 Cards		Screw Size	Weight Ounces
		1 Pc. per Card	OEM Pkg. - 25 Pcs.		
3-3/4	2	149 DP CHR	149 000 CHR	10	5-1/2
3-3/4	2	152 DP CHR	152 000 CHR	10	5-1/2

### FIG. 258 - HATCH TRIM

**POLISHED STAINLESS STEEL**

### ORDERING INFORMATION

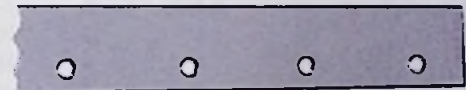

**FIG. 258**

Width Inches	Length Overall Inches	Standard Pkg. - 10 Pcs.	Screw Size	Weight Pounds
1-1/4	72	258 002 STS	6	1
1-1/2	72	258 004 STS	6	1-1/2



### FIG. 212 - CONTINUOUS HINGE

**POLISHED STAINLESS STEEL**

Countersunk holes are two inches apart, center to center.

### ORDERING INFORMATION

Width Open Inches	Length Overall Inches	Standard Pkg. - 10 Pcs.	Screw Size	Weight Pounds
1-1/4	72	212 002 STS	5	1-1/2
1-1/2	72	212 004 STS	5	2

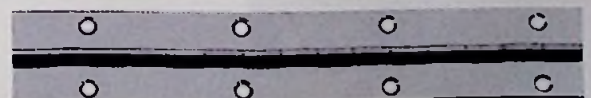

**FIG. 212**



## BUTT HINGES

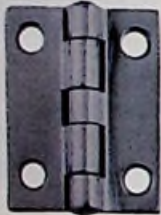

**FIG. 1002 - BUTT HINGE**

**HEAVY GAUGE EXTRUDED BRASS  
CHROME PLATED  
FAST PIN**



**ORDERING INFORMATION**



**Fig. 1002**

Height Pin Inches	Width Open Inches	Display Pkg. 1 Pair. per Card	Cards per Pkg.	Standard Pkg. Catalog No.	Std. Pkg. Pair	Screw Size	No. of Holes	Weight per Pair Pounds
1-1/2	1-1/2	-----	---	1002 002 CHR	5	6	4	1/4
2	1-1/2	1002 003 DP	5	1002 003 CHR	5	6	4	1/4
2	2	1002 004 DP	5	1002 004 CHR	5	6	6	3/8
2-1/2	2	-----	---	1002 005 CHR	1	8	6	1/2
2-1/2	2-1/2	-----	---	1002 006 CHR	1	8	6	5/8
3	2	1002 007 DP	5	1002 007 CHR	1	8	6	5/8
3	2-1/2	-----	---	1002 008 CHR	1	8	6	3/4
3	3	1002 009 DP	1	-----	---	10	6	1-1/4
3-1/2	2-1/2	-----	---	1002 010 CHR	1	10	6	7/8
3-1/2	3	-----	---	1002 011 CHR	1	10	6	1-1/4
4	3	1002 012 DP	1	-----	---	10	6	1-1/2
4	4	1002 013 DP	1	-----	---	1/4	6	1-3/4
5	4	-----	---	1002 014 CHR	1	1/4	8	2-1/4



**FIG. 1004 - BUTT HINGE**

**CHROME PLATED EXTRUDED BRASS  
EXTRA HEAVY DUTY, PLASTIC BEARINGS  
REMOVABLE PIN**

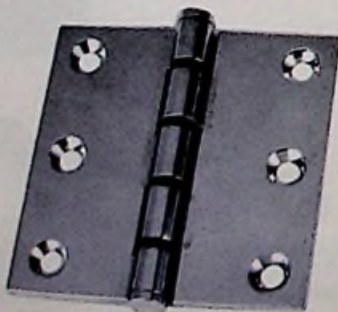

**Fig. 1004**

**For Transom Doors and Other Applications  
Where Extra Strength is Required.**

**ORDERING INFORMATION**

Height Pin Inches	Width Open Inches	Display Pkg. - 1 Card 1 Pair per Card	Screw Size	No. of Holes	Weight per Pair Pounds
4	4	1004 DP CHR	1/4	6	1-1/2



## BUTT HINGES

**FIG. 1293 - BUTT HINGE**

**CHROME PLATED ZINC  
REMOVABLE PIN**

**ORDERING INFORMATION**

Height Pin Inches	Width Open Inches	Display Pkg. - 5 Cards 1 Pair per Card	OEM Bulk Pkg. 25 Pair	Screw Size	No. of Holes	Weight per Pair Ounces
1-1/2	1-1/2	1293 DP2 CHR	-----	8	4	2
2	1-1/2	1293 DP3 CHR	-----	8	4	2-1/2
2	2	1293 DP4 CHR	*1293 004 CHR	8	4	3
2-1/2	2	1293 DP5 CHR	1293 005 CHR	8	6	4-1/2
2-1/2	2-1/2	1293 DP6 CHR	1293 006 CHR	8	6	5
3	3	1293 DP9 CHR	1293 009 CHR	10	6	7-1/2

\* OEM Bulk Pkg. - 50 Pair.

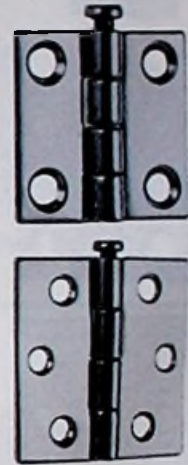

**FIG. 1293**

**FIG. 949 - BUTT HINGE**

**HEAVY GAUGE STAMPED BRASS  
CHROME PLATED  
FAST PIN**

**ORDERING INFORMATION**

Height Pin Inches	Width Open Inches	Chrome Plated Brass Display Pkg. - 5 Cards 1 Pair per Card	Chrome Plated Brass OEM Bulk Pkg. 25 Pair	Screw Size	No. of Holes	Weight per Pair Ounces
1-1/2	1-1/4	949 DP1 CHR	-----	6	4	2
1-1/2	1-1/2	949 DP2 CHR	-----	6	4	2-1/2
2	1-1/2	949 DP3 CHR	-----	6	4	2-3/4
2	2	949 DP4 CHR	949 004 CHR	6	6	4
2-1/2	2	949 DP5 CHR	949 005 CHR	8	6	5
2-1/2	2-1/2	949 DP6 CHR	949 006 CHR	8	6	6-3/4
3	3	949 DP9 CHR	949 009 CHR	10	6	9-1/2

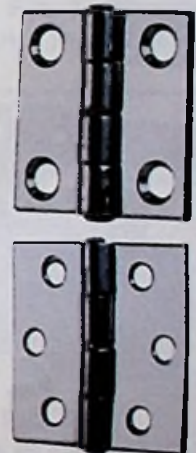

**FIG. 949**

**FIG. 941 - BUTT HINGE**

**CHROME PLATED ZINC**

**ORDERING INFORMATION**

Height Pin Inches	Width Open Inches	Display Pkg. - 5 Cards 1 Pair per Card	OEM Bulk Pkg. 50 Pair	Screw Size	Weight per Pair Ounces
1-1/2	1-1/2	941 DP CHR	941 000 CHR	8	2-1/2



**FIG. 941**

## HINGES

**FIG. 952 - BUTT HINGE**



**Fig. 952**

**HEAVY GAUGE STAMPED BRASS  
CHROME PLATED  
REMOVABLE PIN**

**ORDERING INFORMATION**

Height Pin Inches	Width Open Inches	Chrome Plated Brass Display Pkg. - 5 Cards 1 Pair per Card	Chrome Plated Brass OEM Bulk Pkg. 25 Pair	Screw Size	No. of Holes	Weight per Pair Ounces
1-1/2	1-1/4	952 DP1 CHR	-----	6	4	2
1-1/2	1-1/2	952 DP2 CHR	-----	6	4	2-1/2
2	1-1/2	952 DP3 CHR	-----	6	4	2-3/4
2	2	952 DP4 CHR	952 004 CHR	6	6	4
2-1/2	2	952 DP5 CHR	952 005 CHR	8	6	5
2-1/2	2-1/2	952 DP6 CHR	-----	8	6	6-3/4
3	3	952 DP9 CHR	952 009 CHR	10	6	9-1/2



**FIG. 773 - HINGE**



**Fig. 773**

**CHROME PLATED BRONZE  
REMOVABLE PIN**

**ORDERING INFORMATION**

Length Overall Inches	Width Overall Inches	Display Pkg. - 2 Cards 1 Pair per Card	Screw Size	Weight per Pair Pounds
3-1/8	2-5/8	773 DP CHR	10	1-5/8



**FIG. 951 - HINGE**



**Fig. 951**

**CHROME PLATED BRONZE**

**ORDERING INFORMATION**

Width Open Inches	Height Pin Inches	Display Pkg. - 5 Cards 1 Pair per Card	OEM Bulk Pkg. 25 Pair	Screw Size	Weight per Pair Ounces
3	1-1/2	951 DP1 CHR	951 001 CHR	8	3-1/2
4	1-1/2	951 DP2 CHR	951 002 CHR	8	5-1/2



## HINGES

### FIG. 808 - HINGE

**CHROME PLATED ZINC**

#### ORDERING INFORMATION

Width Open Inches	Height Pin Inches	Display Pkg. - 10 Cards 1 Pair per Card	OEM Bulk Pkg. 50 Pair	Screw Size	Weight per Pair Ounces
3	1-1/2	808 DP CHR	808 000 CHR	8	3-1/2



**Fig. 808**

### FIGS. 987 & 1213 - SHORTSIDE HINGES

**FIG. 987 - CHROME PLATED BRONZE**

**FIG. 1213 - CHROME PLATED ZINC**

#### ORDERING INFORMATION

Width Open Inches	Height Pin Inches	Width Shortside Inches	Display Pkg. - 5 Cards 1 Pair per Card	OEM Bulk Pkg. 50 Pair	Screw Size	Weight per Pair Ounces
2-1/4	1-1/2	3/4	987 DP1 CHR	987 001 CHR	8	3-1/2
2-3/4	1-1/2	3/4	987 DP2 CHR	-----	8	4
2-1/2	1-1/2	3/4	1213 DP1 CHR	1213 001 CHR	8	3



**Fig. 987  
CHROME PLATED BRONZE**  
**Fig. 1213  
CHROME PLATED ZINC**

### FIGS. 988 & 1214 - OFFSET SHORTSIDE HINGES

**FIG. 988 - CHROME PLATED BRONZE**

**FIG. 1214 - CHROME PLATED ZINC**

#### ORDERING INFORMATION

Width Open Inches	Height Pin Inches	Width Shortside Inches	Offset Inches	Display Pkg. - 5 Cards 1 Pair per Card	Screw Size	Weight per Pair Ounces
2-1/4	1-1/2	3/4	3/8	988 DP1 CHR	8	4
2-3/4	1-1/2	3/4	3/8	988 DP2 CHR	8	5
2-1/2	1-1/2	3/4	3/8	1214 DP1 CHR	8	4



**Fig. 988  
CHROME PLATED BRONZE**  
**Fig. 1214  
CHROME PLATED ZINC**

### FIG. 999 - SHORTSIDE HINGE

**CHROME PLATED BRONZE**

#### ORDERING INFORMATION

Width Open Inches	Height Pin Inches	Width Shortside Inches	Display Pkg. - 5 Cards 1 Pair per Card	Screw Size	Weight per Pair Ounces
3-1/2	1-1/2	1-1/2	999 DP CHR	8	5



**Fig. 999**



**FIG. 942 - OFFSET HINGE**



**Fig. 942**

Width Open Inches	Height Pin Inches	Offset Inches	Display Pkg. - 5 Cards 1 Pair per Card	OEM Bulk Pkg. 50 Pair	Screw Size	Weight per Pair Ounces
1-1/2	1-1/2	3/8	942 DP CHR	942 000 CHR	8	2-1/2

**CHROME PLATED ZINC**

**ORDERING INFORMATION**



**FIG. 271 - INSET HINGE**

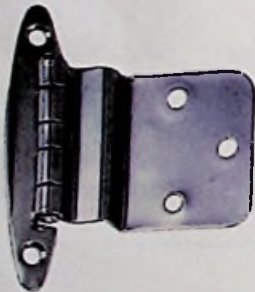

**Fig. 271**

Dimensions Inches	Display Pkg. - 10 Cards 1 Pair per Card	OEM Bulk Pkg. 100 Pair	Screw Size	Weight per Pair Ounces
2-3/4 x 2-1/8	271 DP CHR	271 000 CHR	4	2-1/2

**SEMI-CONCEALED  
FOR INSET DOORS**

**CHROME PLATED  
STAMPED BRASS**

**3/8 INCH INSET**

**ORDERING INFORMATION**



**FIG. 272 - FLUSH HINGE**



**Fig. 272**

Dimensions Inches	Display Pkg. - 10 Cards 1 Pair per Card	OEM Bulk Pkg. 100 Pair	Screw Size	Weight per Pair Ounces
2-3/4 x 2-1/8	272 DP CHR	272 000 CHR	4	2-1/2

**SEMI-CONCEALED  
FOR OVERLAY DOORS**

**CHROME PLATED  
STAMPED BRASS**

**ORDERING INFORMATION**



## HINGES



**FIG. 120 - STRAP HINGE**

**CHROME PLATED BRONZE**



**FIG. 120**

**ORDERING INFORMATION**

Width Open Inches	Height Pin Inches	Display Pkg. - 5 Cards 1 Pair per Card	Screw Size	No. of Holes	Weight per Pair Ounces
4	1-1/8	120 DP1 CHR	10	4	6
6	1-1/8	120 DP2 CHR	10	6	8
8	1-1/8	120 DP3 CHR	12	6	16



**FIG. 122 - SHORTSIDE STRAP HINGE**

**CHROME PLATED BRONZE**



**FIG. 122**

**ORDERING INFORMATION**

Width Open Inches	Height Pin Inches	Length Shortside Inches	Display Pkg. - 5 Cards 1 Pair per Card	Screw Size	No. of Holes	Weight per Pair Ounces
4-7/8	1-1/8	2-1/16	122 DP CHR	10	5	7



**FIG. 197 - "T" HINGE**

**CHROME PLATED BRONZE**



**FIG. 197**

**ORDERING INFORMATION**

Width Open Inches	Height Overall Inches	Width "T" Side Inches	Display Pkg. - 5 Cards 1 Pair per Card	Screw Size	No. of Holes	Weight per Pair Ounces
4	2-1/8	1-5/16	197 DP1 CHR	10	6	8
6	3	1-1/2	197 DP2 CHR	10	7	16
8	3-7/8	2	197 DP3 CHR*	12	8	25

\* Display Pkg. - 2 Cards, 1 Pair per Card.



**FIG. 924 - HINGE**

**CHROME PLATED STAMPED BRASS**



**Fig. 924**

**ORDERING INFORMATION**

Width Open Inches	Height Pin Inches	Display Pkg. - 10 Cards 1 Pair per Card	Screw Size	Weight per Pair Ounces
3	1-1/2	924 DP CHR	6	2-1/2



**FIG. 957 - NON-MORTISED HINGE**

**STAMPED BRASS  
CHROME PLATED**

Easily Installs Without Mortising.

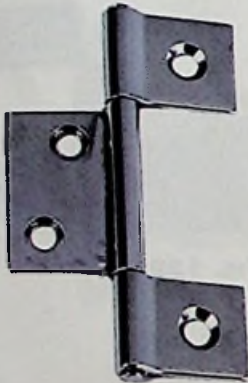

**Fig. 957**

**ORDERING INFORMATION**

Height Pin Inches	Width Closed Inches	Display Pkg. - 5 Cards 1 Pair per Card	OEM Bulk Pkg. 50 Pair	Screw Size	Weight per Pair Ounces
3-3/8	7/8	957 DP CHR	957 000 CHR	8	4



**FIG. 998 - HASP**

**CHROME PLATED BRONZE**

**ORDERING INFORMATION**



**Fig. 998**

Length Closed Inches	Width Overall Inches	Padlock Clearance Inches	Display Pkg. - 10 Cards 1 Pc. per Card	OEM Bulk Pkg. 25 Pcs.	Screw Size	Weight Ounces
2	1	9/32	998 DP1 CHR	998 001 CHR	6	2
3	1	9/32	998 DP2 CHR	998 002 CHR	6	3

Spare Chrome Keepers (2 per card), Cat. No. 959 DP CHR.



## HASPS & BARREL BOLT

**FIG. 1198 - HASP**

**CHROME PLATED ZINC**

**ORDERING INFORMATION**

Length Closed Inches	Width Inches	Padlock Clearance Inches	Display Pkg. - 10 Cards 1 Pc. per Card	OEM Bulk Pkg. 25 Pcs.	Screw Size	Weight Ounces
2	1	1/4	1198 DP1 CHR	1198 001 CHR	6	1-1/2
3	1	1/4	1198 DP2 CHR	1198 002 CHR	6	2-1/4
3-3/4	1	1/4	1198 DP3 CHR	1198 003 CHR	6	2-1/2

Spare Keepers (2 per card), Cat. No. 1261 DP CHR.



**FIG. 1198**

**FIG. 1194 - SWIVEL EYE HASP**

**CHROME PLATED ZINC**

Padlock Eye Swivels to Act as a Latch.

**ORDERING INFORMATION**

Length Closed Inches	Width Inches	Padlock Clearance Inches	Display Pkg. - 10 Cards 1 Pc. per Card	OEM Bulk Pkg. 50 Pcs.	Screw Size	Weight Ounces
3	1	11/32	1194 DP CHR	1194 000 CHR	6	2-1/2

Spare Keepers (2 per card), Cat. No. 1194 DP 99A.



**FIG. 1194**

**FIG. 947 - BARREL BOLT**

**CHROME PLATED BRONZE**

Supplied with Friction Pad to Eliminate Rattle and Provide Smooth Operation.

**ORDERING INFORMATION**

Dimensions Overall Inches	Chrome Plated Bronze Display Pkg. - 5 Cards 1 Pc. per Card	Chrome Plated Bronze OEM Bulk Pkg. 25 Pcs.	Screw Size	Weight Ounces
3-7/16 x 1-7/16	947 DP1 CHR	947 001 CHR	6	4
4-5/16 x 1-7/16	947 DP2 CHR	947 002 CHR	6	4-1/2
5-1/4 x 1-7/16	947 DP3 CHR	947 003 CHR	6	5

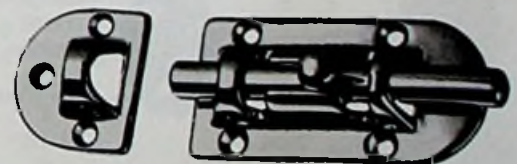

**FIG. 947**

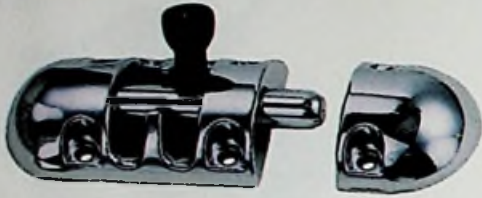

**Fig. 1244**

**FIG. 1244 - BARREL BOLT**

**CHROME PLATED ZINC**

Integral Friction Pad Eliminates Rattle and Provides Smooth Operation.

**ORDERING INFORMATION**

Dimensions Overall Inches	Display Pkg. - 5 Cards 1 Pc. per Card	OEM Bulk Pkg. 25 Pcs.	Screw Size	Weight Ounces
3-3/8 x 1-1/4	1244 DP CHR	1244 000 CHR	6 R.H.	3

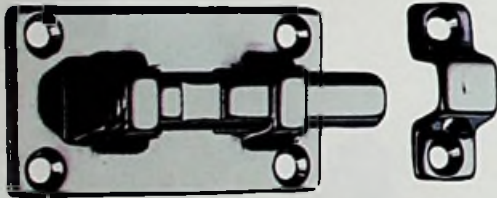

**Fig. 1053**

**FIG. 1053 - SHIP BOLT**

**CHROME PLATED BRONZE**

Supplied with Brass Friction Spring to Eliminate Rattle and Provide Detented Operation.

**ORDERING INFORMATION**

Dimensions Overall Inches	Display Pkg. - 5 Cards 1 Pc. per Card	OEM Bulk Pkg. 25 Pcs.	Screw Size	Weight Ounces
2-5/8 x 1-1/4	1053 DP CHR	1053 000 CHR	6	1-3/4



**Fig. 956**

**FIG. 956 - CABIN DOOR HOOK**

**CAST BRONZE**

**PLAIN OR CHROME PLATED**

**ORDERING INFORMATION**

Length Hook Inches	Chrome Plated Bronze Display Pkg. - 5 Cards 1 Pc. per Card	Chrome Plated Bronze OEM Bulk Pkg. 50 Pcs.	Plain Bronze Standard Pkg. - 5 Pcs.	Weight Ounces
1-1/2	956 DP1 CHR	956 001 CHR	956 001 PLB	1
2	956 DP2 CHR	956 002 CHR	956 002 PLB	1-1/2
2-1/2	956 DP3 CHR	956 003 CHR	956 003 PLB	1-3/4
3	956 DP4 CHR	956 004 CHR	956 004 PLB	2
3-1/2	956 DP5 CHR	-----	956 005 PLB	2-1/2
4	956 DP6 CHR	-----	956 006 PLB	3
5	956 DP7 CHR	-----	956 007 PLB	3-1/2
6	956 DP8 CHR	*956 008 CHR	956 008 PLB	5

\*O.E.M. Bulk Pkg. - 25 pcs.

Screw Size #6.

Spare Plain Keepers, (2 per card), Cat. No. 959 DP PLB.

Spare Chrome Keepers, (2 per card), Cat. No. 959 DP CHR.



## HOOKS, DOOR STOPS & HOLDER

**FIG. 1199 - CABIN DOOR HOOK**



**CHROME PLATED ZINC**

**ORDERING INFORMATION**

Length Hook Inches	Display Pkg. - 20 Cards 1 Pc. per Card	OEM Bulk Pkg. 50 Pcs.	Screw Size	Weight Ounces
1-3/4	1199 DP1 CHR	1199 001 CHR	6	1-1/4
2-1/4	1199 DP2 CHR	1199 002 CHR	6	1-3/8
3	1199 DP3 CHR	1199 003 CHR	6	1-1/2
4	1199 DP4 CHR	1199 004 CHR	6	1-3/4



**FIG. 1199**

Spare Keepers, (2 per card), Cat. No. 1261 DP CHR.

**FIG. 1287 - CABIN DOOR HOOK**



**CHROME PLATED ZINC**

**ORDERING INFORMATION**

Length Hook Inches	Display Pkg. - 20 Cards 1 Pc. per Card	OEM Bulk Pkg. 50 Pcs.	Screw Size	Weight Ounces
2	1287 DP1 CHR	1287 001 CHR	6	1-1/4
2-1/2	1287 DP2 CHR	1287 002 CHR	6	1-1/2
3	1287 DP3 CHR	1287 003 CHR	6	1-3/4



**FIG. 1287**

Spare Keepers, (2 per card), Cat. No. 1261 DP CHR.

**FIG. 574 - DOOR STOP AND HOLDER**



**CHROME PLATED BRONZE  
RUBBER BUMPER**

**ORDERING INFORMATION**

Length Inches	O.D. Inches	Display Pkg. - 5 Cards 1 Pc. per Card	OEM Bulk Pkg. 25 Pcs.	Stop Screw Size	Keeper Screw Size	Weight Ounces
2-3/8	1-3/4	574 DP1 CHR	574 001 CHR	8	6	4-1/2
3-1/4	1-3/4	574 DP2 CHR	574 002 CHR	8	6	5-1/2

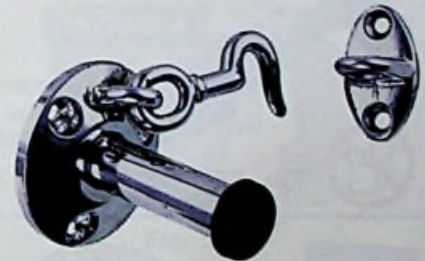

**FIG. 574**

**FIG. 1177 - DOOR STOP**



**CHROME PLATED ZINC  
RUBBER BUMPER**

**ORDERING INFORMATION**

Length Inches	O.D. Inches	Display Pkg. - 5 Cards 1 Pc. per Card	OEM Bulk Pkg. 50 Pcs.	Screw Size	Weight Ounces
1	1-1/4	1177 DP CHR	1177 000 CHR	4	1



**FIG. 1177**

## DOOR HOLDER, CATCH & BUTTONS



**FIG. 1065 - DOOR HOLDER**

**STAINLESS STEEL CLIP  
CHROME PLATED ZINC ARROW**



**FIG. 1065**

Dimensions Arrow Base Inches	Dimensions Clip Base Inches	Projection Inches	Display Pkg. - 5 Cards 1 Pc. per Card	Screw Size	Weight Ounces
1-5/8 x 3/4	1-3/8 x 7/16	1-3/4	1065 DP CHR	8	2

**ORDERING INFORMATION**



**FIG. 554 - DOOR CATCH**

**WHITE PLASTIC**

**STAINLESS STEEL SPRING  
CHROME PLATED BRASS SCREW**



**FIG. 554**

Screw Size Inches	Dimensions Catch Inches	Display Pkg. - 25 Cards 2 Pcs. per Card	OEM Bulk Pkg. 100 Pcs.	Mounting Screw Size	Weight per 50 Ounces
3/4 x #8	1-1/4 x 5/8	554 DP	554	4 R.H.	4

**ORDERING INFORMATION**



**FIG. 559 - DOOR CATCH**

**BLACK PLASTIC**

**ORDERING INFORMATION**



**FIG. 559**

Dimensions Stud Inches	Dimensions Catch Inches	Display Pkg. - 25 Cards 2 Pcs. per Card	OEM Bulk Pkg. 100 Pcs.	Screw Size	Weight per 50 Ounces
1-1/8 x 3/8	1-3/8 x 7/8	559 DP	559	4 R.H.	4



**FIGS. 1216 & 1217 - DOOR BUTTONS**

**CHROME PLATED ZINC  
BLACK PLASTIC BUTTON**



**FIG. 1216**

Fig. 1216 - Supplied with Phosphor Bronze Tension Spring.  
Fig. 1217 - Supplied without Spring and Requires a No. 8 Oval-Head Pivot Screw.



**FIG. 1217**

**ORDERING INFORMATION**

Type	O.D. Overall Inches	Display Pkg. - 10 Cards 1 Pc. per Card	OEM Bulk Pkg. 50 Pcs.	Screw Size	Weight Ounces
With Spring	1-3/4	1216 DP CHR	1216 000 CHR	6	1-1/2
w/o Spring	1-3/4	1217 DP CHR	1217 000 CHR	6	1-1/2

Spare Button for Both, Cat. No. 1216 000 99A.



**CUPBOARD BOLT, CATCH & TURNS**

**FIG. 1101 - CUPBOARD BOLT**

**CHROME PLATED ZINC  
BLACK PLASTIC SLIDE AND KNOB**

**ORDERING INFORMATION**

Dimensions Overall Inches	Display Pkg. - 5 Cards 1 Pc. per Card	OEM Bulk Pkg. 50 Pcs.	Screw Size	Weight Ounces
2-1/8 x 1-1/2	1101 DP CHR	1101 000 CHR	6	2



**FIG. 1101**

**FIG. 1102 - CUPBOARD CATCH**

**CHROME PLATED ZINC**

**No. 1 SUPPLIED WITH BOX STRIKE  
No. 2 SUPPLIED WITH 3/8 INCH OFFSET BOX STRIKE**

**ORDERING INFORMATION**

Strike Type	Dimensions Overall Inches	Display Pkg. - 5 Cards 1 Pc. per Card	OEM Bulk Pkg. 50 Pcs.	Screw Size	Weight Ounces
Box	1-1/2 x 1-7/8	1102 DP1 CHR	1102 001 CHR	6	3-1/2
Offset Box	1-1/2 x 1-7/8	1102 DP2 CHR	1102 002 CHR	6	3-1/2

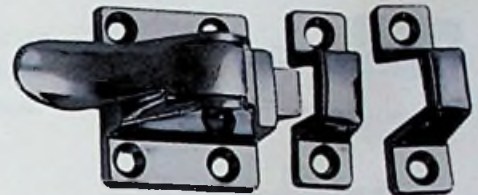

**FIG. 1102**

**FIG. 978 - CUPBOARD TURN**

**CHROME PLATED ZINC**

**ORDERING INFORMATION**

Dimensions Overall Inches	Display Pkg. - 5 Cards 1 Pc. per Card	Screw Size	Weight Ounces
2-1/8 x 2-1/4	978 DP CHR	6	5

Spare Strike Plate, Cat. No. 976 000 CHR.  
Spare Bevel with Cam, Cat. No. 984 000 CHR.

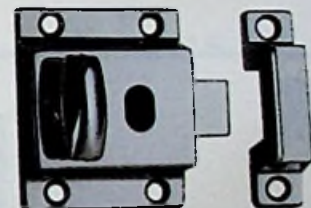

**FIG. 978**

**FIG. 986 - CUPBOARD TURN**

**CHROME PLATED ZINC**

**ORDERING INFORMATION**

Dimensions Overall Inches	Display Pkg. - 5 Cards 1 Pc. per Card	Screw Size	Weight Ounces
2 x 2-1/4	986 DP CHR	8	5

Spare Strike Plate, Cat. No. 977 000 CHR.  
Spare Bevel with Cam, Cat. No. 984 000 CHR.

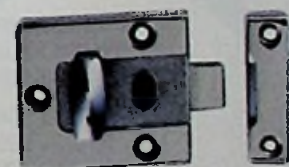

**FIG. 986**

## LATCHES & FLUSH LOCKS

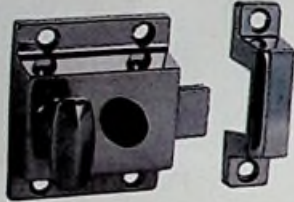

**FIG. 948**

**FIG. 948 - LATCH**

**CHROME PLATED ZINC**

**SLIDING LOCK BUTTON**

**ORDERING INFORMATION**

Dimensions Overall Inches	Display Pkg. - 5 Cards 1 Pc. per Card	Screw Size	Weight Ounces
2-1/8 x 2-1/4	948 DP CHR	6	5

Spare Strike Plate, Cat. No. 976 000 CHR.  
Spare Bevel with Cam, Cat. No. 984 000 CHR.

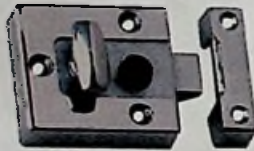

**FIG. 983**

**FIG. 983 - LATCH**

**CHROME PLATED ZINC**

**SLIDING LOCK BUTTON**

**ORDERING INFORMATION**

Dimensions Overall Inches	Display Pkg. - 5 Cards 1 Pc. per Card	Screw Size	Weight Ounces
2 x 2-1/4	983 DP CHR	8	5

Spare Strike Plate, Cat. No. 977 000 CHR.  
Spare Bevel with Cam, Cat. No. 984 000 CHR.



**FIG. 921**

**FIGS. 921 & 922 - FLUSH LOCK & LATCH**

**CHROME PLATED ZINC**

**FIG. 921 - LOCKING LATCH WITH 2 KEYS**

**FIG. 922 - NON-LOCKING LATCH**

Easily Installs in a 1-5/8 Inch Diameter Hole.  
For Door Thicknes 1/2 to 3/4 Inches.

**ORDERING INFORMATION**

Type	Dimensions Face Plate Inches	Display Pkg. - 5 Cards 1 Pc. per Card	OEM Bulk Pkg. 25 Pcs.	Weight Ounces
Lock	2-1/4 x 2	921 DP CHR	921 000 CHR	6-1/2
Latch	2-1/4 x 2	922 DP CHR	922 000 CHR	6

Spare Cam Bar, Cat. No. 980.



## FLUSH LOCKS & LATCHES



### FIGS. 931 & 932 - FLUSH LOCK & LATCH

**CHROME PLATED ZINC, BLACK OR WHITE PLASTIC,  
WITH STAINLESS STEEL STEM AND LOCK NUT.**

**FIG. 931 - LOCK WITH 2 KEYS**  
**FIG. 932 - LATCH (NON-LOCKING)**

**FLEXIBLE  
PLASTIC  
STRIKE**



No. 1 with Flush Cam Bar and Flexible Plastic Strike Plate.  
No. 2 with Offset Adjustable Cam Bar.  
No. 3 with Straight Cam Bar and Flexible Plastic Strike Plate.

Detents Indicate Open or Closed Position.  
Easily Installs in a 2 Inch Diameter Hole.  
For Door Thickness 1/4 to 1-1/8 Inches.



**FIG.**  
**931 #1 BLK**



**FIG.**  
**932 #2 BLK**



**FIG.**  
**931 #3 BLK**

### ORDERING INFORMATION

Finish	Type	Adjustment Latch Bar Inches	Dimensions Face Plate Inches	Display Pkg. - 5 Cards 1 Pc. per Card	OEM Bulk Pkg. 25 Pcs.	Weight Ounces
Black	Lock	3/8 to 3	2-1/2 x 2-1/2	931 DP1 BLK	931 001 BLK	8
Black	Lock	3/8 to 3	2-1/2 x 2-1/2	931 DP2 BLK	931 002 BLK	8-1/2
Black	Lock	1-1/16 to 2-9/16	2-1/2 x 2-1/2	931 DP3 BLK*	931 003 BLK*	6
Black	Latch	3/8 to 3	2-1/2 x 2-1/2	932 DP1 BLK	932 001 BLK	7
Black	Latch	3/8 to 3	2-1/2 x 2-1/2	932 DP2 BLK	932 002 BLK	7-1/2
Black	Latch	1-1/16 to 2-9/16	2-1/2 x 2-1/2	932 DP3 BLK*	932 003 BLK*	7
White	Lock	3/8 to 3	2-1/2 x 2-1/2	931 DP1 WHT	931 001 WHT	8
White	Lock	3/8 to 3	2-1/2 x 2-1/2	931 DP2 WHT	931 002 WHT	8-1/2
White	Lock	1-1/16 to 2-9/16	2-1/2 x 2-1/2	931 DP3 WHT*	931 003 WHT*	6
White	Latch	3/8 to 3	2-1/2 x 2-1/2	932 DP1 WHT	932 001 WHT	7
White	Latch	3/8 to 3	2-1/2 x 2-1/2	932 DP2 WHT	932 002 WHT	7-1/2
White	Latch	1-1/16 to 2-9/16	2-1/2 x 2-1/2	932 DP3 WHT*	932 003 WHT*	7

\* New Item

Spare Flush Cam Bar, Cat. No. 931 001 99A.

Spare Offset Adjustable Cam Bar, Cat. No. 931 002 99A.

Spare Straight Cam Bar, Cat. No. 931 003 99A.

## FLUSH LOCKS & LATCHES



**FIG.**  
**1011 #1 BLK**

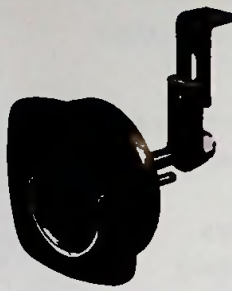

**FIG.**  
**1012 #2 BLK**

### FIGS. 1011 & 1012 - FLUSH LOCK & LATCH

**CHROME PLATED ZINC. BLACK PLASTIC, WITH STAINLESS STEEL STEM AND LOCK NUT.**

**FIG. 1011 - LOCK WITH 2 KEYS**

**FIG. 1012 - LATCH (NON-LOCKING)**

- No. 1 with Flush Cam Bar and Flexible Plastic Strike Plate.
- No. 2 with Offset Adjustable Cam Bar.
- No. 3 with Straight Cam Bar and Flexible Plastic Strike Plate.

Detents Indicate Open or Closed Position.  
Easily Installs in a 2-3/8 Inch Diameter Hole.  
For Door Thickness 3/8 to 1-1/4 Inches.



### ORDERING INFORMATION



**FIG.**  
**1012 #3 BLK**

**FLEXIBLE  
PLASTIC  
STRIKE**



Type	Adjustment Latch Bar Inches	Dimensions Face Plate Inches	Display Pkg. - 5 Cards 1 Pc. per Card	OEM Bulk Pkg. 25 Pcs.	Weight Ounces
Lock	3/8 to 3	2-7/8 x 2-7/8	1011 DP1 BLK	1011 001 BLK	7-1/2
Lock	3/8 to 3	2-7/8 x 2-7/8	1011 DP2 BLK	1011 002 BLK	7
Lock	1-1/16 to 2-9/16	2-7/8 x 2-7/8	1011 DP3 BLK	1011 003 BLK	7-1/2
Latch	3/8 to 3	2-7/8 x 2-7/8	1012 DP1 BLK	1012 001 BLK	7-1/2
Latch	3/8 to 3	2-7/8 x 2-7/8	1012 DP2 BLK	1012 002 BLK	7
Latch	1-1/16 to 2-9/16	2-7/8 x 2-7/8	1012 DP3 BLK	1012 003 BLK	7

Spare Flush Cam Bar, Cat. No. 931 001 99A.  
Spare Offset Adjustable Cam Bar, Cat. No. 931 002 99A.  
Spare Straight Cam Bar, Cat. No. 931 003 99A.



**FIG. 1031**



**FIG. 1032**

### FIGS. 1031 & 1032 - FLUSH LOCK & LATCH

**CHROME PLATED ZINC. BLACK OR WHITE PLASTIC, WITH STAINLESS STEEL STEM AND LOCK NUT. LARGE HANDLE ALLOWS TWO FINGER GRIP.**

**FIG. 1031 - LOCK WITH 2 KEYS**

**FIG. 1032 - LATCH (NON-LOCKING)**

Flush Mounts in a 2-3/8 x 2-3/8 Inch Hole.  
Surface Mounts in a 1-5/8 Inch Diameter Hole  
With Plastic Spacer Included.  
For Door Thickness 1/8 to 3/4 Inches.

### ORDERING INFORMATION

Finish	Type	Adjustment Latch Bar Inches	Dimensions Face Plate Inches	Display Pkg. - 5 Cards 1 Pc. per Card	OEM Bulk Pkg. 25 Pcs.	Weight Ounces
Black	Lock	1/2 to 3	3-1/8 x 3-1/8	1031 DP1 BLK	1031 001 BLK	10
Black	Latch	1/2 to 3	3-1/8 x 3-1/8	1032 DP1 BLK	1032 001 BLK	10
White	Lock	1/2 to 3	3-1/8 x 3-1/8	1031 DP1 WHT	1031 001 WHT	10
White	Latch	1/2 to 3	3-1/8 x 3-1/8	1032 DP1 WHT	1032 001 WHT	10



## FLUSH HATCH DOG, LOCK & LATCH COVER & TRIM RINGS

**FIG. 777 - FLUSH HATCH DOG**

**CHROME PLATED BRASS  
STAINLESS STEEL LOCK NUTS  
WITH FLUSH STRIKE**

For Securely "Dogging" (Fastening) Deck Hatches.



**FIG. 777**

**ORDERING INFORMATION**

For Maximum Hatch Thickness Inches	Adjustment Latch Bar Inches	Dimensions Face Plate Inches	Standard Pkg. - 1 Pc. OEM Pkg. - 5 Pcs.	Screw Size	Weight Ounces
2	1-1/4 to 2	3-13/16 x 3	777 000 CHR	8	14

**FIG. 1089 - LOCK & LATCH COVER**

**BLACK OR WHITE  
FIBER REINFORCED PLASTIC  
HINGED, WATER RESISTANT**

**No. 1 - FITS FIGS. 931 AND 932  
No. 3 - FITS FIGS. 1031 AND 1032**

**ORDERING INFORMATION**



**FIG. 1089**

Finish	Fits Fig. No.	Dimensions Overall Inches	Display Pkg. - 5 Cards 1 Pc. per Card	OEM Bulk Pkg. 25 Pcs.	Weight Ounces
		Black	931/932	2-3/4 x 3-1/4	
Black	931/932	3-1/4 x 3-3/4	1089 DP3 BLK	1089 003 BLK	3
White	931/932	2-3/4 x 3-1/4	1089 DP1 WHT	1089 001 WHT	2
White	931/932	3-1/4 x 3-3/4	1089 DP3 WHT	1089 003 WHT	3

**FIGS. 1024 & 1025 - TRIM RINGS**

**CHROME PLATED ZINC  
DESIGNED FOR USE WITH FIGS. 931 AND 932**

**FIG. 1024 - HAS GRIPPER TEETH ON THE UNDER SIDE FOR CARPETED SURFACES.**

**FIG. 1025 - HAS A FLAT UNDER SIDE FOR SMOOTH SURFACES.**



**FIG. 1024/1025 TRIM RING**



**FIG. 1024/1025 TRIM RING WITH FLUSH LOCK. FLUSH LOCK NOT INCLUDED.**

**ORDERING INFORMATION**

For Surface	Dimensions Overall Inches	Standard Pkg. - 5 Pcs. OEM Pkg. - 25 Pcs.	Weight Ounces
Carpet	2-7/8 x 2-7/8	1024 000 CHR	2
Smooth	2-7/8 x 2-7/8	1025 000 CHR	2

## LATCH SETS

### DETERMINING THE BEVEL REQUIRED ON A LOCK OR LATCH.

#### WHEN STANDING OUTSIDE

**IF THE DOOR OPENS AWAY FROM YOU, THEN YOU NEED A LOCK OR LATCH  
WITH A REGULAR BEVEL.**

**IF THE DOOR OPENS TOWARD YOU, THEN YOU NEED A LOCK OR LATCH  
WITH A REVERSE BEVEL.**



#### DOOR OPENING INWARD.

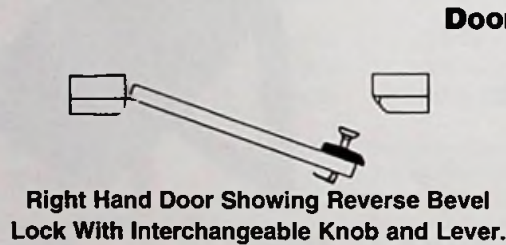
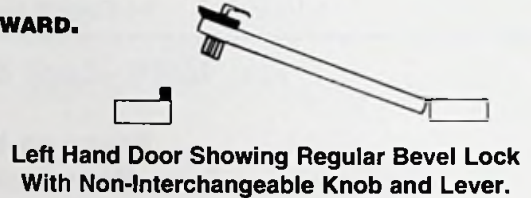

#### DOOR OPENING OUTWARD.

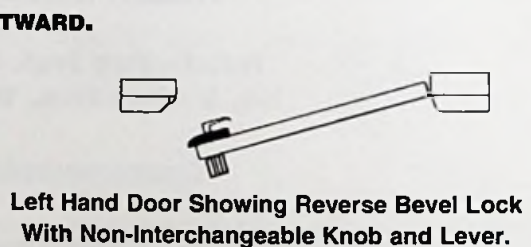

**ALL PERKO LOCK AND LATCH SETS MAY BE USED ON EITHER RIGHT OR LEFT HAND DOORS.**



**FIG. 567 - TUBULAR LATCH SET**



**CHROME PLATED ZINC**

**SLIDING LOCK BUTTON**

**FIG. 567`**

#### ORDERING INFORMATION

For Door Thickness Inches	Dimensions Escutcheon Inches	O.D. Tube Inches	Display Pkg. - 5 Cards 1 Set per Card	OEM Bulk Pkg. 10 Sets	Screw Size	Weight Pounds
1 to 1-3/8	4-3/8 x 1-1/4	3/4	567 DP CHR	567 000 CHR	6	3/4

Spare Flush Strike, Cat. No. 912 000 CHR.  
Spare Knob and Handle Assembly, Cat. No. 962 000 CHR.



## LATCH SETS

### FIGS. 1239 & 1240 - FLUSH CUP RIM LATCH SETS

**CHROME PLATED ZINC  
SLIDING LOCK BUTTON**

**FIG. 1239 - REGULAR BEVEL WITH BOX STRIKE**  
**FIG. 1240 - REVERSE BEVEL WITH FLUSH STRIKE**

Supplied with Black Plastic Spacer For Surface Mounting.  
For Door Thickness 5/8 to 1 Inch.

#### ORDERING INFORMATION

Bevel Type	Dimensions		Display Pkg. - 5 Sets 1 Set per Pkg.	OEM Bulk Pkg. 10 Sets	Weight Pounds
	Case Inches	O.D. Cup Inches			
Regular	2 x 2-1/4	2-1/4	1239 DP CHR	1239 000 CHR	1
Reverse	2 x 2-1/4	2-1/4	1240 DP CHR	1240 000 CHR	1

Case and Cup Both, Screw Size #8.

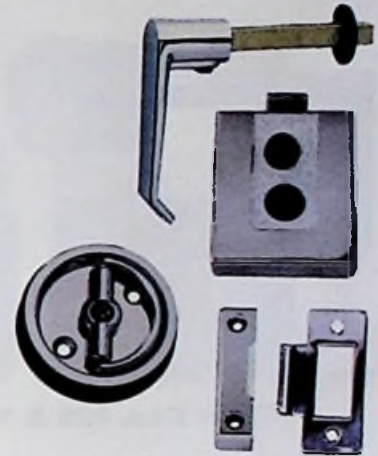

**FIGS. 1239 & 1240**

Spare Box Strike, Cat. No. 977 000 CHR.  
Spare Flush Strike, Cat. No. 912 000 CHR.

Spare Regular Bevel with Cam, Cat. No. 984 000 CHR.  
Spare Reverse Bevel with Cam, Cat. No. 920 000 CHR.

### FIGS. 991 & 992 - MORTISE LATCH SETS

**CHROME PLATED ZINC  
SLIDING LOCK BUTTON**

For Door Thickness 1/2 to 3/4 Inches.

**FIG. 991 - REGULAR BEVEL WITH FLUSH STRIKE**

**FIG. 992 - REVERSE BEVEL WITH FLUSH STRIKE**

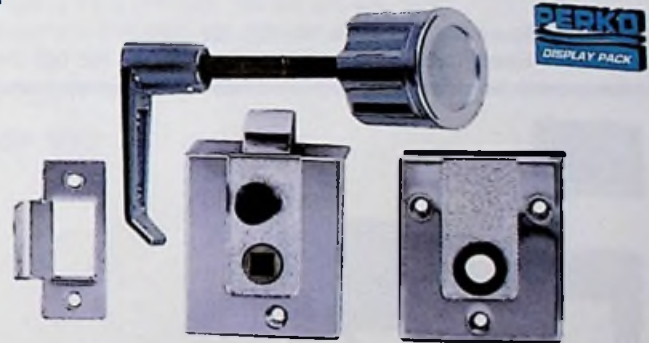

**FIGS. 991 & 992**

**EXPLODED  
VIEW SHOWS  
FIG. 992**

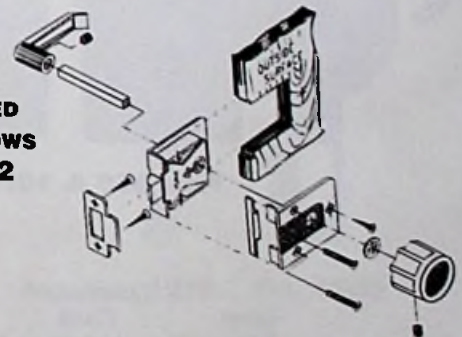

#### ORDERING INFORMATION

Bevel Type	Dimensions		Display Pkg. - 5 Sets 1 Set per Pkg.	OEM Bulk Pkg. 10 Sets	Screw Size	Weight Pounds
	Case Inches	Dimensions Escutcheon Inches				
Regular	1-5/8 x 1-5/8	2 x 2-1/4	991 DP CHR	991 000 CHR	6	1
Reverse	1-5/8 x 1-5/8	2 x 2-1/4	992 DP CHR	992 000 CHR	6	1

Spare Flush Strike, Cat. No. 912 000 CHR.  
Spare Knob and Handle, Cat. No. 995 000 CHR.

Spare Regular Bevel with Cam, Cat. No. 984 000 CHR.  
Spare Reverse Bevel with Cam, Cat. No. 920 000 CHR.

## LATCH SETS



### FIGS. 929 & 1029 - RIM LATCH SET

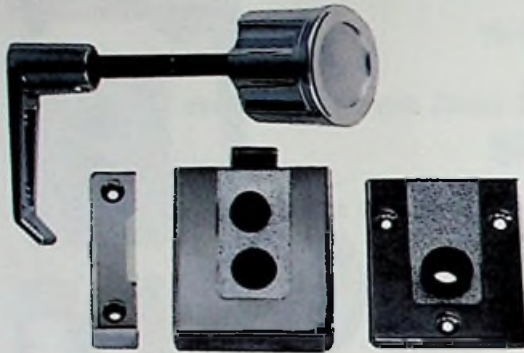

#### CHROME PLATED ZINC SLIDING LOCK BUTTON

For Door Thickness 1/2 to 1 Inch.

**FIG. 929 - REGULAR BEVEL WITH BOX STRIKE**  
**FIG. 1029 - REVERSE BEVEL WITH BOX STRIKE**

**Figs. 929 & 1029**

#### ORDERING INFORMATION

Bevel Types	Dimensions	Dimensions	Display Pkg. - 5 Sets 1 Set per Card	OEM Bulk Pkg. 10 Sets	Screw Size	Weight Pounds
	Case Inches	Escutcheon Inches				
Regular	2 x 2-1/4	2 x 2-1/4	929 DP CHR	929 000 CHR	6	3/4
Reverse	2 x 2-1/4	2 x 2-1/4	1029 DP CHR	1029 000 CHR	6	3/4

Spare Box Strike, Cat. No. 977 000 CHR.

Spare Regular Bevel with Cam, Cat. No. 984 000 CHR.

Spare Knob and Handle Assembly, Cat. No. 995 000 CHR.

Spare Reverse Bevel with Cam, Cat. No. 920 000 CHR.



### FIGS. 968 & 1068 - RIM LATCH SET

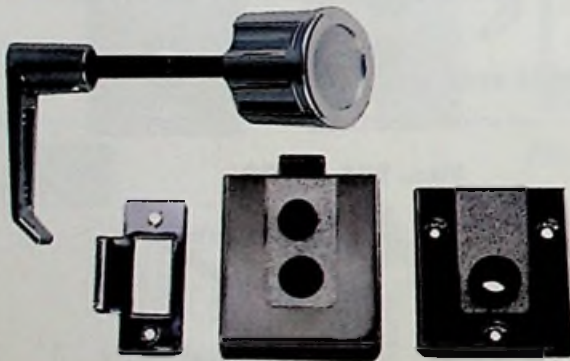

#### CHROME PLATED ZINC SLIDING LOCK BUTTON

For Door Thickness 1/2 to 1 Inch.

**FIG. 968 - REGULAR BEVEL WITH FLUSH STRIKE**  
**FIG. 1068 - REVERSE BEVEL WITH FLUSH STRIKE**

**Figs. 968 & 1068**

#### ORDERING INFORMATION

Bevel Type	Dimensions	Dimensions	Display Pkg. - 5 Sets 1 Set per Card	OEM Bulk Pkg. 10 Sets	Screw Size	Weight Pounds
	Case Inches	Escutcheon Inches				
Regular	2 x 2-1/4	2 x 2-1/4	968 DP CHR	968 000 CHR	6	3/4
Reverse	2 x 2-1/4	2 x 2-1/4	1068 DP CHR	1068 000 CHR	6	3/4

Spare Flush Strike, Cat. No. 912 000 CHR.

Spare Regular Bevel with Cam, Cat. No. 984 000 CHR.

Spare Knob and Handle Assembly, Cat. No. 995 000 CHR.

Spare Reverse Bevel with Cam, Cat. No. 920 000 CHR.



**LATCH & LOCK SETS**

**FIGS. 918 & 919 - RIM LOCK SET**



**CHROME PLATED ZINC**  
For Door Thickness 5/8 to 1-3/8 Inches.

**FIG. 918 - REGULAR BEVEL WITH BOX STRIKE**  
**FIG. 919 - REVERSE BEVEL WITH FLUSH STRIKE**

Locks by Turn Button from Inside or Key from Outside

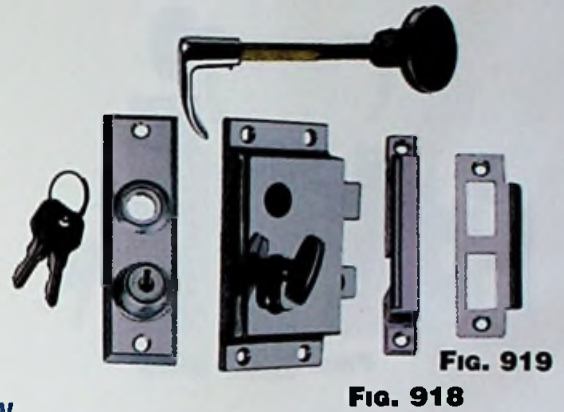

**ORDERING INFORMATION**

Bevel/Strike Type	Door Case Inches	Dimensions Escutcheon Inches	Dimensions Display Pkg. - 5 Sets 1 Set per Card	OEM Bulk Pkg. 10 Sets	Screw Size	Weight Pounds
Regular w/Box	3-7/8 x 2	4-3/8 x 1-1/4	918 DP CHR	918 000 CHR	6	1-1/4
Reverse w/Flush	3-7/8 x 2	4-3/8 x 1-1/4	919 DP CHR	919 000 CHR	6	1-1/4

Spare Box Strike, Cat. No. 918 000 99A. Spare Bevel with Cam for Both, Cat. No. 920 000 CHR.  
Spare Flush Strike, Cat. No. 913 000 CHR. Spare Escutcheon Plate with Keys, Cat. No. 953 000 CHR.  
Spare Knob and Handle Assembly, Cat. No. 962 000 CHR.

**FIGS. 1279 & 1280 - FLUSH CUP RIM LATCH SET**



**CHROME PLATED ZINC**  
**SLIDING LOCK BUTTON**  
For Door Thickness 3/4 to 1-1/8 Inches.

**FIG. 1279 - REGULAR BEVEL WITH BOX STRIKE**  
**FIG. 1280 - REVERSE BEVEL WITH FLUSH STRIKE**

Supplied with Black Plastic Spacer for Surface Mounting

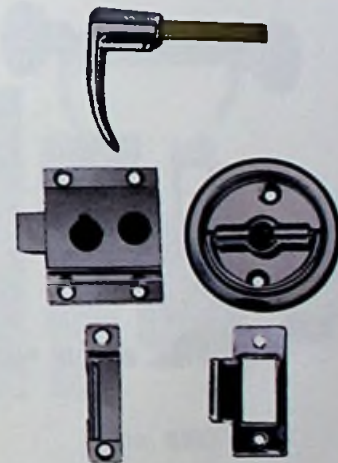

**ORDERING INFORMATION**

Bevel/Strike Type	Dimensions Case Inches	O.D. Cup Inches	Display Pkg. - 5 Sets 1 Set per Card	OEM Bulk Pkg. 10 Sets	Weight Pounds
Regular w/Box	2-1/8 x 1-3/4	2 x 2-1/4	1279 DP CHR	1279 000 CHR	1
Reverse w/Flush	2-1/8 x 1-3/4	2 x 2-1/4	1280 DP CHR	1280 000 CHR	1

Case Screw Size #6 Cup Screw Size #8  
Spare Box Strike, Cat. No. 976 000 CHR. Spare Regular Bevel with Cam, Cat. No. 984 000 CHR.  
Spare Flush Strike, Cat. No. 912 000 CHR. Spare Reverse Bevel with Cam, Cat. No. 920 000 CHR.

## LATCH SETS

### FIGS. 928 & 1028 - RIM LATCH SET

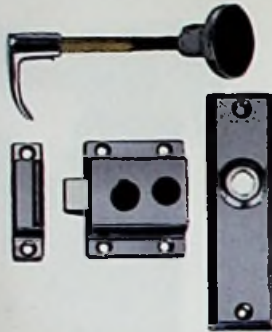

#### CHROME PLATED ZINC SLIDING LOCK BUTTON

For Door Thickness 5/8 to 1-3/8 Inches.

**FIG. 928 - REGULAR BEVEL WITH BOX STRIKE**  
**FIG. 1028 - REVERSE BEVEL WITH BOX STRIKE**

**Figs. 928 & 1028**

#### ORDERING INFORMATION

Bevel Type	Dimensions Case Inches	Dimensions Escutcheon Inches	Display Pkg. - 5 Sets 1 Set per Card	OEM Bulk Pkg. 10 Sets	Screw Size	Weight Pounds
Regular	2-1/8 x 1-3/4	4-3/8 x 1-1/4	928 DP CHR	928 000 CHR	6	3/4
Reverse	2-1/8 x 1-3/4	4-3/8 x 1-1/4	1028 DP CHR	1028 000 CHR	6	3/4

Spare Box Strike, Cat. No. 976 000 CHR.

Spare Knob and Handle Assembly, Cat. No. 962 000 CHR.

Spare Regular Bevel with Cam, Cat. No. 984 000 CHR.

Spare Reverse Bevel with Cam, Cat. No. 920 000 CHR.



### FIGS. 930 & 1030 - RIM LATCH SET

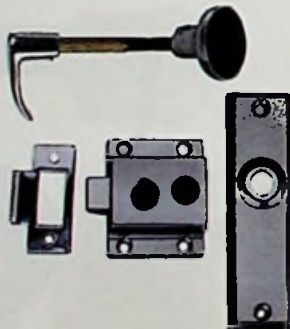

#### CHROME PLATED ZINC SLIDING LOCK BUTTON

For Door Thickness 5/8 to 1-3/8 Inches.

**FIG. 930 - REGULAR BEVEL WITH FLUSH STRIKE**  
**FIG. 1030 - REVERSE BEVEL WITH FLUSH STRIKE**

**Figs. 930 & 1030**

#### ORDERING INFORMATION

Bevel Type	Dimensions Case Inches	Dimensions Escutcheon Inches	Display Pkg. - 5 Sets 1 Set per Card	OEM Bulk Pkg. 10 Sets	Screw Size	Weight Pounds
Regular	2-1/8 x 1-3/4	4-3/8 x 1-1/4	930 DP CHR	930 000 CHR	6	3/4
Reverse	2-1/8 x 1-3/4	4-3/8 x 1-1/4	1030 DP CHR	1030 000 CHR	6	3/4

Spare Flush Strike, Cat. No. 912 000 CHR.

Spare Knob and Handle Assembly, Cat. No. 962 000 CHR.

Spare Regular Bevel with Cam, Cat. No. 984 000 CHR.

Spare Reverse Bevel with Cam, Cat. No. 920 000 CHR.



## LATCH & LOCK SETS

**FIG. 927 - MORTISE LOCK SET**



**CHROME PLATED ZINC**

Locked by Turn Button from Inside or Key from Outside.  
Bevel can be Reversed During Installation.

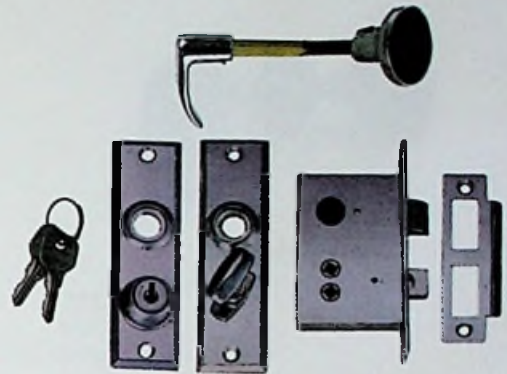

**FIG. 927**

**ORDERING INFORMATION**

For Door Thickness Inches	Dimensions Case Inches	Dimensions Escutcheon Inches	Display Pkg. - 5 Sets 1 Set per Sard	OEM Bulk Pkg. 10 Sets	Screw Size	Weight Pounds
1 to 1-3/8	2-3/4 x 2	4-3/8 x 1-1/4	927 DP CHR	927 000 CHR	6	1-1/4

Spare Flush Strike, Cat. No. 913 000 CHR.

Spare Bevel with Cam, Cat. No. 920 000 CHR.

Spare Knob and Handle Assembly, Cat. No. 962 000 CHR.

Spare Escutcheon Plate with Keys, Cat. No. 927 000 99B.

**FIG. 960 - MORTISE LATCH SET**



**CHROME PLATED ZINC  
TURN BUTTON LOCK**

Bevel can be Reversed During Installation.

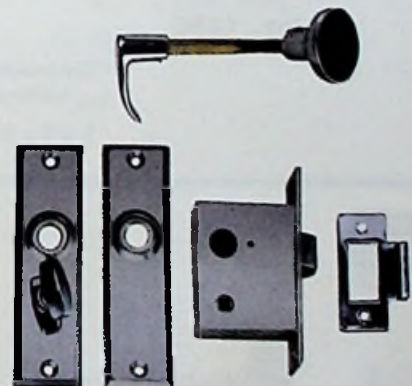

**FIG. 960**

**ORDERING INFORMATION**

For Door Thickness Inches	Dimensions Case Inches	Dimensions Escutcheon Inches	Display Pkg. - 5 Sets 1 Set per Card	OEM Bulk Pkg. 10 Sets	Screw Size	Weight Pounds
1 to 1-3/8	2-1/4 x 1-13/16	4-3/8 x 1-1/4	960 DP CHR	960 000 CHR	6	1

Spare Flush Strike, Cat. No. 912 000 CHR.

Spare Bevel with Cam, Cat. No. 920 000 CHR.

Spare Knob and Handle Assembly, Cat. No. 962 000 CHR.

## LATCH ASSEMBLY & ELBOW CATCHES



**FIG. 938 - PULL AND LATCH ASSEMBLY**

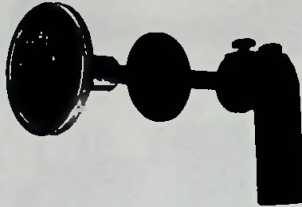

**FIG. 938**

**CHROME PLATED ZINC  
BLACK PLASTIC INSERT  
BRASS STEM**

**ORDERING INFORMATION**

O.D. Knob Inches	Max. Panel Thickness Inches	Display Pkg. - 5 Cards 1 Pc. per Card	OEM Bulk Pkg. 50 Pcs.	Weight Ounces
1-1/2	1-1/8	938 DP CHR	938 000 CHR	2

Spare Cam Bar, Cat. No. 938 000 99A.



**FIG. 1056 - ELBOW CATCH**



**FIG. 1056**

**CHROME PLATED ZINC  
STAINLESS STEEL SPRING**

**ORDERING INFORMATION**

Dimensions Inches	Display Pkg. - 10 Cards 1 Pc. per Card	OEM Bulk Pkg. 50 Pcs.	Screw Size	Weight Ounces
1-1/8 x 9/16	1056 DP CHR	1056 000 CHR	6	3/4



**FIG. 1021 - ELBOW CATCH**



**FIG. 1021**

**BLACK PLASTIC  
INTEGRAL SPRING**

**ORDERING INFORMATION**

Dimensions Inches	Display Pkg. - 25 Cards 2 Pcs. per Card	OEM Bulk Pkg. 100 Pcs.	Screw Size	Weight Ounces
1-3/16 x 5/8	1021 DP CHR	1021 000 CHR	6	1/2





## KNOB & FLUSH RING CATCH

**FIG. 925 - KNOB**



**CHROME PLATED BRASS  
STAINLESS STEEL SCREW**



**FIG. 925**

**ORDERING INFORMATION**

O.D. Inches	Max. Panel Thickness Inches	Display Pkg. - 10 Cards 1 Pc. per Card	OEM Bulk Pkg. 50 Pcs.	Weight Ounces
1	1-1/8	925 DP CHR	925 000 CHR	1-1/2

**FIG. 926 - KNOB**



**CHROME PLATED ZINC  
BLACK PLASTIC INSERT  
STAINLESS STEEL SCREW**



**FIG. 926**

**ORDERING INFORMATION**

O.D. Knob Inches	Max. Panel Thickness Inches	Display Pkg. - 10 Cards 1 Pc. per Card	OEM Bulk Pkg. 100 Pcs.	Weight Ounces
1-1/8	1-1/8	926 DP0 CHR	926 000 CHR	3/4
1-1/2	1-1/8	926 DP1 CHR	926 001 CHR	1

**FIG. 1051 - FLUSH RING CATCH**



**CHROME PLATED ZINC  
PHOSPHOR BRONZE SPRING**

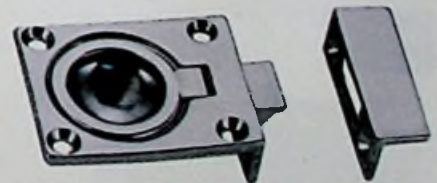

**FIG. 1051**

**ORDERING INFORMATION**

Dimensions Inches	Display Pkg. - 10 Cards 1 Pc. per Card	OEM Bulk Pkg. 25 Pcs.	Screw Size	Weight Ounces
2-1/4 x 1-3/8	1051 DP CHR	1051 000 CHR	6	1-1/2

## FLUSH PULLS



**Fig. 841**

**FIG. 841 - FLUSH RING PULL**

**CHROME PLATED ZINC**

**ORDERING INFORMATION**

Dimensions Face Plate Inches	Display Pkg. - 10 Cards 1 Pc. per Card	OEM Bulk Pkg. 50 Pcs.	Screw Size	Weight Ounces
1-3/4 x 1-3/8	841 DP CHR	841 000 CHR	6	1



**Fig. 1232**

**FIG. 1232 - FLUSH PULL RING**

**CHROME PLATED ZINC**

**ORDERING INFORMATION**

O.D. Face Plate Inches	Display Pkg. - 5 Cards 1 Pc. per Card	OEM Bulk Pkg. 50 Pcs.	Screw Size	Weight Ounces
1-5/8	1232 DP1 CHR	1232 001 CHR	6	1
2	1232 DP2 CHR	1232 002 CHR	6	1-1/2



**Fig. 1103**

**FIG. 1103 - FLUSH RING PULL**

**CHROME PLATED BRONZE**

**ORDERING INFORMATION**

Dimensions Face Plate Inches	Display Pkg. - 5 Cards 1 Pc. per Card	OEM Bulk Pkg. 50 Pcs.	Screw Size	Weight Ounces
2-9/16 x 2	1103 DP CHR	1103 000 CHR	8	3-1/2



**Fig. 575**

**FIG. 575 - FLUSH LIFTING PULL**

**CHROME PLATED BRONZE**

**ORDERING INFORMATION**

Dimensions Face Plate Inches	Display Pkg. - 10 Cards 1 Pc. per Card	OEM Bulk Pkg. 50 Pcs.	Screw Size	Weight Ounces
2-5/8 x 2	575 DP CHR	575 000 CHR	8	3



## PULLS & LIFTING HANDLES

**FIG. 1221 - FLUSH PULL**

**CHROME PLATED ZINC  
BLACK PLASTIC FINISHING FLANGE**  
Spring Loaded, Can be Mounted Horizontally or Vertically.



**FIG. 1221**

**ORDERING INFORMATION**

Dimensions	Display Pkg. - 5 Cards	OEM Bulk Pkg.	Screw Size	Weight Ounces
Flange Inches	1 Pc. per Card	50 Pcs.		
3/4 x 3-1/4	1221 DP CHR	1221 000 CHR	8	3

**FIGS. 1286 & 1288 - RING PULLS**

**CHROME PLATED ZINC**

**FIG. 1286 - FOR SURFACE MOUNTING WITH BLACK PLASTIC SPACER**  
**FIG. 1288 - FOR FLUSH MOUNTING, EASILY INSTALLS IN A 2 INCH DIAMETER HOLE**



**FIG. 1286**

**ORDERING INFORMATION**

Type of Mounting	O.D. Cup Inches	Display Pkg. - 5 Cards	Screw Size	Weight Ounces
		1 Pc. per Card		
Surface	2-1/4	1286 DP CHR	8	3-1/2
Flush	2-1/4	1288 DP CHR	8	3-1/2

**FIG. 776 - FLUSH LIFTING HANDLE**

**CHROME PLATED BRONZE**

Size No. 2 (Not Shown) Has All Mounting Holes at Corners



**FIG. 776**

**ORDERING INFORMATION**

Dimensions Face Plate Inches	Dimensions Inside Handle Inches	Display Pkg. - 5 Cards	OEM Bulk Pkg.	Screw Size	Weight Ounces
		1 Pc. per Card	25 Pcs.		
3 x 2-1/4	1-7/8 x 1	776 DP1 CHR	776 001 CHR	10	3-1/2
3-3/4 x 2-3/4	2-3/16 x 1-3/16	776 DP2 CHR	776 002 CHR	10	5-1/2

**FIG. 1220 - FLUSH LIFTING HANDLE**

**CHROME PLATED ZINC**

**ORDERING INFORMATION**

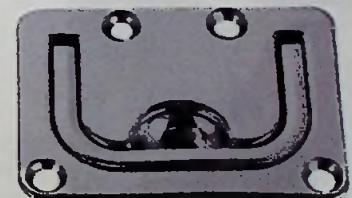

**FIG. 1220**

Dimensions Face Plate Inches	Dimensions Inside Handle Inches	Display Pkg. - 5 Cards	OEM Bulk Pkg.	Screw Size	Weight Ounces
		1 Pc. per Card	50 Pcs.		
3 x 2-1/4	1-7/8 x 1	1220 DP CHR	1220 000 CHR	8	3

## FLUSH PULLS & SLIDING WINDOW HANDLE



**Fig. 1110**

**FIG. 1110 - FLUSH PULL**

**CHROME PLATED ZINC**

**ORDERING INFORMATION**

Dimensions Face Plate Inches	Depth Inches	Display Pkg. - 5 Cards 1 Pc. per Card	OEM Bulk Pkg. 50 Pcs.	Screw Size	Weight Ounces
3-11/16 x 1-11/16	7/16	1110 DP CHR	1110 000 CHR	6	3



**Fig. 1016**

**FIG. 1016 - FLUSH PULL**

**BLACK OR WHITE PLASTIC**  
Easily Installs in a 1-3/4 Inch Diameter Hole

**ORDERING INFORMATION**

Color	Dimensions Face Plate Inches	Depth Inches	Display Pkg. - 10 Cards 1 Pc. per Card	OEM Bulk Pkg. 100 Pcs.	Screw Size	Weight Ounces
Black	2-1/4 x 2-1/4	15/16	1016 DP BLK	1016 000 BLK	6	1
White	2-1/4 x 2-1/4	15/16	1016 DP WHT	1016 000 WHT	6	1



**Fig. 958**

**FIGS. 958 - PULL**

**CHROME PLATED ZINC**

**ORDERING INFORMATION**

Width Overall Inches	Width Inside Inches	Display Pkg. - 10 Cards 1 Pc. per Card	Screw Size	Weight Ounces
3-7/16	2-5/16	958 DP CHR	6	1



**Fig. 954**

**FIG. 954 - SLIDING WINDOW HANDLE**

**STAINLESS STEEL**

**ORDERING INFORMATION**

For Glass Thickness Inches	Length Overall Inches	Display Pkg. - 5 Cards 1 Pc. per Card	Weight Ounces
1/4	3	575 DP CHR	1



## WINDOW STOPS, LOCKS & FASTENER

**FIG. 935 - SLIDING WINDOW STOP**

**CHROME PLATED ZINC  
PLASTIC COVER ON STOPPING PLATE**

**ORDERING INFORMATION**

Dimensions Mounting Plate Inches	Length Stopping Plate Inches	Display Pkg. - 5 Cards 1 Pc. per Card	OEM Bulk Pkg. 50 Pcs.	Screw Size	Weight Ounces
1-7/8 x 3/4	1-1/2	935 DP CHR	935 000 CHR	8	2



**FIG. 935**

**FIG. 937 - SLIDING WINDOW LOCK & ANTI-RATTLER**

**CHROME PLATED ZINC  
BLACK PLASTIC KNOB AND TIP**

**ORDERING INFORMATION**

Height Overall Inches	Dimensions Mounting Plate Inches	Adjustment Inches	Display Pkg. - 5 Cards 1 Pc. per Card	Screw Size	Weight Ounces
1-5/8	1 x 5/8	1-1/8	937 DP CHR	6	1-1/4



**FIG. 937**

Spare Black Plastic Tip, Cat. No. 944

**FIG. 934 - SLIDING WINDOW LOCK & ANTI-RATTLER**

**CHROME PLATED ZINC  
BLACK PLASTIC KNOB AND TIP**

**ORDERING INFORMATION**

Height Overall Inches	Dimensions Mounting Plate Inches	Adjustment Inches	Display Pkg. - 5 Cards 1 Pc. per Card	Screw Size	Weight Ounces
1	2 x 5/8	1-1/8	934 DP CHR	6	1-1/4

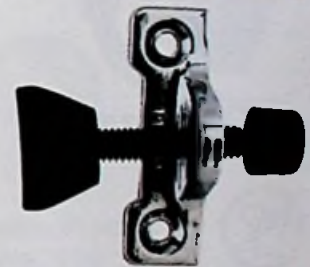

**FIG. 934**

Spare Black Plastic Tip, Cat. No. 944

**FIG. 719 - FASTENER**

**CHROME PLATED BRASS  
BLACK PLASTIC KNOB WITH STAINLESS STEEL STUD**

**ORDERING INFORMATION**

Length Angle Inches	Width Angle Inches	Display Pkg. - 5 Cards 1 Pc. per Card	OEM Bulk Pkg. 25 Pcs.	Screw Size	Weight Ounces
1-3/8	1	719 DP CHR	719 000 CHR	8	3



**FIG. 719**

Spare Knob, Cat. No. 719 000 99A  
Spare Sngle Bracket, Cat. No. 719 000 99B  
Spare Flat Plate, Cat. No. 719 000 99C

## UTILITY HOOKS



**FIG. 1106 - UTILITY HOOK**



**Fig. 1106**

**CHROME PLATED ZINC**

**ORDERING INFORMATION**

Projection Inches	Width Base Inches	Display Pkg. - 10 Cards 1 Pc. per Card	OEM Bulk Pkg. 50 Pcs.	Screw Size	Weight Ounces
3/4	1	1106 DP CHR	1106 000 CHR	6	3/4



**FIG. 975 - UTILITY HOOK**



**Fig. 975**

**CHROME PLATED ZINC**

**ORDERING INFORMATION**

Projection Inches	Width Base Inches	Display Pkg. - 10 Cards 1 Pc. per Card	OEM Bulk Pkg. 50 Pcs.	Screw Size	Weight Ounces
2	1-1/8	975 DP1 CHR	975 001 CHR	6	1
3	1-1/4	975 DP2 CHR	975 002 CHR	6	1-1/2



**FIG. 610 - UTILITY HOOK**



**Fig. 610**

**CHROME PLATED ZINC**

**ORDERING INFORMATION**

Projection Inches	Width Base Inches	Display Pkg. - 10 Cards 1 Pc. per Card	OEM Bulk Pkg. 50 Pcs.	Screw Size	Weight Ounces
1-3/8	1-1/8	610 DP CHR	610 000 CHR	6	1/2



## FASTENERS

### Figs. 869, 896, 898, 901 & 907 - "DURABLE TYPE" FASTENERS

**Figs. 896, 898, 901 & 907 - NICKEL PLATED BRASS**  
**FIG. 869 - STAINLESS STEEL, 5/8 INCH SELF TAPPING SCREW.**

For Canvas to Surface, Use Figs. 869, 896 and 898.  
 For Canvas to Canvas, Use Figs. 896, 898, 901 & 907.

#### ORDERING INFORMATION

Description	Std. Pkg. - 100 Pcs. OEM Pkg. - 500 Pcs.
Stud	869 000 STS
Stud	901 000 NKL
Socket	898 000 NKL
Button	896 000 NKL
Eyelet	907 000 NKL



**EYELET**  
FIG. 907



**SOCKET**  
FIG. 898



**BUTTON**  
FIG. 896



**STUD**  
FIG. 901



**STUD**  
FIG. 869



### Figs. 60, 62, 116, 117 & 118 - "LIFT TYPE" FASTENERS

**Figs. 60, 62, 116 & 118 - NICKEL PLATED BRASS**  
**FIG. 117 - STAINLESS STEEL, 1/2 INCH SELF TAPPING SCREW.**

#### ORDERING INFORMATION

Description	Standard Pkg. - 100 Pcs.
Clinch Stud	60 000 NKL
Clinch Washer	62 000 NKL
Clinch Plate	118 000 NKL
Stud	*117 000 STS
Socket	116 000 NKL

\*OEM Pkg. - 500 pcs.



**CLINCH WASHER**  
FIG. 62



**SOCKET**  
FIG. 116



**CLINCH PLATE**  
FIG. 118



**CLINCH STUD**  
FIG. 60



**STUD**  
FIG. 117



### Figs. 994, 996 & 997 - CURTAIN FASTENERS

**NICKEL PLATED BRASS**

#### ORDERING INFORMATION

Description	Standard Pkg. - 100 Pcs.
Flanged Stud	994 000 NKL
Eyelet	996 000 NKL
Washer	997 000 NKL



**WASHER**  
FIG. 997



**EYELET**  
FIG. 996



**FLANGED STUD**  
FIG. 994



## CONVERTIBLE TOP FITTINGS, UTILITY HOOK & BOAT COVER SOCKETS



**SOCKET**  
Fig. 395#3



**SLIDE**  
Figs. 395#6 & 395 #S



**SIDE PLATE**  
Fig. 395#8

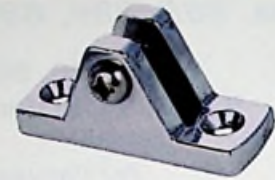

**HINGE**  
Fig. 395#1 & 395 #H



**EYE END**  
Figs. 395#5 & 395#9

### FIG. 395 - CONVERTIBLE TOP FITTINGS

**CHROME PLATED ZINC  
STAINLESS STEEL SCREWS**

#### ORDERING INFORMATION

Description	Display Pkg. - 5 Cards 2 Pcs. per Card	OEM Bulk Pkg. 100 Pcs.	Screw Size	Average Weight Ounces
Hinge for 3/4" fittings	395 DP1 CHR	395 001 CHR	8	2
Socket for 3/4" tubing	395 DP3 CHR	395 003 CHR	---	2
Eye End for 3/4" tubing with .049" wall	395 DP5 CHR	*395 005 CHR	---	2
Slide for 3/4" tubing	395 DP6 CHR	395 006 CHR	---	2
Side Mounting Plate	395 DP8 CHR	395 008 CHR	10	2
Eye End for 7/8" tubing	395 DP9 CHR	395 009 CHR	---	2
Slide for 7/8" tubing	395 DPS CHR	**395 010 CHR	---	2
Hinge for 7/8" fittings	395 DPH CHR	**395 011 CHR	8	2



\*OEM Bulk Pkg. - 200 pcs.  
\*\*OEM Bulk Pkg. - 50 pcs.

### FIG. 1249 - UTILITY HOOK

**CHROME PLATED ZINC**

#### ORDERING INFORMATION



**Fig. 1249**

Length Overall Inches	Width Overall Inches	Inside Hook Inches	Display Pkg. - 10 Cards 5 Pcs. per Card	OEM Bulk Pkg. 100 Pcs.	Screw Size	Weight Ounces
15/16	1/2	1/4	1249 DP CHR	1249 000 CHR	6	1/2



### FIG. 578 - BOAT COVER SOCKETS

**CHROME PLATED ZINC**

**Will Accommodate 3/8 Inch Wood or Plastic Battens  
Up To 1-3/4 Inches Wide.**

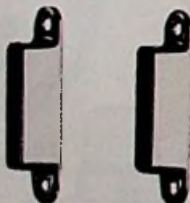

**Fig. 578**

Length Overall Inches	Dimensions Opening Inches	Width Overall Inches	Display Pkg. - 10 Cards 1 Pair per Card	Screw Size	Weight per Pair Ounces
3-1/4	1-7/8 x 7/16	5/8	578 DP CHR	6	1/2



#### ORDERING INFORMATION



## OUTRIGGER POLE HOLDERS

**FIG. 425 - FLYING BRIDGE RELEASE OUTRIGGER POLE HOLDERS**

**STAINLESS STEEL MAIN TUBE AND SUPPORT ARMS  
CHROME PLATED BRONZE FITTINGS.**

An adjustable length, hinged support arm allows the pole holder to be raised and lowered remotely with the use of a line running through an eye on the hinge and attached to the integral eye on the upper stop collar (Fig. No. 409). The main tube and both support arms have heavy swivel mounting bases for versatility of installation and use. Large knobs on the sliding clamps provide ready adjustment for all fishing positions. Stainless steel drift pins on both sliding clamps are pulled to release the pole holder to the down and aft position. Sturdy folding lay down hooks (Fig. No. 410) are included for supporting the outriggers in the down position. Also included are second stop collar (Fig. No. 415) for presetting the desired fishing angle, and a flying bridge holding bracket (Fig. No. 423) with a heavy swivel mounting base and hinge for quick release.

### ORDERING INFORMATION

"A" Length Main Tube Feet	Standard Pkg. - 1 Pair	"B" Length Upper Arm Inches	"C" Length Lower Arm Inches	Weight per Per Pounds
4	425 004 CHR	23 - 33	41-7/8	65
6	425 006 CHR	35 - 45	50-3/8	75
8	425 008 CHR	46 - 56	74-1/2	95

For Use With Outriggers Cat. Nos. 1798 019 ALU, 1798 019 BLK, 1798 022 ALU, 1798 022 BLK, 1798 025 ALU AND 1798 025 BLK.

Main Tube O.D. - 2".  
Mounting Flanges O.D. - 4".

Main Tube I.D. - 1.900".  
Bolt Size - 1/4".

### SPARE PARTS ORDERING INFORMATION

Spare Lower Stop Collar, Cat. No. 415 002 CHR.  
Spare Upper Stop Collar with Integral Eye, Cat. No. 409 000 CHR.  
Spare Lay Down Hook, Cat. No. 410 002 CHR.  
Spare Knob for Sliding Clamp Assembly, Cat. No. 401 000 CHR.  
Spare Holding Bracket, Cat. No. 423 000 CHR.

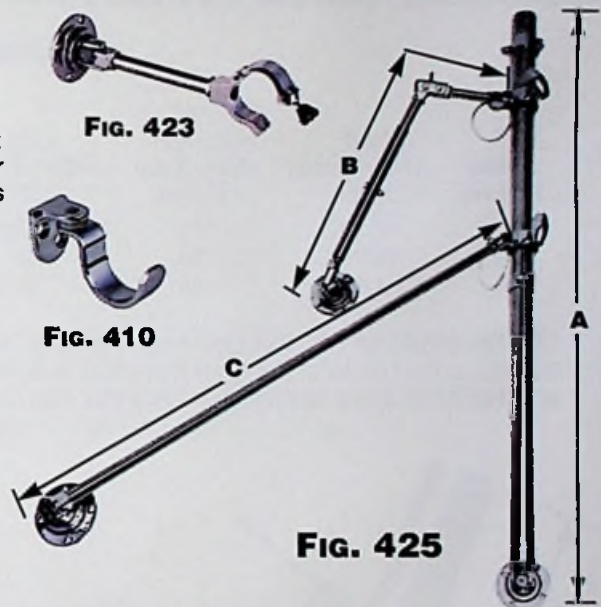

**FIG. 400 - OUTRIGGER POLE HOLDERS**

A large knob on the sliding clamps provide ready adjustment for all fishing positions. All joints swivel for easy installation and use. A stop collar, with an integral eye for the lifting line, is included for presetting the desired fishing angle. Sturdy folding lay down hooks (Fig. No. 410) are also included for supporting the outriggers in the down position. The upper holding bracket (Fig. No. 408) is hinged for quick release.

### ORDERING INFORMATION

"A" Length Main Tube Feet	Standard Pkg. - 1 Pair	"B" Length Upper Arm Inches	"C" Length Lower Arm Inches	Weight per Per Pounds
4	400 004 CHR	27-1/4	41-7/8	59
6	400 006 CHR	38-7/8	50-3/8	70
8	400 008 CHR	50-3/8	74-1/2	90

For Use With Outriggers Cat. Nos. 1798 019 ALU, 1798 019 BLK, 1798 022 ALU, 1798 022 BLK, 1798 025 ALU AND 1798 025 BLK.

Main Tube O.D. - 2".  
Mounting Flanges O.D. - 4".

Main Tube I.D. - 1.900".  
Bolt Size - 1/4".

### SPARE PARTS ORDERING INFORMATION

Spare Stop Collar, Cat. No. 409 000 CHR.  
Spare Lay Down Hook, Cat. No. 410 002 CHR.  
Spare Knob for Sliding Clamp Assembly, Cat. No. 401 000 CHR.  
Spare Holding Bracket, Cat. No. 408 000 CHR.

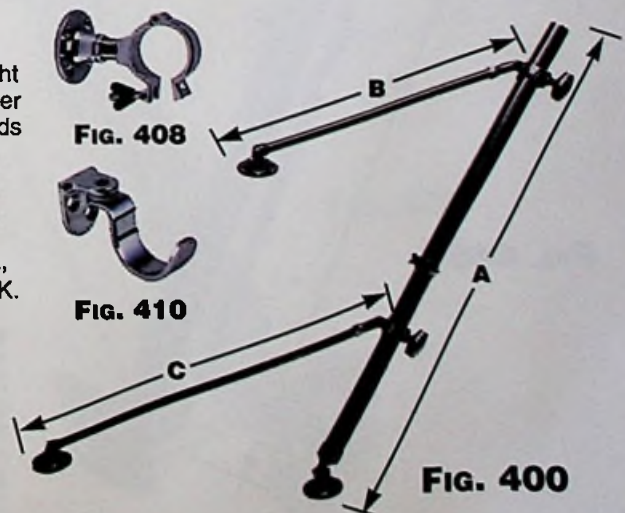



## OUTRIGGER POLE HOLDERS

**FIG. 445 - OUTRIGGER POLE HOLDERS**

**STAINLESS STEEL MAIN TUBE  
CHROME PLATED BRASS YOKE TUBING AND BRONZE FITTINGS.**

A large knob on the sliding clamp provides ready adjustment for all fishing positions. A stainless steel drift pin in the sliding clamp is pulled to release the pole holder to a down and aft position. Features include heavy bi-directional hinged mounting base for easy installation on a horizontal or vertical surface. A stop collar (Fig. No. 415) is included for presetting the desired fishing angle. Sturdy folding lay down hooks (Fig. No. 410) are also included for supporting the outriggers in the down position. The mounting yokes may be installed in an inverted position, rather than that shown, to accommodate various installation requirements.

### ORDERING INFORMATION

Holder Size No.	I.D. Main Tube Inches	"A" Length Main Tube Inches	O.D. Main Tube Inches	Standard Pkg. - 1 Pair	"B" Yoke Width Inches	Weight Per Pair Pounds	Bolt Size Inches
1	1.500	20	1-5/8	445 001 CHR	11-3/4	22	1/4
2	1.900	20	2	445 002 CHR	11-3/4	24	1/4
3	1.900	35	2	445 003 CHR	24	33	1/4

Size No. 1 For Use With Outrigger Poles Cat. Nos. 1798 016 ALU, 1798 016 BLK, 1798 018 ALU and 1798 018 BLK.

Size No. 2 For Use With Outrigger Poles Cat. Nos. 1798 019 ALU and 1798 019 BLK.

Size No. 3 For Use With Outrigger Poles Cat. Nos. 1798 019 ALU, 1798 019 BLK, 1798 022 ALU, 1798 022 BLK, 1798 025 ALU and 1798 025 BLK.

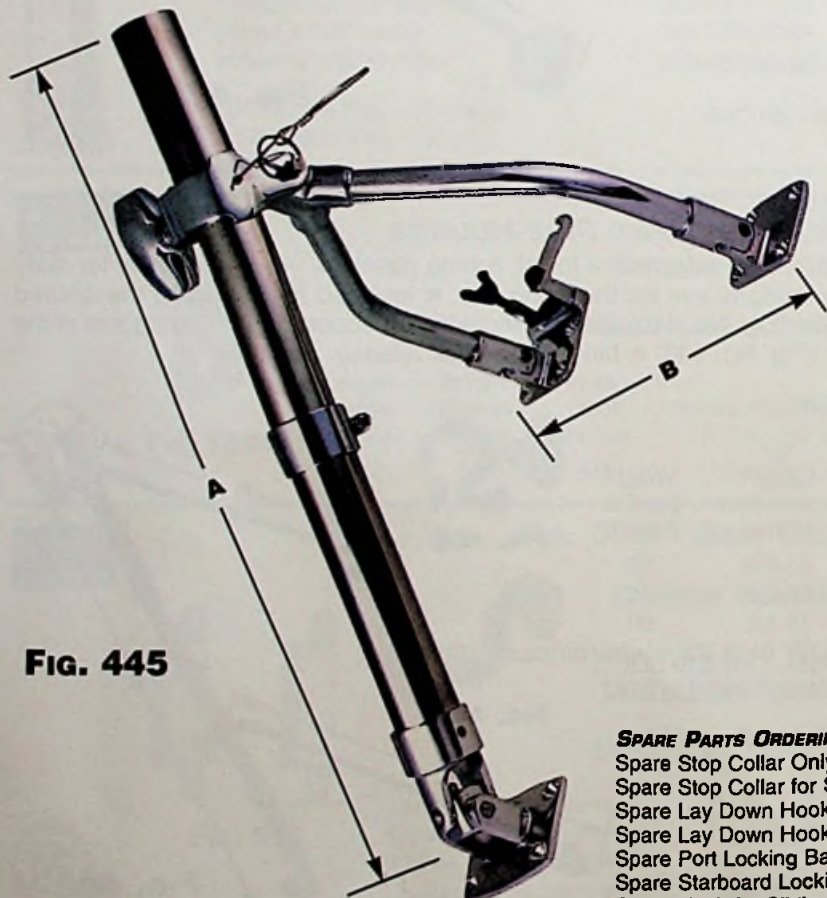

**FIG. 445**

Sizes 1 and 2 feature a retaining bar on one mounting bracket (as illustrated) to hold the outrigger in the vertical position.

Size 3 features a standard hinge holding bracket (Fig. No. 408) for quick release of the main tube.



**FIG. 410**



**FIG. 415**

### SPARE PARTS ORDERING INFORMATION

- Spare Stop Collar Only for Size 1 Holder, Cat. No. 415 001 CHR.
- Spare Stop Collar for Size 2 and 3 Holders, Cat. No. 415 002 CHR.
- Spare Lay Down Hook for Size 1 Holder, Cat. No. 410 001 CHR.
- Spare Lay Down Hook for Size 2 and 3 Holders, Cat. No. 410 002 CHR.
- Spare Port Locking Bar Assembly with Stud, Cat. No. 406 P00 99A.
- Spare Starboard Locking Bar Assembly with Stud, Cat. No. 406 S00 99A.
- Spare Knob for Sliding Clamp Assembly, Cat. No. 401 000 CHR.



## OUTRIGGER POLE HOLDERS

**FIG. 470 - OUTRIGGER POLE HOLDERS**

**STAINLESS STEEL MAIN TUBE  
CHROME PLATED BRASS YOKE TUBING AND BRONZE FITTINGS.**

A large knob on the sliding clamp provides ready adjustment for all fishing positions. A stainless steel drift pin in the sliding clamp is pulled to release the pole holder to a down and aft position. Features include a heavy swivel mounting base for easy installation on a horizontal or vertical surface. A stop collar (Fig. No. 415) is included for presetting the desired fishing angle. Sturdy folding lay down hooks (Fig. No. 410) are also included for supporting the outriggers in the down position. The mounting yokes may be installed in an inverted position, rather than that shown, to accommodate various installation requirements.

### ORDERING INFORMATION

Holder Size No.	I.D. Main Tube Inches	"A" Length Main Tube Inches	O.D. Main Tube Inches	Standard Pkg. - 1 Pair	"B" Yoke Width Inches	Weight Per Pair Pounds	Bolt Size Inches
1	1.500	20	1-5/8	470 001 CHR	11-3/4	22	1/4
2	1.900	20	2	470 002 CHR	11-3/4	24	1/4
3	1.900	35	2	470 003 CHR	24	33	1/4

Size No. 1 For Use With Outrigger Poles Cat. Nos. 1798 016 ALU, 1798 016 BLK, 1798 018 ALU and 1798 018 BLK.

Size No. 2 For Use With Outrigger Poles Cat. Nos. 1798 019 ALU and 1798 019 BLK.

Size No. 3 For Use With Outrigger Poles Cat. Nos. 1798 019 ALU, 1798 019 BLK, 1798 022 ALU, 1798 022 BLK, 1798 025 ALU and 1798 025 BLK.

Sizes 1 and 2 feature a retaining bar on one mounting bracket (as illustrated) to hold the outrigger in the vertical position.

Size 3 features a standard hinge holding bracket (Fig. No. 408) for quick release of the main tube.



**FIG. 410**



**FIG. 415**



**FIG. 470**

### SPARE PARTS ORDERING INFORMATION

- Spare Stop Collar Only for Size 1 Holder, Cat. No. 415 001 CHR.
- Spare Stop Collar for Size 2 and 3 Holders, Cat. No. 415 002 CHR.
- Spare Lay Down Hook for Size 1 Holder, Cat. No. 410 001 CHR.
- Spare Lay Down Hook for Size 2 and 3 Holders, Cat. No. 410 002 CHR.
- Spare Port Locking Bar Assembly with Stud, Cat. No. 406 P00 99A.
- Spare Starboard Locking Bar Assembly with Stud, Cat. No. 406 S00 99A.
- Spare Knob for Sliding Clamp Assembly, Cat. No. 401 000 CHR.

## OUTRIGGER POLE HOLDERS

**REMOVABLE TUBES LIFT AND TURN TO THREE POSITIONS: VERTICAL, FISHING AND LOWERED.  
UNIVERSAL TUBES MAY BE USED ON EITHER SIDE.  
SUPPLIED IN PAIRS CONSISTING OF TWO MOUNTS AND TWO TUBES.**



**FIG. 444**

### FIG. 444 - OUTRIGGER POLE HOLDERS

#### SIDE MOUNT

**Chrome Plated Bronze Brackets**  
Size 1 Tubes are Polished Stainless Steel.  
Size 2 Tubes are Chrome Plated Brass.

#### ORDERING INFORMATION

Holder Size No.	I.D. Tube Inches	O.D. Tube Inches	Dimensions Bracket Inches	Display Pkg. - 5 Pkgs. 1 Pair per Pkg.	Standard Pkg. - 1 Pair	Weight per Pair Pounds
1	1.120	1-1/4	4-1/2 x 3	444 DP1 CHR	-----	4-5/8
2	1.500	1-5/8	6-1/2 x 4	-----	444 002 CHR	8-1/4

Size 1 Bolt Size - 1/4".      Size 2 Bolt Size - 5/16".  
Spare Bracket For Size No. 1, Cat. No. 478 001 CHR.      Spare Bracket For Size No. 2, Cat. No. 478 002 CHR.  
See Fig. 451 for Outrigger Designations and Spare Tube Ordering.

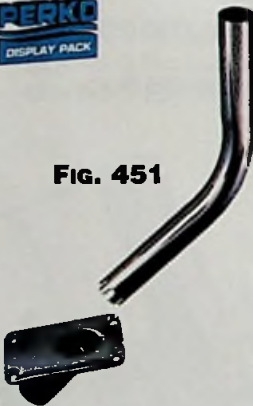

**FIG. 451**

### FIG. 451 - OUTRIGGER POLE HOLDERS

#### DECK MOUNT

**Chrome Plated Bronze Plates**  
Size 1 Tubes are Polished Stainless Steel.  
Size 2 Tubes are Chrome Plated Brass.

#### ORDERING INFORMATION

Holder Size No.	I.D. Tube Inches	O.D. Tube Inches	Dimensions Bracket Inches	Display Pkg. - 5 Pkgs. 1 Pair per Pkg.	Standard Pkg. - 1 Pair	Weight per Pair Pounds
1	1.120	1-1/4	5 x 2-1/2	451 DP1 CHR	-----	6-5/8
2	1.500	1-5/8	6 x 3-1/2	-----	451 002 CHR	11-1/4

Size 1 Bolt Size - 1/4".      Size 2 Bolt Size - 5/16".

Spare Tube Only For Figs. 444 & 451 Size 1, Cat. No. 479 DP1 STS.      Spare Plate Only for Size No. 1, Cat. No. 474 001 CHR.  
Spare Tube Only For Figs. 444 & 451 Size 2, Cat. No. 479 002 CHR.      Spare Plate Only for Size No. 2, Cat. No. 474 002 CHR.

Size No. 1 For Use With Outrigger Poles Cat. Nos. 460 015, 476 DP, 1798 015 ALU and 1798 015 BLK.  
Size No. 2 For Use With Outrigger Poles Cat. Nos. 1798 016 ALU, 1798 016 BLK, 1798 018 ALU and 1798 018 BLK.



**FIG. 1314**

### FIG. 1314 - OUTRIGGER POLE HOLDERS

#### DECK MOUNT

**Chrome Plated Zinc Plates.\*  
Stainless Steel Tubes.**  
For Fiberglass Outrigger Poles, Cat. Nos. 460 015 and 476 DP.

#### ORDERING INFORMATION

I.D. Tube Inches	O.D. Tube Inches	Dimensions Bracket Inches	Display Pkg. - 5 Pkgs. 1 Pair per Pkg.	OEM Bulk Pkg. 10 Pair	Bolt Size Inches	Weight per Pair Pounds
1.120	1-1/4	5 x 2-1/2	1314 DP CHR	1314 000 CHR	1/4	4-3/4

Spare Tube Only, Cat. No. 479 DP1 STS.      Spare Plate Only, Cat. No. 1320 000 CHR.

**\*NOT DESIGNED FOR USE WITH ALUMINUM POLES.**



## OUTRIGGER POLE KIT, LINE GUIDES & TROLLING PIN

**FIG. 476 - FIBERGLASS OUTRIGGER KIT**

**TELESCOPING FIBERGLASS  
WITH REINFORCED JOINTS**

One Pair of Fig. No. 460 Poles,  
Guides and Clips Included.

For Use With Nos. 444 DP1 CHR, 451 DP1 CHR and 1314 DP CHR Holders.

**ORDERING INFORMATION**

Open Length Overall Feet	O.D. Base Inches	Closed Length Overall Feet	Number of Sections	Display Pkg. - 3 Pkgs. 1 Kit per Pkg.	Weight per Pair Pounds
15	1.120	5-1/2	3	476 DP	3-1/2

Spare Pole Only, Cat. No. 460 015 98A.

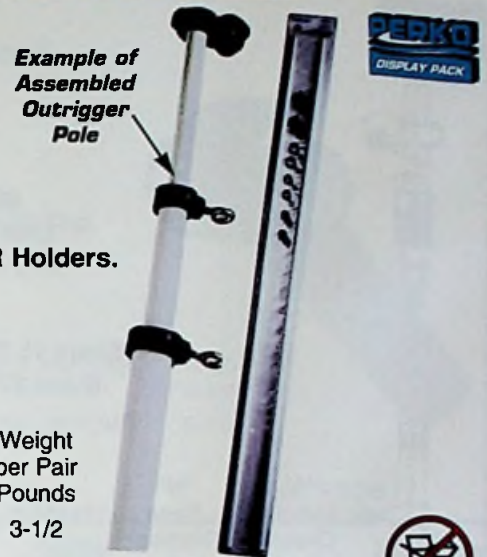

**FIG. 476**

**FIG. 471 - OUTRIGGER POLE ROLLER TIP LINE GUIDES**

**HIGH IMPACT BLACK PLASTIC  
WITH 7/8 INCH O.D. NYLON SHEAVE**

**ORDERING INFORMATION**

I.D. Body Inches	For Use With Outrigger Pole Size	Maximum Rope Size Inches	Display Pkg. - 5 Cards 1 Pair per Card	Weight per Pair Ounces
9/16	476	1/4	471 DP1 BLK	1
5/8	1798 015	1/4	471 DP2 BLK	1
3/4	1798 016 thru 025	1/4	471 DP3 BLK	1



**FIG. 471**

**FIG. 468 - OUTRIGGER POLE LINE GUIDES**

**HIGH IMPACT BLACK PLASTIC  
WITH 3/8 INCH I.D. STAINLESS STEEL EYE**

**ORDERING INFORMATION**

I.D. Body Inches	Display Pkg. - 5 Cards 2 Pcs. per Card	Weight per Pair Ounces
9/16	468 DP1 BLK	3
5/8	468 DP2 BLK	3-1/2
3/4	468 DP3 BLK	3-1/2
1	468 DP4 BLK	3-1/2
1-3/16	468 DP5 BLK	4
1-5/8	468 DP6 BLK	4-1/2



**FIG. 468**

**FIG. 469 - OUTRIGGER TROLLING PIN OR CLIP**

**HIGH IMPACT BLACK PLASTIC  
WITH STAINLESS STEEL EYES AND SPRING**

**ORDERING INFORMATION**

Dimensions Inches	Display Pkg. - 5 Cards 2 Pcs. per Card	Weight Ounces
2-3/4 x 1-3/8	469 DP BLK	1-1/2



**FIG. 469**

## OUTRIGGER POLES & SPREADERS

**FIG. 1798 - OUTRIGGER POLES**

**SILVER OR BLACK ANODIZED ALUMINUM  
WITH BLACK PLASTIC INSULATED BASE**

Sizes 15 Through 19 Have Standard (Fig. No. 468)  
Line Guides, Sizes 22 and 25 Have Integral Line Guides  
and All Sizes Have Tip Roller (Fig. No. 471) Line Guides.

Heavy Duty Poles For Rough Water Use.  
Sizes 15 Through 19 Have Sections Threaded For Easy Assembly,  
Sizes 22 and 25 Have Sections Thru-Bolted For Extra Strength.

### ORDERING INFORMATION

"A" Length Overall Feet	"B" Base Diameter Inches	Number Of Sections	Silver Standard Pkg. - 1 Pair Cat. No.	Black Standard Pkg. - 1 Pair Cat. No.	Silver Single Pole Only Cat. No.	Black Single Pole Only Cat. No.	Weight per Pair Pounds
15	1.120	4	1798 015 ALU	1798 015 BLK	1798 015 99A	1798 B15 99A	6-1/2
15	1.500	4	1798 016 ALU	1798 016 BLK	1798 016 99A	1798 B16 99A	8-1/4
18-2/3	1.500	5	1798 018 ALU	1798 018 BLK	1798 018 99A	1798 B18 99A	12-5/8
18-2/3	1.900	5	1798 019 ALU	1798 019 BLK	1798 019 99A	1798 B19 99A	12-3/4
22-1/4	1.900	6	1798 022 ALU	1798 022 BLK	1798 022 99A	1798 B22 99A	17-5/8
25-1/2	1.900	7	1798 025 ALU	1798 025 BLK	1798 025 99A	1798 B25 99A	24-5/8

**FIGS. 1714 & 1715 - SPREADERS**

**ANODIZED ALUMINUM  
SPREADER ARMS AND EYE BANDS  
SILVER OR GOLD FINISH.**

Designed For Use With Our Aluminum Outrigger Poles  
When Maximum Rigidity is Desired. Spreaders Are Suggested  
For Use On 18 and 19 Foot Outrigger Poles and  
Recommended For Use On 22 and 25 Foot Outrigger Poles.

Supplied in Pairs, Consisting of: Spreaders,  
Stainless Steel Cable, Eye Bands and Turnbuckles.

### ORDERING INFORMATION

For Use With Outrigger Poles Catalog Numbers	Silver Single Spreader Standard Pkg. - 1 Pair	Gold Single Spreader Standard Pkg. - 1 Pair	Silver Double Spreader Standard Pkg. - 1 Pair	Gold Double Spreader Standard Pkg. - 1 Pair
1798 018 ALU	1714 018	1714 018 GLD	-----	-----
1798 018 BLK	1714 018	1714 018 GLD	-----	-----
1798 019 ALU	1714 018	1714 018 GLD	-----	-----
1798 019 BLK	1714 018	1714 018 GLD	-----	-----
1798 022 ALU	1714 022	1714 022 GLD	1715 022	1715 022 GLD
1798 022 BLK	1714 022	1714 022 GLD	1715 022	1715 022 GLD
1798 025 ALU	-----	-----	1715 025	1715 025 GLD
1798 025 BLK	-----	-----	1715 025	1715 025 GLD

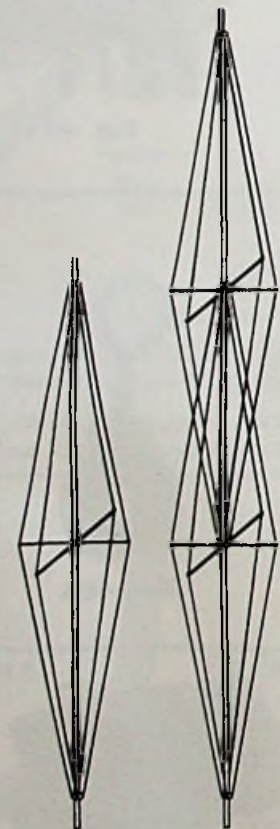
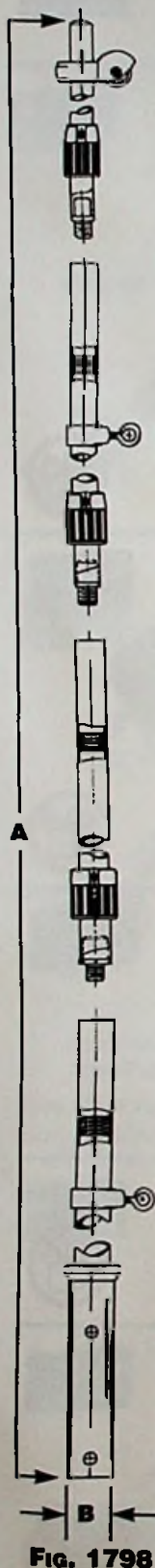



## FISHING ROD HOLDERS

### FIG. 1205 - FISHING ROD HOLDER



#### ANGLED FLUSH MOUNT

Chrome Plated Zinc Flange,  
Anodized Aluminum Tube  
With Soft Black Flange Gasket and Integral Flip-up Cap.



#### ORDERING INFORMATION

I.D. Tube Inches	O.D. Tube Inches	Length Under Flange Inches	Dimensions Flange Inches	Display Pkg. - 5 Pkgs. 1 Pc. per Pkg.	OEM Bulk Pkg. 20 Pcs.	Weight Pounds
1-5/8	2	8	4-1/4 x 3-1/2	1205 DP CHR	1205 000 CHR	1-1/2

Bolt Size 1/4".

FIG. 1205

### FIGS. 447 & 448 - FISHING ROD HOLDERS

#### ANGLED & VERTICAL FLUSH MOUNTS

Chrome Plated Bronze Flange,  
Chrome Plated Brass Tube.

Fig. 447 - Hard Black Plastic Liner.

Fig. 448 No. 1 - Soft Black Liner and Flange Gasket with Integral Flip-up Cap.

Fig. 448 No. 2 - Soft Black Liner with Lip Only.



FIG. 448-1



#### ORDERING INFORMATION

Mount Type	I.D. Tube Inches	O.D. Tube Inches	Length Under Flange Inches	Dimensions Flange Inches	Display Pkg. 5 Pkgs. 1 Pc. per Pkg.	OEM Bulk Pkg. 10 Pcs.	Bolt Size	Weight Pounds
Vertical	1-5/8	2	9	3-1/2 O.D.	447 DP1 CHR	447 001 CHR	10	1-1/4
Angled	1-5/8	2	8	4-1/4 x 3-1/2	448 DP1 CHR	448 001 CHR	1/4	2
Angled	1-7/8	2-1/4	12	4-7/8 x 4	*448 DP2 CHR	-----	1/4	3-3/8

\*Display Pkg. - 1 card, 1 Pc. per card.

FIG. 447

### FIG. 452 - FISHING ROD HOLDER



#### ANGLED FLUSH MOUNT

Polished Stainless Steel Flange,  
Stainless Steel Tube  
With Soft Black Flange Gasket and Integral Flip-up Cap.



FIG. 452

#### ORDERING INFORMATION

I.D. Tube Inches	O.D. Tube Inches	Length Under Flange Inches	Dimensions Flange Inches	Display Pkg. - 5 Pkgs. 1 Pc. per Pkg.	OEM Bulk Pkg. 20 Pcs.	Weight Pounds
1-5/8	2	8-1/4	4-1/8 x 3-3/8	452 DP STS	452 000 STS	1-3/8

Bolt Size #10.

#### SPARE PARTS ORDERING INFORMATION

Spare Liner with Lip and Tube, See Fig. 482 DP, Specify Size, Page 186.  
Spare Cap and Gasket Kit, See Figs. 480 DP and 481 DP, Specify Size, Page 186.

## FISHING ROD HOLDERS

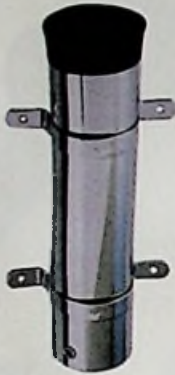

**FIG. 1100 - FISHING ROD HOLDER**

**SIDE MOUNT**

Chrome Plated Brass  
with Soft Black Liner.

**ORDERING INFORMATION**



**FIG. 1100**

I.D. Tube Inches	O.D. Tube Inches	Length Overall Inches	Width Bracket Inches	Display Pkg. - 5 Pkgs. 1 Pc. per Pkg.	Weight Pounds
1-5/8	2	9	3	1100 DP CHR	1-1/4

Bolt Size #8 R.H.

Spare Bracket, Cat. No. 1107 000 CHR.  
Spare Liner with Lip and Tube, Cat. No. 483 DP1 BLK.

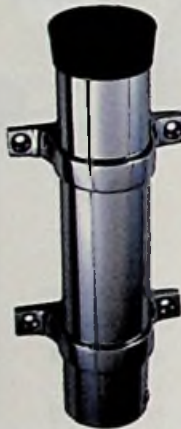

**FIG. 404 - HEAVY DUTY FISHING ROD HOLDER**

**SIDE MOUNT**

Chrome Plated Brass and Bronze  
with Soft Black Liner.

**ORDERING INFORMATION**



**FIG. 404**

I.D. Tube Inches	O.D. Tube Inches	Length Overall Inches	Width Bracket Inches	Display Pkg. - 5 Pkgs. 1 Pc. per Pkg.	Weight Pounds
1-5/8	2	9	4-3/16	404 DP1 CHR	2
1-7/8	2-1/4	11	4-3/4	*404 DP2 CHR	3-1/8

Bolt Size 1/4".

\* Display Pkg. - 1 card, 1 Pc. per card.

Spare Bracket for Size No. 1, Cat. No. 404 001 99A.  
Spare Bracket for Size No. 2, Cat. No. 404 002 99A.  
Spare Liner with Lip and Tube, See Fig. No. 483 DP, Specify Size, Page 186.



**FIG. 1104 - FISHING ROD HOLDER**

**SIDE MOUNT**

Black Plastic  
With Chrome Plated Brass Brackets.

**ORDERING INFORMATION**



**FIG. 1104**

I.D. Tube Inches	O.D. Tube Inches	Length Overall Inches	Width Bracket Inches	Display Pkg. - 5 Pkgs. 1 Pc. per Pkg.	Weight Pounds
1-5/8	2	9	3-1/4	1104 DP BLK	5/8

Bolt Size #8 R.H.

Spare Bracket, Cat. No. 1107 000 CHR.



**FISHING ROD HOLDERS**

**FIG. 1118 - FISHING ROD HOLDER**

**CLAMP ON**

Chrome Plated Brass and Bronze with Soft Black Liner.

Clamp-On Feature Eliminates Drilling Rail and Simplifies Relocation.

Mounts on Vertical or Horizontal Rails.

Adjustable For Rails 7/8 to 1 Inch in Diameter  
and by Reducing Mounting Bolt Length, 3/4 Inch Diameter Rails.

**ORDERING INFORMATION**

I.D. Tube Inches	O.D. Tube Inches	Length Overall Inches	Standard Pkg. - 1 Pc.	Weight Pounds
1-5/8	2	9	1118 000 CHR	2-1/4



**FIG. 1118**

Spare Face Plate with Bolts, Cat. No. 1118 000 99A.  
Spare Intermediate Plate, Cat. No. 1118 000 99B.  
Spare Liner with Lip and Tube, Cat. No. 483 DP1 BLK



**FIG. 1215 - FISHING ROD HOLDER**

**CLAMP ON**

Chrome Plated Zinc with Polished Stainless Steel Tube  
Hard Black Plastic Liner

Clamp-On Feature Eliminates Drilling Rail and Simplifies Relocation.

Mounts on Vertical or Horizontal Rails.

Adjustable For Rails 7/8 to 1 Inch in Diameter  
and by Reducing Mounting Bolt Length, 3/4 Inch Diameter Rails.

**ORDERING INFORMATION**

I.D. Tube Inches	O.D. Tube Inches	Length Overall Inches	Standard Pkg. - 1 Pc.	Weight Pounds
1-5/8	2	9	1215 DP CHR	2



**FIG. 1215**

Spare Face Plate with Bolts, Cat. No. 1215 000 99A.  
Spare Intermediate Plate, Cat. No. 1215 000 99B.

## FISHING ROD HOLDER, CAP & GASKET KITS AND LINERS, LIPS & TUBES



**FIG. 449 - FISHING ROD HOLDER**

**REMOVABLE**

Chrome Plated Brass and Manganese Bronze  
With Soft Black Liner.

Designed for Vertical Mounting, This Holder is Easily Removed  
When Not in Use, Leaving No Projecting Hardware.



**Fig. 449**

**ORDERING INFORMATION**

I.D. Tube Inches	O.D. Tube Inches	Dimensions Bracket Inches	Display Pkg. - 1 Card 1 Pc. per Card	Weight Pounds
1-5/8	2	4 x 3-3/4	449 DP CHR	2-1/4

Screw Size #10.

Spare Holder Only, Cat. No. 449 000 99A.

Spare Bracket Only, Cat. No. 449 000 99B.

Spare Liner with Lip and Tube, Cat. No. 483 DP1 BLK.



**FIGS. 480 & 481 - CAP AND GASKET KITS**

**REMOVABLE**

Soft Black Flange Gasket with Integral Flip-up Cap and Soft Black Lip.  
Replacement or Upgrade for Older Holders.



**Fig. 480**

**ORDERING INFORMATION**

To Fit Catalog Number	Display Pkg. - 5 Bags 1 Kit per Bag	Weight Ounces
448 DP1 CHR	480 DP BLK	3
1205 DP CHR	480 DP BLK	3
452 DP STS	481 DP BLK	3



**FIGS. 482 & 483 - LINERS, LIPS AND TUBES**

**FOR FISHING ROD HOLDERS**

Except Fig. Nos. 447, 1104 and 1215.



**Fig. 482**

**Fig. 483**

**ORDERING INFORMATION**

I.D. Inches	For Angled Flush Mount Complete Display Pkg. - 5 Bags 1 Set per Bag	For All Others Complete Display Pkg. - 5 Bags 1 Set per Bag	Spare Lip Only For Fig. 482 Display Pkg. - 5 Bags 1 Pc. per Bag	Spare Lip Only For Fig. 483 Display Pkg. - 5 Bags 1 Pc. per Bag
1-5/8	482 DP1 BLK	483 DP1 BLK	482 DP1 99A	483 DP1 99A
1-7/8	482 DP2 BLK	483 DP2 BLK	482 DP2 99A	483 DP2 99A





## NUMERICAL INDEX

FIG. No.	PAGE No.	FIG. No.	PAGE No.	FIG. No.	PAGE No.	FIG. No.	PAGE No.	FIG. No.	PAGE No.
4D	41	124	107	233	137	307	108	408	177
4F	30	125	13 & 17	236	120	308	61	409	177
5D	41	126	93	237	120	309	18 & 42	410	177 to 179
5F	30	127	86	244	62	310	72	411	139
7D	41	131	30 & 41	245	62	313	46	412	42
7F	30	132	63	246	33	315	81	413	126
24	33	133	43	247	35	318	63	414	105
42	77	134	40	248	35	322	98	415	177 & 179
52	33	135	2,5,8, & 11	249	40 & 44	323	97	420	86
60	175	136	1	250	28	324	105	423	177
62	175	137	64	252	3	325	127	424	77
63	102	138	33	253	7	326	100	425	177
64	4	139	3 & 7	254	7	328	100	429	121
65	103	140	64	255	73	329	28	432	66
66	103	142	98	256	35 & 44	330	84	433	45 & 46
67	34 & 79	144	86	257	61 & 63	334	85	434	121
68	22	148	139	258	145	335	85	435	45
69	34 & 79	149	145	259	35 & 44	336	85	440	45
70	34 & 79	150	86	260	35	337	34 & 79	441	80
71	34 & 79	152	145	261	35 & 44	339	81	444	180
72	34 & 79	153	86	263	106	340	34 & 79	445	178
74	35	155	142	265	66	341	39	447	183
75	100	157	2	266	106	342	44	448	183
76	102	158	87	268	35	344	122	449	186
82	140	159	87	269	35 & 44	347	44	450	67
86	103	162	80	271	150	348	99	451	180
91	29	163	78	272	150	349	80	452	183
92	29	164	78	273	35	350	99	454	43
93	25 to 27	165	78	276	33 & 42	351	122	455	19 & 128
95	27	166	86	277	35	354	46	460	181
98	29	170	2,6,22 to 24	278	35	355	46	465	86
99	29	171	86	280	66	357	108	468	181
105	72	172	86	281	35	359	140	469	181
106	35	179	87	283	35	362	18	470	179
107	1 & 5	180	127	284	35	363	106	471	181
108	18 & 28	185	127	285	97	365	97	474	180
109	28	196	78	286	33	366	72	476	181
110	28	197	151	289	35	370	106	477	20 & 128
111	28	200	25 to 27	290	33	371	18	478	180
112	18 & 42	201	35	291	33	373	41 & 44	479	180
113	86	212	145	292	33	374	34,40 & 44	480	186
114	7	217	67	294	41	375	34,35 to 27	481	186
116	175	218	123	296	35	380	126	482	186
117	175	219	123	298	35	381	72	483	186
118	175	220	123	299	105	395	176	491	125
119	115	221	123	300	61	400	177	492	128
120	2,6 22 to 24 & 151	222	18,27 & 28	301	100	401	177 to 179	493	88
121	78	223	67	302	33	402	178	495	123
122	151	226	18	303	44	403	42	499	96
123	86	230	33	305	46	404	184	500	88
		231	33	306	73	406	178 & 179	501	122



## NUMERICAL INDEX

FIG. No.	PAGE No.	FIG. No.	PAGE No.	FIG. No.	PAGE No.	FIG. No.	PAGE No.	FIG. No.	PAGE No.
502.....	128	614.....	133	820.....	54 & 55	899.....	60	960.....	167
503.....	83	626.....	75	825.....	102	901.....	175	962.....	162,
506.....	82	627.....	76	826.....	95	902.....	56	.....	165 to 167
507.....	91	629.....	75	828.....	138	903.....	119	963.....	5
508.....	91	634.....	129	829.....	138	904.....	1	964.....	11
509.....	83	647.....	76	830.....	138	905.....	56 & 60	965.....	8
510.....	81	659.....	134	831.....	138	907.....	175	967.....	143
513.....	90 to 92	669.....	139	832.....	138	908.....	56	968.....	164
514.....	63 & 74	688.....	74	833.....	138	910.....	56	969.....	46 & 53
515.....	83	694.....	75	834.....	101	911.....	60	970.....	4
517.....	74	697.....	143	835.....	101	912.....	163 to 165	972.....	2
518.....	82	701.....	73	836.....	54 & 55	913.....	165 & 166	975.....	174
520.....	92	703.....	73	837.....	54,55 & 59	915.....	5	976.....	157,158
521.....	92	704.....	104	839.....	54,55,59 & 60	918.....	165	.....	165 & 166
524.....	91	705.....	104	840.....	59	919.....	165	977.....	157,158
526.....	96	707.....	84	841.....	170	920.....	163 to 167	.....	165 & 166
527.....	92	708.....	80	842.....	135	921.....	158	978.....	157
528.....	90	709.....	104	844.....	54,55 & 59	922.....	158	980.....	158
530.....	111	714.....	107	845.....	54,55 & 59	924.....	152	983.....	158
531.....	74	719.....	173	846.....	54,55 & 59	925.....	169	984.....	157, 158
532.....	74	720.....	77	847.....	59	926.....	169	.....	163 to 166
533.....	130	721.....	104	848.....	59	927.....	167	986.....	157
534.....	45	722.....	104	851.....	46 & 51	928.....	166	987.....	149
535.....	45	732.....	131	852.....	46 & 53	929.....	164	988.....	149
537.....	95	737.....	107	859.....	59	930.....	166	991.....	163
538.....	45	741.....	118	860.....	54,55 & 59	931.....	159	992.....	163
539.....	96	742.....	107	863.....	121	932.....	159	994.....	175
544.....	111	750.....	118	866.....	60	934.....	173	995.....	163 & 164
545.....	111	752.....	117	869.....	175	935.....	173	996.....	175
546.....	115	753.....	63	870.....	81	937.....	173	997.....	175
550.....	84	754.....	131	872.....	54 & 59	938.....	168	998.....	152
554.....	156	757.....	118	873.....	54 & 59	939.....	8	999.....	149
555.....	63	759.....	119	874.....	54 & 59	940.....	8	1002.....	146
558.....	74	762.....	142	875.....	54	941.....	147	1004.....	146
559.....	156	769.....	143	876.....	54	942.....	150	1011.....	160
561.....	82	770.....	143	878.....	54	943.....	173	1012.....	160
562.....	132	773.....	148	879.....	54	944.....	173	1015.....	121
565.....	129	775.....	125	880.....	54 & 59	945.....	8	1016.....	172
566.....	109	776.....	171	881.....	132	946.....	8	1017.....	127
567.....	162	777.....	161	883.....	48 & 49	947.....	153	1021.....	168
570.....	82	786.....	76	884.....	50 & 51	948.....	158	1024.....	161
571.....	82	797.....	142	885.....	52 & 53	949.....	147	1025.....	161
572.....	110	805.....	101	889.....	56 & 60	951.....	148	1028.....	166
573.....	114	806.....	54,55 & 59	890.....	56 & 60	952.....	148	1029.....	164
574.....	155	807.....	54,55 & 59	891.....	56	953.....	165	1030.....	166
575.....	170	808.....	149	893.....	60	954.....	172	1031.....	159
578.....	176	809.....	54 & 59	894.....	60	955.....	5	1032.....	159
608.....	117	810.....	54,55 & 59	895.....	60	956.....	154	1040.....	66
610.....	174	811.....	54 & 55	896.....	175	957.....	152	1041.....	135
612.....	134	816.....	54 & 55	897.....	60	958.....	172	1042.....	135
613.....	134	817.....	54 & 55	898.....	175	959.....	152 & 154	1043.....	122



# NUMERICAL INDEX

FIG. No.	PAGE No.	FIG. No.	PAGE No.	FIG. No.	PAGE No.	FIG. No.	PAGE No.	FIG. No.	PAGE No.
1044	65	1150	39	1221	171	1301	20	1798	182
1045	4, 8, 14 & 31	1151	39	1222	124	1302	123	1901	57 to 60
1046	14 & 31	1152	39	1223	115	1303	67	1902	57 to 60
1047	4, 14 & 31	1154	39	1226	130	1305	112	1921	57 to 59
1048	14, 19 & 32	1155	137	1227	136	1306	114	1922	57 to 59
1049	19	1158	3, 11 to 13	1230	116	1307	116	1930	59
1050	122	1161	1	1231	125	1308	116	1931	59
1051	169	1164	38	1232	170	1309	133	1932	60
1052	12, 19 & 32	1165	38	1235	120	1310	1	1933	60
1053	154	1166	38	1238	84	1311	16	1936	60
1054	12, 19 & 32	1167	38	1239	163	1312	81	8501	69
1056	168	1168	38	1240	163	1313	94	8502	69
1057	118	1169	37	1242	132	1314	180	8503	69
1059	16, 17 & 31	1170	37	1243	131	1315	112	8504	69
10604	14, 16 & 31	1172	37	1244	154	1316	113	8505	71
1064	65	1173	37	1246	133	1319	94	8506	71
1065	156	1174	37	1247	95	1320	180	8603	71
1068	164	1175	108	1248	95	1323	63	9601	70
1087	64	1177	155	1249	176	1324	93	9602	70
1089	161	1178	11	1250	117	1325	122	9603	70
1090	64	1179	141	1251	109	1326	114	9604	70
1100	184	1180	141	1252	109	1330	17		
1101	157	1181	12	1253	61	1331	11		
1102	157	1183	12	1254	64	1332	9		
1103	170	1184	12	1255	129	1335	14		
1104	184	1185	137	1256	130	1336	124		
1105	37, 39 & 43	1186	137	1257	62	1346	124		
1106	174	1187	137	1258	62	1399	94		
1108	144	1188	110	1259	62	1400	15		
1109	33	1189	77	1260	62	1406	114		
1110	172	1190	77	1261	130	1410	1		
1111	43	1191	77	1262	136	1411	16		
1112	144	1192	20	1264	7	1413	93		
1113	144	1194	153	1267	136	1416	113		
1116	141	1196	12	1269	91	1430	14		
1117	141	1197	12	1270	93	1600	15		
1118	185	1198	153	1271	84	1601	7		
1119	37, 38 39 & 43	1199	155	1279	165	1602	7		
1123	13 & 32	1201	3	1280	165	1603	3		
1124	13 & 32	1205	183	1286	171	1605	2		
1125	13 & 31	1209	17 & 31	1287	155	1606	2		
1127	40	1210	110	1288	171	1611	16		
1128	40	1211	4	1289	134	1612	4		
1129	40 & 43	1212	4	1290	140	1613	94		
1130	40	1213	149	1291	140	1620	19		
1133	37 & 38	1214	149	1292	140	1630	17		
1134	19	1215	185	1293	147	1631	14		
1137	19	1216	156	1296	4	1640	14		
1143	37 & 38	1217	156	1297	126	1660	14		
1144	12 & 19	1218	1	1298	126	1714	182		
		1220	171	1299	133	1715	182		



## ALPHABETICAL INDEX

A	PAGE
Adapter - Pipe to Hose .....	102
Adjusters - Hatch .....	142
Windshield .....	140 & 141
All-Round Lights .....	12 to 20, 26 to 28, 31, 32 37 to 40, 42 & 43
Anchor Chocks .....	119
Anchor Lights .....	12 to 20, 26 to 28, 31, 32 37 to 40, 42 & 43
Assemblies, Control .....	46, 47, 51, 53, 57 & 59
Axe Brackets .....	127

B	PAGE
Bass Boat Lights .....	4
Bells - Fog .....	86 & 87
Berth Lights .....	72
Bits .....	117
Boarding Steps .....	122
Bolts - Barrel .....	153 & 154
Cupboard .....	157
Book, Log .....	80
Bow - & Anchor Lights .....	12 & 13
Combination Lights .....	1 to 4, 22 to 26
Eyes .....	120
Brackets - Axe .....	127
Table .....	139
Breakdown Lights .....	37 to 42
Bulbs, Electric .....	34, 44, 54 & 79
Butt Hinges .....	145 to 152
Buttons - Door .....	156
Horn Push .....	73

C	PAGE
Cabin - Door Hooks .....	154 & 155
Cabinet Hinges .....	148 to 152
Cable - Outlet .....	77
Straps .....	78
Caps, Gas Tank .....	93
Catches, Door .....	156, 157 & 168
Caulking Iron .....	108
Certification of Lights .....	VIII & 36
Chain - Deck Pipe .....	118
Portlight .....	80
Chocks .....	115 & 116
Chocks, Anchor .....	119
Clam Shell Ventilators .....	81

C - CONTINUED	PAGE
Clamps - Hatch Hold - Down .....	144
Spring .....	20 & 128
Rope .....	130
Cleats .....	109 to 114 & 121
Clips - Line Support .....	78
Trolling .....	181
Coat & Hat Hooks .....	174
Cockpit Scupper .....	97 & 98
Combination - Bow & Anchor Lights .....	12 & 13
Side Lights .....	5 to 7 & 22 to 26
Connections - Electric .....	77
Thru Hull .....	98 to 101
Watertight, Deck .....	77
Connectors, Electric .....	77
Connectors, Garden Hose .....	96
Continuous Hinge .....	145
Control - Assemblies .....	46, 47, 51, 53, 57 & 59
Convertible Boat Top - Fittings .....	176
Courtesy Lights .....	64 & 65
Cowl Ventilators .....	81
Cupboard - Bolts .....	157
Catches .....	156, 157 & 168
Turns .....	157
Curtain Fasteners .....	175

D	PAGE
Deck - Connection, Watertight .....	77
Lights .....	10 & 66
Pipes, Rope & Chain .....	118
Plate Keys .....	95
Plates .....	90 to 94 & 96
Dock Line Springs .....	119
Dome Lights .....	61 to 63
Door - Buttons .....	156
Catches .....	156, 157 & 168
Fasteners .....	143 & 144
Hinges .....	145 to 152
Holders .....	155 & 156
Hooks .....	154 & 155
Stops .....	155
Drain Plugs .....	105 to 107
Drawer - Knobs .....	169
Pulls .....	170 to 172
Dredging Light .....	43
Dorade Ventilator .....	81



## ALPHABETICAL INDEX

### E PAGE

Elbow Catches .....	168
Electric -	
Bulbs .....	34, 44, 54 & 79
Cabin Fixtures .....	61 to 67
Connections .....	77
Lamps .....	61 to 67
Sockets .....	31, 33, 44, 54, 55, 59 & 60
Switches .....	68 to 74
European Representative .....	VI
Eyes -	
Bow .....	120
Flange .....	120
Lashing .....	120 & 121
Lifting .....	121
Transom .....	120

### F PAGE

Fasteners -	
Curtain .....	175
Door .....	143 & 144
Hatch .....	143 & 144
Table Leg .....	173
Fender-	
Hooks .....	133
Locks .....	133
Filler, Tank .....	90 to 94
Filters, Fuel .....	105
Filters, Water .....	88 & 89
Fishing -	
Rod Holders .....	183 to 186
Fittings -	
For Boat Top .....	175 & 176
For Rails .....	125 & 126
Waste .....	91
Fixtures, Light -	
Bulkhead, Electric .....	61 to 67
Electric Cabin .....	61 to 67
Vapor Proof .....	64
Flag Pole -	
Sockets .....	123
Flag Staffs .....	123
Flange Eyes .....	120
Flush -	
Hatch Lifting Handles .....	161 to 171
Hatch Lifting Rings .....	169 & 170
Pulls .....	161, 163, 165 & 170 to 172
Ring Catch .....	169
Fog Horn .....	80
Fuel -	
Filter .....	105
Separator .....	105
Strainer .....	105
Tank Filler .....	90 to 94
Fuse -	
Holder .....	74 to 76
Panels .....	74 to 76

### G PAGE

Gas -	
Strainer .....	105
Tank Caps .....	90 to 94
Tank Filler .....	90 to 94
Tank Vents .....	82 & 83
Globes .....	35, 44 & 61 to 63
Grab Rail Posts .....	126
Grab Rails .....	125
Guides, Tiller Rope .....	130 & 131
Guides, Pole Line .....	181

### H PAGE

Halyard Mount Lights .....	27
Handles -	
Flush Lifting .....	161 & 171
Sliding Window .....	172
Utility .....	124 & 125
Hasps .....	152 & 153
Hatch -	
Adjusters .....	142
Dog .....	161
Fasteners .....	143, 144 & 161
Hinges .....	145
Hold-Down Clamps .....	144
Lifting Handles .....	161 & 171
Lifting Rings .....	169 to 171
Trim .....	145
Support Braces .....	142
Hawse Hole Plate .....	117
Heights, Vertical Light .....	21
Hinges -	
Butt .....	146 to 148
Cabinet .....	148 to 152
Continuous .....	145
Cuddy Door .....	146 to 152
Hatch .....	146 to 152
Hatch Support .....	142
Non-Mortised .....	152
Piano .....	145
Pull Apart .....	145
Rail .....	127
Semi-Concealed .....	150
Shortside .....	149 to 151
Strap .....	151
"T" .....	151
Holdings -	
Boat Hook .....	128
Door .....	155
Fishing Pole .....	183 to 186
Ring Buoy .....	128
Outrigger Pole .....	177 to 180
Hooks -	
Cabin Door .....	155 & 156
Coat Hook .....	174
Fender .....	133
Lashing .....	174



### H - CONTINUED PAGE

Ski Towing.....	121
Snap.....	133 to 135
Utility.....	174
Wardrobe.....	174
Horn Push Button.....	73
Horn, Fog.....	80
Horns for Rowlocks.....	136 & 138
Hull Connections.....	98 to 101

### I PAGE

Information -	
Certification of Navigation Lights.....	VIII & 36
Electrical Standards.....	68
Light, Vertical Heights.....	21
Lock Bevels.....	162
Representatives.....	VI
Searchlight Bulb Data.....	54, 55 & 59
Sales Policy & Terms.....	II
Warranty.....	II
Inlet -	
Fittings for Fresh Water.....	96
Strainer.....	103
Iron, Caulking.....	108

### K PAGE

Keys, Deck Plate.....	95
Knobs, Drawer.....	169

### L PAGE

Ladder Locks.....	139
Lamps -	
Cabin.....	61 to 67
Wall.....	61 to 67
Lashing Eyes.....	121 & 122
Lashing Hooks.....	174
Latches -	
Doors.....	158 to 160
Flush.....	159, 160, 163 & 165
Mortise Latch Sets.....	163 & 167
Rim Latch Sets.....	159, 160 & 162 to 166
Wood Rail.....	127
Leathers, Oar.....	137
Lenses.....	35, 44 & 61 to 63
Lifting Eyes.....	121
Light Chart, Vertical Heights.....	21
Lights -	
All-Round.....	12 to 20, 26 to 29, 31, 32, 37 to 40, 42 & 43
Anchor.....	12 to 20, 26 to 29, 31, 32, 37 to 40, 42 & 43
Bass Boat.....	4
Berth.....	72
Bi-Color.....	1 to 4 & 22 to 27
Breakdown.....	37 to 42

### L - CONTINUED PAGE

Combination.....	5 to 7, 12, 13 & 22 to 27
Courtesy.....	64 & 65
Deck.....	10 & 66
Dredging Light.....	43
Dome.....	61 to 63
For Windshield	
Mounting.....	12 & 13
Mast.....	3, 10 to 13, 19, 22 to 24, 26 to 28, & 37 to 42
Masthead.....	10 to 13, 22 to 30 & 37 to 42
Meal & Absent.....	28
Not Under-Command.....	37 to 42
Pole.....	4 to 8, 12 to 17 & 19
Range.....	37 to 42
Searchlights.....	45 to 60
Side.....	5 to 7, 22 to 26 & 28 to 30
Signal.....	28 to 30 & 37 to 42
Spreader.....	66
Stern.....	8, 9, 22 to 26 & 28 to 30
Towing.....	25, 26 & 28 to 30
Utility.....	64 & 65
Vapor-Proof.....	64
Line Support Clips.....	78
Locks -	
Doors.....	159 to 167
Fender.....	133
Flush.....	158 to 161
Ladder.....	139
Mortise.....	163 & 167
Rim.....	159, 160 & 162 to 166
Window.....	173
Log Book.....	80
Lock Ventilators.....	84
Louver Ventilators.....	85

### M PAGE

Mast Lights.....	3, 10 to 13, 19, 22 to 24, 26 to 28 & 37 to 42
Masthead.....	10 to 13, 22 to 30 & 37 to 42
Meal & Absent Light.....	28
Mooring Bitts.....	117
Navigation Lights -	
For Vessels:	
Under 20 Meters (65.6 Ft.) in Length.....	1 to 31
Over 20 Meters (65.6 Ft.) in Length.....	36 to 43

### O PAGE

Oar -	
Leather & Buttons.....	137
Locks.....	136 to 138
Outlets -	
Cable.....	77
Water.....	96
Outrigger -	
Holders.....	177 to 180



## ALPHABETICAL INDEX

### O - CONTINUED PAGE

Kit .....	181
Pole Line Guides .....	181
Poles.....	182
Spreaders .....	182
Trolling Pins.....	181

### P PAGE

Paint Scraper .....	108
Palm, Sewing .....	139
Panels -	
Fuse .....	74 to 76
Switch .....	74
Piano Hinge .....	145
Pin, Trolling .....	181
Pipes, Rope Deck .....	118
Plates -	
Deck.....	90 to 94 & 96
Hawse Hole .....	117
Step.....	121 & 122
Plugs, Drain .....	105 to 107
Pole Holders -	
Replacement Bases .....	183 to 186
Replacement Poles .....	15
Vertical Height Chart .....	21
Pole Lights .....	4, 8, 12 to 17 & 19
Pole Sockets, Flag .....	123
Poles -	
Flag.....	123
Outrigger.....	182
Posts -	
Grab Rail .....	126
Stanchion.....	126
Pulleys.....	129
Pulls -	
Drawer .....	170 to 172
Flush.....	161, 163, 165 & 170 to 172
Pump Strainers .....	104

### R PAGE

Rail -	
Fittings .....	126 & 127
Hinges & Latches.....	127 & 145
Rails, Grab .....	125
Range Lights.....	37 to 42
Representatives.....	VI
Rigging Tube.....	108
Rim Locks .....	159, 160 & 162 to 166
Rim Latches .....	159, 160 & 162 to 166
Ring -	
Buoy Holders.....	127
Catches, Flush.....	169
Pulls .....	161 & 169 to 172
Rings, Hatch Lifting.....	169 to 171
Roller Tip Line Guide .....	181

### R - CONTINUED PAGE

Rope -	
Clamps .....	130
Guides.....	130 & 131
Pulleys .....	129
Rope Tighteners .....	131
Rowlocks.....	136 to 138

### S PAGE

Safety Cable .....	95
Scraper.....	108
Scuppers -	
Cockpit .....	97 & 98
Thru-Hull.....	97
Valve Assembly .....	97
Seacocks.....	101
Searchlights -	
Bulbs .....	54 & 79
Control Assemblies.....	46, 47, 51, 53, 57 & 59
Spare Parts.....	45, 54, 56, 59 & 60
Searchlights .....	45 to 60
Separator, Fuel .....	105
Shield, for Pole or Mast Lights.....	20
Side Lights.....	5 to 7, 22 to 26 & 28 to 30
Signal Lights, Portable or Fixed.....	28 to 30 & 37 to 42
Ski Towing Hook.....	121
Snap Hooks .....	133 to 135
Sockets -	
Boat Cover.....	176
Electric.....	31, 33, 44, 54, 55, 59 & 60
Fishing Rod .....	183 to 186
Flag Pole .....	123
Rowlock .....	137 & 138
Searchlight.....	54, 55, 59 & 60
Spreaders for Outrigger Poles .....	182
Spreader Lights.....	66
Spring Clamps.....	20 & 128
Springs for Dock Line .....	119
Spring, Tiller Rope .....	131
Staffs, Flag.....	123
Steps -	
Boarding.....	121 & 122
Folding .....	121 & 122
Step Plates.....	121 & 122
Stern -	
Lights.....	8, 9, 22 to 26 & 28 to 30
Pole Lights.....	4, 8, 12 to 17 & 19
Stops -	
Door.....	155
Window .....	173
Strainers -	
Fuel.....	105
Gasoline .....	105
Thru-Hull .....	103
Inlet .....	88, 89 & 103
Pump .....	104



## ALPHABETICAL INDEX

### S - CONTINUED PAGE

Water .....	88 & 89
Strap Hinges .....	151
Strap Cable .....	78
Switch Panels .....	74
Switches -	
Battery .....	68 to 71
Electric .....	68 to 74
Master .....	69
Panel .....	74
Swivel -	
Eye Pulleys .....	129
Eye Snaps .....	134 & 135

### T PAGE

"T" Hinges .....	151
Table Brackets .....	139
Table Leg Fasteners .....	173
Terminal Blocks .....	76
Thru-Hull Connections .....	98 to 101
Towing Hooks .....	121
Towing Lights .....	25, 26 & 28 to 30
Transom -	
Eyes .....	120
Stern Lights .....	8, 9, 22 to 26 & 28 to 30
Ventilators .....	84 & 85
Trim Hatch .....	145
Trolling Pin .....	181
Tube, Rigging .....	108
Tri-Color Lights .....	3
Turns Cupboard .....	157

### U PAGE

Universal Replacement Pole Light .....	15
Utility Hooks .....	174
Utility Lights .....	64 & 65

### V PAGE

Vapor Proof Fixtures .....	64
Ventilator -	
Cowl .....	81
Dorade .....	81
Gas Tank .....	82 & 83
Locker .....	84
Louver .....	85
Clam Shell Type .....	81
Transom .....	84

### W PAGE

Wardrobe Hooks .....	174
Warranty Information .....	II

### W - CONTINUED PAGE

Waste Fitting .....	91
Water Strainers .....	88
Water Strainer Graphs .....	89
Whistle .....	80
Window -	
Anti-Rattler .....	173
Handle, Sliding .....	172
Lock .....	173
Stop .....	173
Windshield -	
Adjusters .....	140 & 141
Keeper Plate .....	142 & 143
Pole Lights for .....	12 & 13
Wiper .....	130



# PERKO®

**We Make It Right. Right Here.**

**Street Address:**

**16490 N.W. 13th Avenue  
Miami, Florida 33169-5707**

**Mailing Address:**

**P.O. Box 64000  
Miami, Florida 33164-0510**

**Telephone Number:**

**305-621-7525**

**Fax Number:**

**305-620-9978**

**WE ARE MEMBERS OF THE  
FOLLOWING MARINE ASSOCIATIONS**



**NATIONAL MARINE  
MANUFACTURERS ASSOCIATION**



**AMERICAN BOAT AND YACHT COUNCIL, INC.  
CHARTER MEMBER**



**MARINE RETAILERS ASSOCIATION  
OF AMERICA**



**NATIONAL MARINE REPRESENTATIVES  
ASSOCIATION**



**NATIONAL MARINE DISTRIBUTORS  
ASSOCIATION**

**Manufacturer of Marine Lights, Hardware and Accessories**

**“The Difference is Distinctive®”**



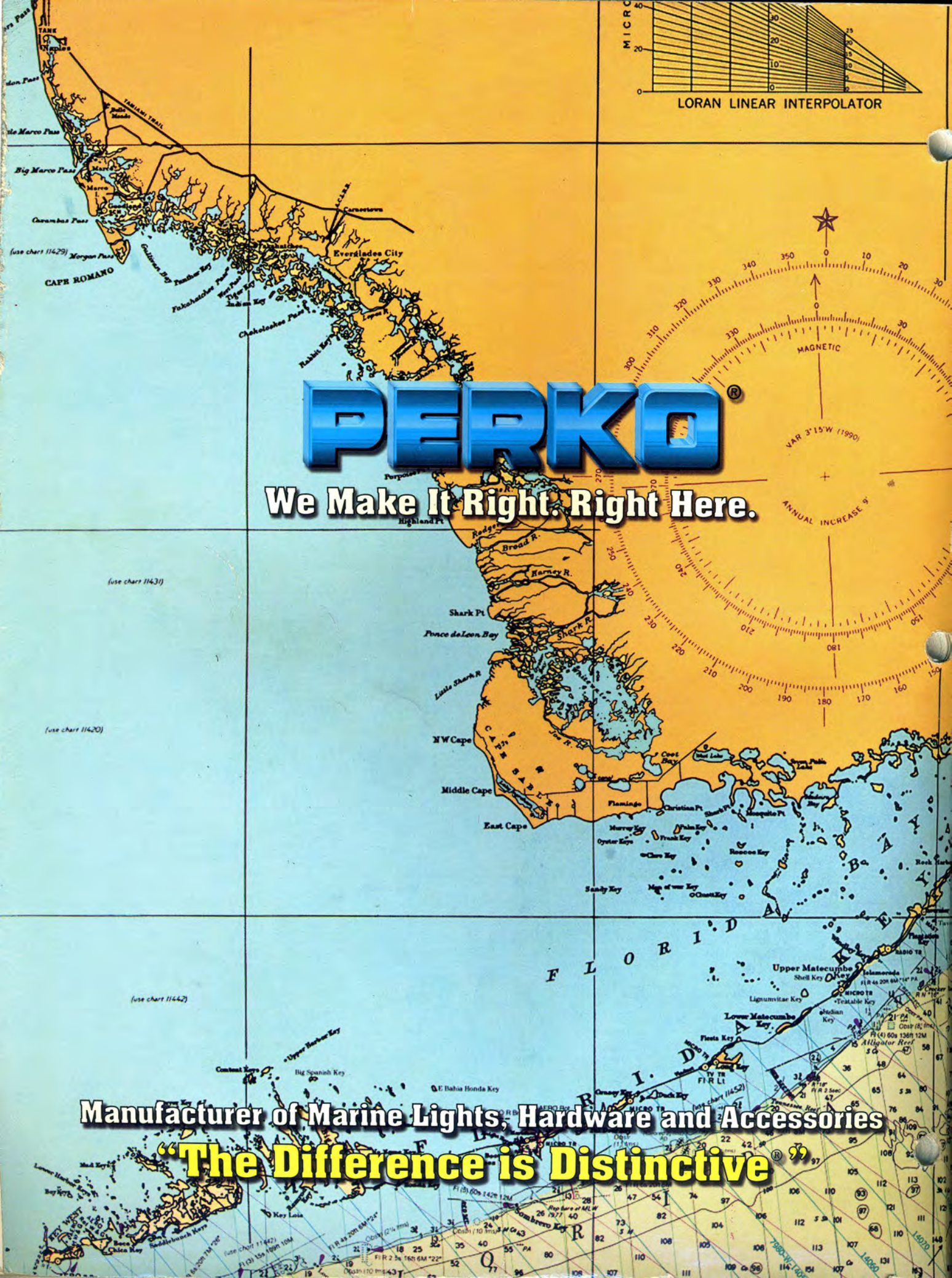
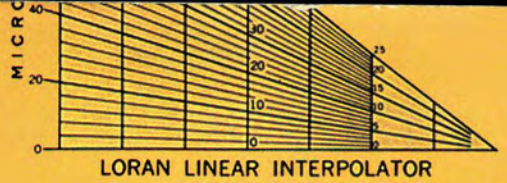

# PERKO®

**We Make It Right. Right Here.**

**Manufacturer of Marine Lights, Hardware and Accessories**

**“The Difference is Distinctive”**